

# Simulation and Optimization of a Naphtha Thermal Cracking Pilot Plant

**Shahrokhi, Mohammad\*<sup>+</sup>**

*Department of Chemical Engineering, Sharif University of Tech., P.O.Box 11365-9465 Tehran, I.R. IRAN*

**Masoumi, Mir Esmail; Sadrameli, Mojtaba and Towfighi, Jafar**

*Department of Chemical Engineering, Tarbiat Modarres University, P.O.Box 14155-4838 Tehran, I. R. IRAN*

**ABSTRACT:** *In thermal cracking plants, it is desired to apply an optimal temperature profile along the reactor to minimize the operation cost. In this article a simulator is developed by the use of a mathematical model, which describes the static operation of a naphtha thermal cracking pilot plant. The model is used to predict the steady state profiles of the gas temperature and product yields. Using a dynamic programming technique, an optimal temperature profile along the reactor is obtained. The effects of operating variables such as steam to hydrocarbon ratio (S/HC), coil outlet temperature (COT) and feed flow rate on product yield are investigated. Pilot plant simulation results are compared with the industrial data and the results indicate that they follow the same trend.*

**KEY WORDS:** *Thermal cracking furnace, Naphtha pyrolysis, Pilot plant, Simulation, Optimization*

## INTRODUCTION

The thermal cracking furnace is the key factor in both economical and smooth running of olefin plants. In addition, since the furnaces are the first step in the production process, disturbances that occur due to the furnace operation, affect the entire process. Raw materials in an olefin plant often ranges from ethane gas to heavy gas oils. Many furnaces have been modified to crack either liquid and gas feeds, or co-cracking of both gases and liquids, which are quite common.

The hydrocarbon feed and steam are preheated in the convection section of the furnace. The preheated gases

are then mixed and fed into the radiant section of the furnace where the temperature of the gas mixture raises rapidly to the desired cracking temperature. The cracking temperature range depends on the feed composition and for naphtha feed this range is 600 – 850 °C. In the radiant section, the hydrocarbon is cracked to a combination of olefins, aromatics, pyrolysis fuel oil and other heavier products. Upon leaving the radiant section of the furnace, the cracked gas is cooled rapidly to freeze the undesired reactions.

Flow rate of the feed, steam to hydrocarbon ratio

---

\* To whom correspondence should be addressed.

+ E-mail : Shahrokhi@Sharif.edu

1021-9986/03/1/27

9/\$/2.90

(S/HC) and coil outlet temperature (COT) are the important parameters affecting yield of ethylene. Measuring the cracked gas temperature in the coil outlet and manipulating the heat input to the furnace controls the coil outlet temperature. Dilution steam is added to the hydrocarbon feed. This has a positive effect on the olefin yield, and retards the buildup of coke, thereby extending the run life of the furnace [1].

To investigate the effects of different parameters on products yield, a pilot plant is designed and constructed. Before running the pilot a computer program is developed to simulate the system behavior. Increasing the reactor temperature increases the reactor yield and the rate of coke deposition. To obtain the optimal temperature profile, the objective function selected by Towfighi et al [2] has been considered.

The paper is organized as follows: in the first part, thermal cracking pilot plant is described briefly. Application of the developed computer program for simulating the pilot plant furnace is presented in the second part. In the third part, optimal temperature profile along the reactor is obtained by applying of dynamic programming approach and maximizing an objective function. Finally, the results of the simulations are compared with the industrial data.

### THERMAL CRACKING PILOT PLANT

The schematic diagram of the pilot plant considered for simulation is shown in Fig. 1. The reactor feed contains at least two streams: the hydrocarbon and the dilution steam. Liquid hydrocarbons and water are fed by means of two dosing pumps. The feed flow rates and S/HC ratio can be varied between 5 - 15 g/min and 0.3 - 0.8 respectively.

The furnace preheater consists of two electrical coils for heating water and hydrocarbon feeds. The reaction section is divided into eight zones, which can be heated independently to apply the desired temperature profile. The reactor is a tube with 1 m long made of inconel (alloy 600 HS 2), and has an internal diameter of 0.01 m. Temperature of different parts are measured as shown in Fig. 1. Detail specifications of pilot plant are presented in Table 1.

After cooling the reactor effluents to the appropriate temperature in a double pipe heat exchanger, liquids and tars are separated. A fraction of the product gas is then

Table 1: Basic data of the pilot plant

Section	Length (cm)	Diameter (cm)	#. of Zones	Type & #. of TCs	Power (kW)
Feed Preheater	100	10	1	K,3	13.2
Water Preheater	100	10	1	K,3	13.2
Furnace	100	10	8	K,18	17.6
Reactor	100	1		K,2	
Dowsing Pumps	Qmax = 3 lit/hr , Pmax = 10bar				0.1
Heat Ex.	Area = 0.04 m <sup>2</sup>				

Table 2: Specification of gas chromatograph system

Model: Varian Chrompack CP 3800			
Column	Type	Detector	Detected Gases
A	Capillary CP-CIL 5CB	FID	C2H4, C3H6, C4H6, ...
B	Packed Column	Methanizer & FID in series	CO, CO2

withdrawn for the analysis via a gas chromatograph (GC), while the rest is sent directly to the flare. Detail characteristics of GC are shown in Table 2. The system is connected to a computer through the interface cards for monitoring and control purposes [3].

### STATIC SIMULATION OF THE REACTOR

The heart of an ethylene plant is the cracking furnace. For finding an optimal operating strategy, it is crucial to check the influences of operating parameters, which can be satisfactorily calculated through the rigorous modeling. Rao, plehiers and Froment [4] simulated the reactor and the radiant box simultaneously. Other researchers [5-12] developed several packages.

In ethylene plant, naphtha is the most widely used feed material for the thermal cracking. Naphtha is a mixture of complex hydrocarbon materials, which ranges mostly from C<sub>5</sub> to C<sub>10</sub> paraffins. In the reactor, numerous cracking reactions occur to produce ethylene and propylene. The reaction mechanism of hydrocarbons in thermal cracking is free-radical chain reaction. In this work, a kinetic model, which considers 543 reactions for 90 species, has been used [13-14]. One-dimensional plug flow model is used to simulate the thermal cracking reactor. The governing mass, energy, and momentum balance equations for the cracking coil constitute the two-point boundary value problem and are given below:

$$\frac{dF_i}{dz} = \frac{\pi d_t^2}{4} \sum_{j=1}^{N_r} S_{ji} r_j \quad (1)$$

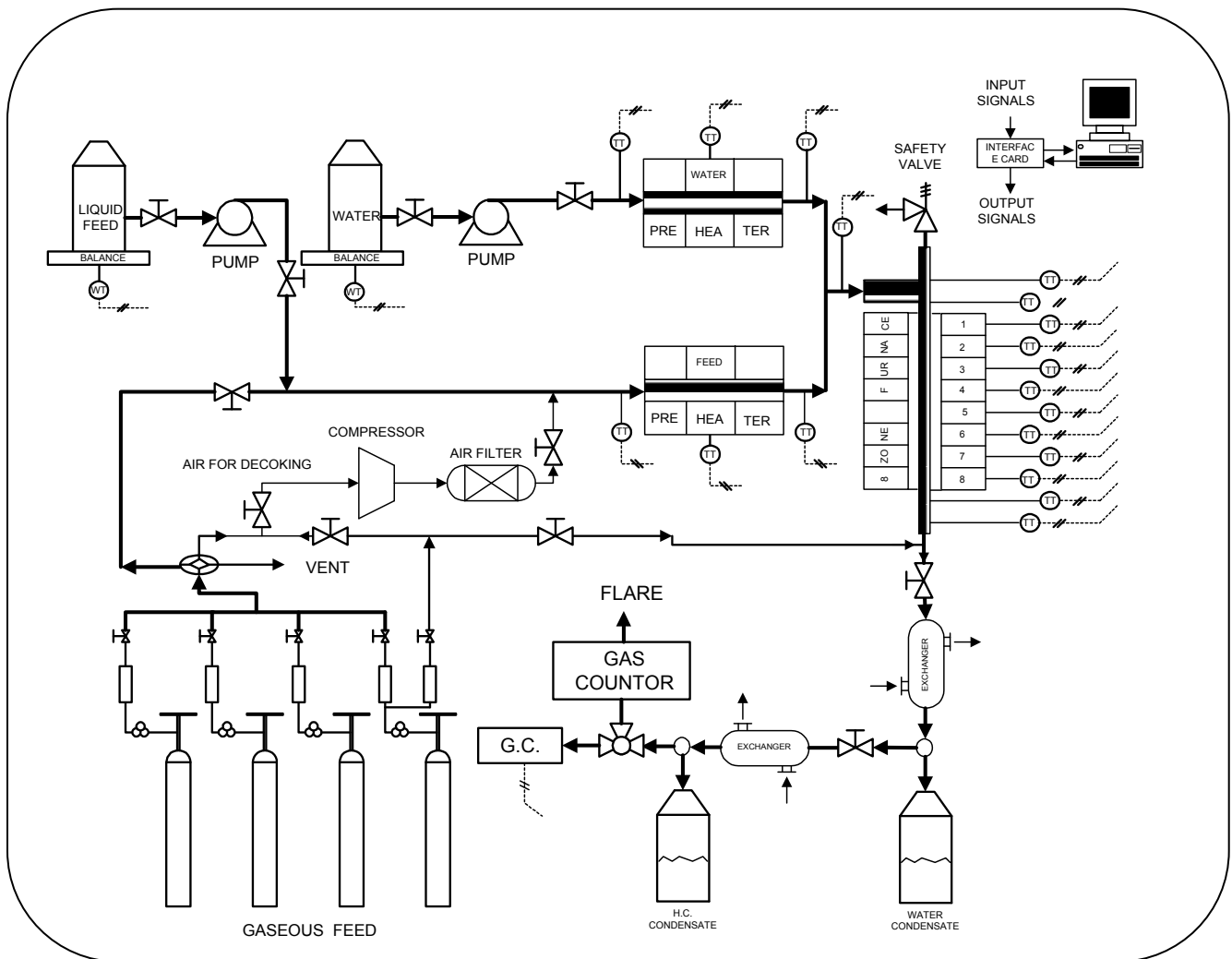

Fig. 1: Schematic diagram of the thermal cracking pilot plant

$$\frac{dT}{dz} = \frac{1}{Nc} \frac{[Q\pi d_t + \frac{\pi d_t^2}{4} \sum_{j=1}^{Nr} r_j (-\Delta H_j)]}{\sum_{i=1} F_i C_{p_i}} \quad (2)$$

$$\frac{dP_t}{dz} = \frac{\frac{d}{dz} \left( \frac{1}{M_m} \right) + \frac{1}{M_m} \left( \frac{1}{T} \cdot \frac{dT}{dz} + Fr \right)}{\frac{1}{M_m P_t} - \frac{P_t}{\alpha G^2 RT}} \quad (3)$$

where:

$$Fr = 0.092 Re^{-0.2} / d_t \quad (4)$$

These equations are highly nonlinear and therefore implicit Euler method [15] is used to solve them. The rate of coke formation has been taken into account [16-18].

The tuning parameters such as overall heat transfer coefficient and coking laydown factor can be adjusted to make the model prediction close to the actual data [19-20].

The developed software receives the feed specifications and provides product yield, gas temperature and pressure profile. The yield of each species is defined as the ratio of its mass flow rate to the total mass flow.

### SIMULATION RESULTS

For simulation, naphtha feed is used. Feed composition and operating parameters are given in Tables 3 and 4 respectively. In simulation, the program is run under three different conditions. In each run, two variables are fixed and the remaining one is varied. The furnace wall temperature is assumed to be constant.

Table 3: Naphtha feed composition (%wt)

No. of Carbons	n-Paraffins	Iso-Paraffins	Naphthens	Aromatics
4	0.22	2.64	----	----
5	25.22	17.94	4.19	----
6	14.88	23.41	2.82	2.0
7	1.67	3.27	----	0.97
8	----	0.57	----	0.2
Total	41.99	47.83	7.01	3.17

Table 4: Operating parameters

Operating Variable	Value
Inlet Temperature	600 °C
Inlet Pressure	3 atm. (abs.)
Feed Flow Rate	5 – 10 g /min
COT	830 – 900 °C
S/HC Ratio	0.2 – 0.9

Having this temperature and the overall heat transfer coefficient, the tube wall temperature is calculated through energy balance equation. The simulation results are tabulated in Table 5 and are shown in Figures 2 – 4.

To check the results, ethylene and propylene yields obtained through simulation are compared with the corresponding data taken from ARak Petrochemical Complex (ARPC). The results are shown in Figures 2a-4a. To show the results in the same figures, the industrial flow rates are divided by 16666.7, which is the ratio of industrial feed flow rate to the pilot feed rate.

Figures 2a and 2b show that increasing COT, will increase the ethylene yield and the rate of coke deposition. Due to these combined effects, the temperature profile along the reactor has an optimum. Figures 3a and 3b show that increasing S/HC ratio will increase the yield of ethylene and decrease the rate of coke deposition. Although this is favorable from production point of view, but the high value of S/HC ratio increases the cost. The optimum value of S/HC ratio which was reported in the literature, is about 0.6 – 0.7. Figures 4a and 4b show the effect of feed flow rate on ethylene yield and coke deposition. As shown in these figures, increasing feed flow rate, decreases the ethylene yield and coke deposition, which is due to decreasing of residence time. If hydrocarbon flow rate is increased, and S/HC ratio is decreased to keep the residence time constant, ethylene yield will be decreased [21]. Suitable

value of residence time which was reported in literature, is about 0.3 – 0.4 sec.

Fig. 2c shows the effect of COT on the gas temperature profile along the reactor. As mentioned before gas temperature has an optimal profile, which will be, discussed in the next section. Figures 3c and 4c show the effects of S/HC ratio and feed flow rate on gas temperature profiles. As can be seen, these variables have negligible effects on the gas temperature profiles at constant COT.

### OPTIMAL REACTOR TEMPERATURE

Increasing the reactor gas temperature increases the olefin yield and consequently the income. On the other hand, increasing temperature will also increase the rate of coke deposition in the inner tube surface of the cracking coil. The deposited coke reduces the olefin selectivity mainly because of increased pressure drop in the reactor [22-23]. An objective function, which combines the favorable higher product yield and the negative effect of the coking rate, is given by Towfighi et al. [2] They have introduced the following cost function:

$$Profit = Income - Cost \quad (5)$$

$$Income = \text{ethylene mass flow rate} \times \text{ethylene price} \times \text{yearly operating time} \quad (6)$$

or

$$Income = (F_{C_2H_4} \cdot M_{C_2H_4})(Pr_{C_2H_4})(t_0 - n_i t_i) \quad (7)$$

where  $t_0$  is the yearly operating time,  $t_i$  is the time required for decoking, and  $n_i$  is the number of reactor shutdowns. The labor and utility costs necessary for decoking operations are expressed as a fraction,  $l$ , of the term representing the benefit lost due to interruptions.

$$Cost = l(F_{C_2H_4} \cdot M_{C_2H_4})(Pr_{C_2H_4})(n_i t_i) \quad (8)$$

Combining eqs 5,7 and 8 yields:

$$Profit = (F_{C_2H_4} \cdot M_{C_2H_4})(Pr_{C_2H_4})[t_0 - n_i t_i (1+l)] \quad (9)$$

The frequency of decoking is proportional to the average rate of coke formation, which in turn, is a function of the temperature profile along the reactor. If

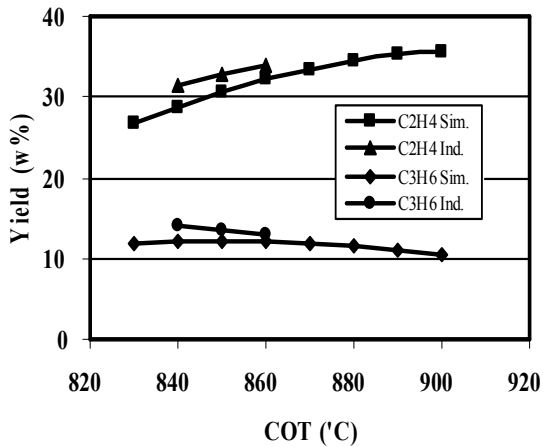

Fig. 2a: Effect of COT on the product yield

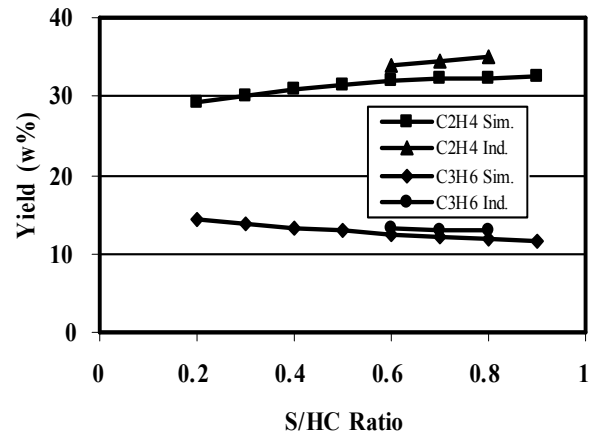

Fig. 3a: Effect of S/HC ratio on the product yield

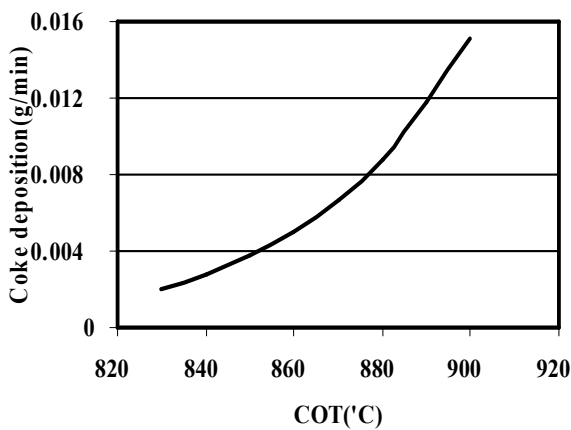

Fig. 2b: Effect of COT on the coke deposition

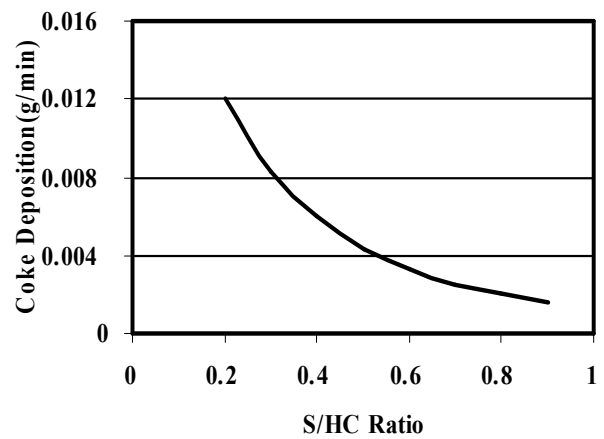

Fig. 3b: Effect of S/HC ratio on the coke deposition

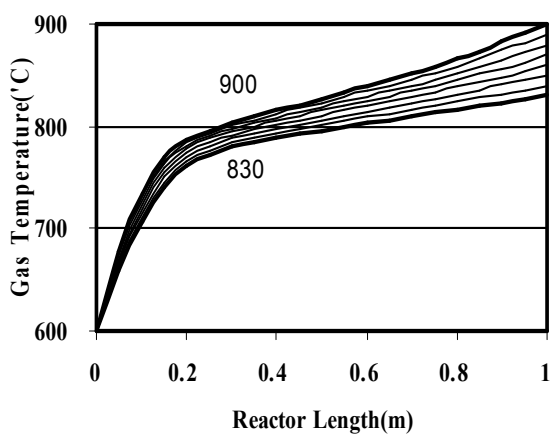

Fig. 2c: Temperature profile along the reactor at different COTs (830-900 °C)

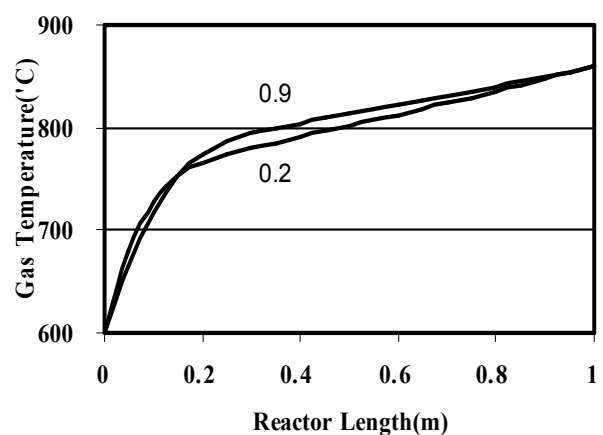

Fig. 3c: Temperature profile along the reactor at different S/HC ratios (0.2, 0.9)

Table 5: Static simulation results

COT (°C)	S/HC Ratio	Feed Flow Rate(g/min)	C2H4 Yield (%)	C3H6 Yield (%)	Coke Deposition. (g/min)	Furnace Wall Temp. (°C)
830	0.7	10	26.79	11.8	0.002031	913
840	0.7	10	28.81	12.07	0.002736	924.5
850	0.7	10	30.66	12.17	0.003738	935.5
860	0.7	10	32.15	12.1	0.004999	945.5
870	0.7	10	33.43	11.86	0.006702	954
880	0.7	10	34.4	11.51	0.008817	962
890	0.7	10	35.18	11.02	0.011725	970
900	0.7	10	35.68	10.48	0.015136	977
860	0.2	10	29.25	14.48	0.012084	930.5
860	0.3	10	30.2	13.85	0.008255	934
860	0.4	10	31	13.31	0.005978	937
860	0.5	10	31.5	12.86	0.004321	940.3
860	0.6	10	31.91	12.45	0.003266	943
860	0.7	10	32.15	12.1	0.002532	945.5
860	0.8	10	32.4	11.76	0.001991	947.5
860	0.9	10	32.53	11.45	0.001603	949.5
860	0.7	5	33.92	10.98	0.024894	888.5
860	0.7	6	33.64	11.6	0.015996	900
860	0.7	7	33.34	11.9	0.011268	912
860	0.7	8	32.98	12.05	0.008305	923.5
860	0.7	9	32.65	12.09	0.006461	935
860	0.7	10	32.15	12.1	0.005009	945.5
860	0.7	11	31.86	12.04	0.004170	956
860	0.7	12	31.49	11.96	0.003481	966
860	0.7	13	31.10	11.87	0.002949	975.5
860	0.7	14	30.69	11.76	0.002529	984.5
860	0.7	15	30.34	11.65	0.002217	993.5

for a given reference temperature profile the frequency of decoking and the average rate of coke formation are denoted by  $n_{ir}$  and  $\bar{r}_{cr}$  respectively, then we have:

$$\frac{n_i}{n_{ir}} = \frac{\bar{r}_c}{\bar{r}_{cr}} \quad (10)$$

where  $\bar{r}_c$  is the average rate of coke formation for a specific temperature profile and is given by:

$$\bar{r}_c = \frac{1}{L} \int_0^L r_c(z) dz \quad (11)$$

Combining eqs 10 and 11 yields:

$$n_i = \frac{n_{ir}}{L\bar{r}_{cr}} \int_0^L r_c(z) dz \quad (12)$$

Substituting eq 12 into eq 9 gives:

$$Profit = (F_{C2H4} \cdot M_{C2H4}) (Pr_{C2H4})(t_0)^\times$$

$$[1 - \beta(1+l) \int_0^L r_c(z) dz] \quad (13)$$

where:

$$\beta = \frac{n_{ir} t_i}{t_0 \bar{r}_{cr} L} \quad (14)$$

When the above objective function is maximized using a dynamic programming technique, the optimal temperature profile along the reactor is obtained. Details of this solution technique are described in the literature [24-28]. The optimal gas temperature profile obtained through simulation is shown in Fig. 5. As can be seen, the optimal COT is 877.34 °C. At this condition the ethylene yield in the reactor effluent, is 33.737. It should be noted that the above optimization is carried out under specified feed flow rate, S/HC ratio and feed pressure and temperature. The corresponding selected values are 10 g/min, 0.7, 3 atm. and 600 °C respectively.

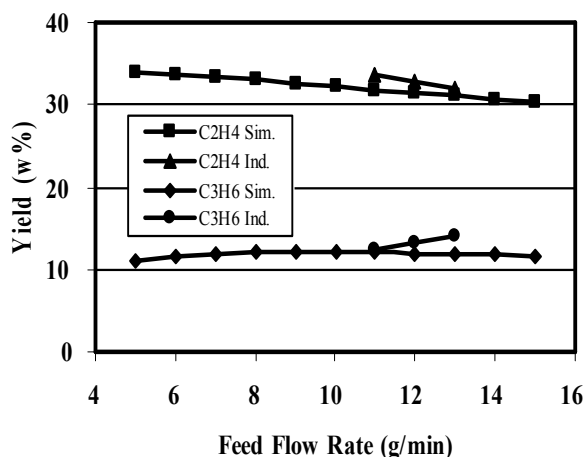

Fig. 4a: Effect of feed flow rate on the product yield

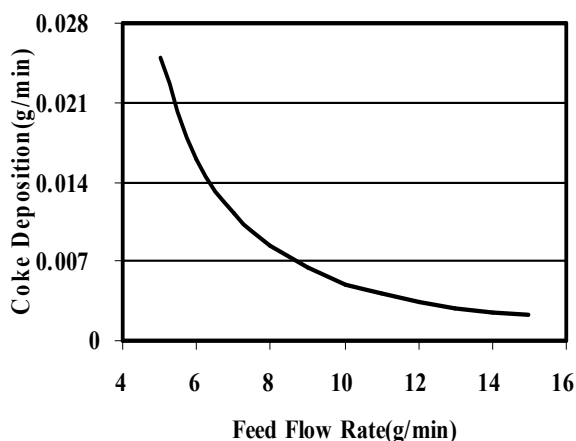

Fig. 4b: Effect of feed flow rate on the coke deposition

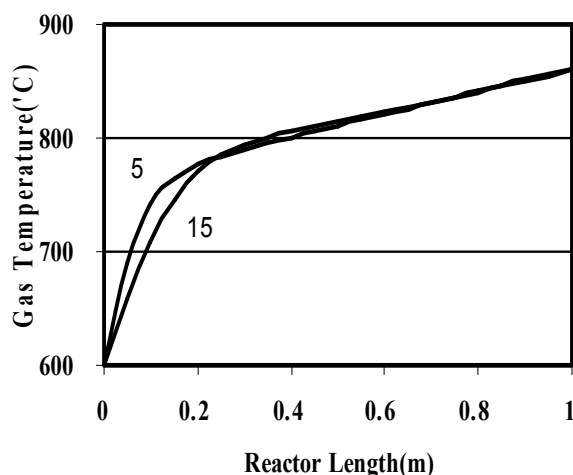

Fig. 4c: Temperature profile along the reactor at different feed flow rates (5, 15 g/min)

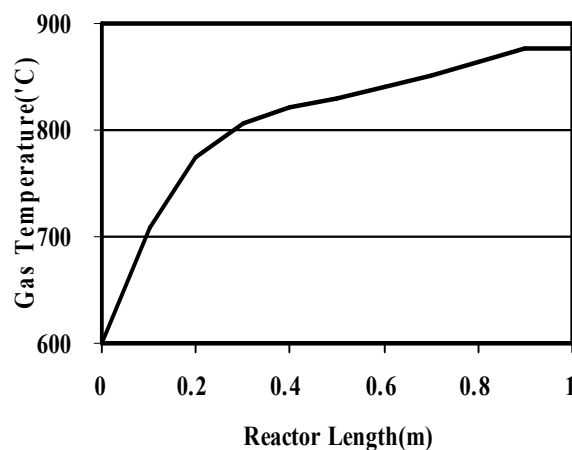

Fig. 5: Optimal gas temperature profile along the reactor

## CONCLUSION

Based on the cracking kinetics proposed in the literature a computer program for simulating the behavior of a thermal cracking pilot is prepared. The developed software is used to simulate the static behavior of the process and to determine the effects of different parameters on the product yield. Simulation results indicate that increasing the temperature, increases the ethylene yield and the rate of coke deposition, therefore it has an optimal profile. Increasing S/HC ratio increases the ethylene yield and decreases the coking rate. At constant S/HC ratio, increasing feed rate, decreases the ethylene yield. At constant COT, variations of S/HC ratio and feed flow rate have no significant effect on the gas temperature profile. The effects of S/HC ratio, feed flow

rate and COT on the ethylene yield show the same trends both for simulation and the industrial one. The discrepancies refer to the reactor configuration in pilot plant and industrial cases. Finally based on an objective function and using dynamic programming technique, the optimal gas temperature profile along the pilot reactor is obtained.

## Future Work

The optimal temperature profile will be applied to the pilot and the results will be compared with simulation output.

## Acknowledgments

The authors are grateful to Mr. A. Nedjati for preparation of the simulation software.

**Nomenclature**

Cp	heat capacity (J/mole K)
$d_t$	reactor diameter (m)
F	molar flow rate (mole/sec)
$F_r$	friction function
G	total mass flux (kg/m <sup>2</sup> sec)
$\Delta H$	heat of reaction (J/mole)
L	reactor length (m)
M	molecular weight (g/mole)
Nc	number of components
Nr	number of reactions
Pr	price
$P_t$	total pressure (atm. abs)
Q	heat flux (J/m <sup>2</sup> sec)
r	reaction rate (mole/lit.sec)
R	gas constant (J/mole K)
Re	Reynolds number
$S_{ji}$	stoichiometric coefficient of component i in reaction
T	gas temperature inside the reactor (K)
z	reactor length coordinate (m)

**Greek Letters**

$\alpha$	constant ( atm/ Pa )
----------	----------------------

**Subscripts**

i	index for component i
j	index for reaction j
m	mixture

Received: 4<sup>th</sup> March 2002 ; Accepted : 9<sup>th</sup> December 2002

**REFERENCES**

- [1] Cugini, J., *Symposium on Characterization of Thermodynamics and Transport Properties of Polymer System, New Orleans, LA, USA, Apr.* (1986).
- [2] Towfighi, J., Karimaei, M. and Karimzadeh, R., *Scientia Iranica*, **5**, 1(1998).
- [3] Towfighi, J., Shahrokhi, M., Sadrameli, M., Masoumi, M.E. and Niaei, A.G., *7<sup>th</sup> National Iranian Chemical Engineering Conference Proceeding*, **4**, 234(2002).
- [4] Rao, R.M.V., Plehiers, M.P. and Froment, G.F., *Chem. Eng. Sci.*, **43**, 1223(1998).
- [5] Froment, G.F., Van de Steen, B.O., Berghe, P.J.V., and Goossens, G.A., *AIChE J.*, **23**, 93(1977).
- [6] Froment, G.F., Van de Steen, B.O., Berghe, P.J.V., and Goossens, G.A., *AIChE J.*, **23**, 93(1977).
- [7] Dente, M., Ranzi, E., Barendregt, S., and Goossens, G.A., *AIChE 72th Annual Meeting*, Nov. (1979).
- [8] Dente, M., Ranzi, E. and Goossens, G.A., *Comp. Chem. Eng.*, **3**, 61(1979).
- [9] Towfighi, J., Nazari, H. and Karimzadeh, R., *APCCHE / CHEMECA 93, Melbourne, Australia*, **3**, 337(1993).
- [10] Joo, E., Lee, K., Lee, M. and Park, S., *Comp. Chem. Eng.*, **24**, 1523(2000).
- [11] Goethem, M.W.M., Kleinendorst, F.I., Leeuwen, C.V. and Velzen, N.V., *Comp. Chem. Eng.*, **24**, 905(2001).
- [12] Joo, E. and Park, S., *Ind. Eng. Chem. Res.*, **40**, 2409(2001).
- [13] Towfighi, J., Nazari, H., "Modeling and Simulation of Light Hydrocarbons Thermal Cracking by radical Mechanism", *M.Sc. Thesis, Tarbiat Modares University*, (1992).
- [14] Towfighi, J., Karimzadeh, R., "Modeling and Simulation of Naphtha Thermal Cracking Reactors by Radical Mechanism", *M.Sc. Thesis, Tarbiat Modares University*, (1992).
- [15] Thomas, P., "Simulation of Industrial Process", Butterworth, (1999).
- [16] Kopinke, F.D., Zimmermann, G. and Nowak, S., *Carbon*, **56**, 117(1988).
- [17] Kopinke, F.D., Zimmermann, G., Reyners, G. and Froment, G.F., *Ind. Eng. Chem. Res.*, **32**, 56(1993).
- [18] Kopinke, F.D., Zimmermann, G., Reyners, G. and Froment, G.F., *Ind. Eng. Chem. Res.*, **32**, 2620(1993).
- [19] Huntrods, J., Nighswander, A.K.M. and Behie, L.A., *Chem. Eng. Res. Des.*, **67**, 632(1989).
- [20] Towfighi, J., Niaei, A. and Hoseini, S., *Iranian J. Sci. & Tech., Trans. B*, **26**, 275(2002).
- [21] Eliceche, A.M., Petracci, N.C., Hoch, P. and Brignoli, A., *Comp. Chem. Eng.*, **19**, S223(1995).



Simulation and Optimization...

- [22] Newberger, M.R. and Kadl, R.H., *AIChE Journal*, **17**, 1381(1971).
- [24] Shahrokhi, M. and Nedjati, A., Optimal Temperature Control of a Propane Thermal Cracking, *Ind. Eng. Chem. Res.*, **41**, 6572 (2002).
- [25] Shahrokhi, M. and Nedjati, A., "Temperature Control of Olefin Thermal Cracking Reactor", *M.Sc. Thesis, Sharif University of Technology*, (2001).
- [23] Ranzi, E., Dente, M., Pierucci, S. and Barendregt, S., *Ing. Chim. Ital.*, **17**, 76 (1981).
- [26] Wilson, J.T. and Belanger, P.R., *IEEE Transaction on Automatic Control*, **17**, 756 (1972).
- [27] Luus, R., *Int. J. Control*, **52**, 239(1990).
- [28] Sargent, R.W.H., *Journal of Computational and Applied Mathematics*, **124**, 361(2000).