

Iran University of  
Science and Technology

## International Journal of Automotive Engineering

Journal Homepage: [ijae.iust.ac.ir](http://ijae.iust.ac.ir)

## Modeling of a Novel Hybrid Drivetrain Based on Hybridized Ball Continuously Variable Transmission

Arian Afrabandpey<sup>1</sup>, Hashem Ghariblu<sup>1\*</sup><sup>1</sup> Department of Mechanical Engineering, University of Zanjan, Zanjan, Iran.

## ARTICLE INFO

## Article history:

Received : 5 Feb 2020

Accepted: 30 April 2020

Published: 1 May 2020

## Keywords:

Ball continuously variable  
transmission

Hybrid system

Operation mode

Torque

## A B S T R A C T

To reduce the harmful effects of fuel based engines new technologies in automotive industries have introduced. Combination of novel ball continuously variable transmission and hybrid technologies with the advantages of optimum controlling of power sources in the vehicle are the main topic of this paper by preparing a model of transmission using GT-Suite software. In order to determine the operation and responses of the proposed transmission, different operational modes, along with different inputs in term of speed, torque and ratio are presented. This research successfully demonstrates a new type of transmission which is developed to enjoy the benefits of combining technologies in vehicle drivetrain that features high torque capacity and desirable drivability. Main achievement of this paper is to show the operational modes of this system as well as ability to mode alteration during vehicle operation. Various steady and transient modes are studied in this paper using multi body modeling and it shows HBCVT can eliminate most limitation of parallel hybrid systems.

\*Hashem Ghariblu  
Email Address: [ghariblu@znu.ac.ir](mailto:ghariblu@znu.ac.ir)  
<http://tlx.doi.org/10.22068/ijae.10.2.3233>



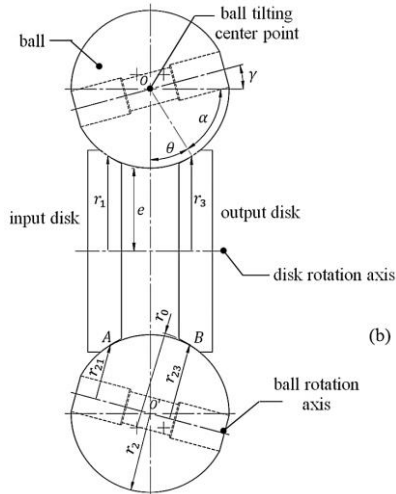

Figure. 2. Schematic of BCVT [17].

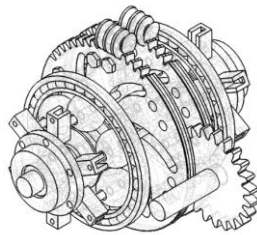

Figure. 3. Model of BCVT with double cavity

Despite advantages of BCVT like high torque capacity, it has some drawbacks in gear ratio interval which known as ratio spread. To eliminate the requirement of wider ratio, in this paper an AMT gearbox with two gear sets is employed together with BCVT system.

Aside from CVTs, use of hybrid technology are going to increase in passenger vehicles. Combining an electric motor or generator (EM/G) to ICE of a passenger car is a temporary solution to reduce FC by downsizing and down speeding ICE at partial loads which is a major advantage. The study of combined hybrid transmission in this paper was evaluated using the commercial software GT-Suite.

The main aim of this paper is to simulate a novel hybrid BCVT (HBCVT) transmission and show the operation of this transmission in different operations and conditions. The following sections have been organized in this manner. In section 2, the transmission modeling methodology have presented which includes HBCVT configuration, power flow arrangement and operation modes. Next section, describes dynamics of this drivetrain and results of its operation and mode alteration described in section 4.

## 2. Transmission Configuration, Modelling and Layouts

BCVT is a new generation of power transmission systems, which is developed to enjoy benefits of CVTs, like simpler speed/torque change, fuel efficiency and reduced emissions. As discussed earlier, a BCVT has structurally constraint in its gear ratio interval. Thus to reach a wider gear ratio, here we introduce a new power transmission system (PTS) that combines a BCVT with an AMT to employ it in a hybrid power transmission, which is named as HBCVT.

### 2.1. New HBCVT Configuration

Figure. 4 represents a schematics of the designed mechanism for HBCVT. This system contains two aligned input shafts from engine (IS1) and EM/G (IS2), one output shaft (OS), one middle shaft (MS), two gear selectors (dog clutch), one single cavity BCVT and three pairs of gears. In this transmission, ICE is linked to IS1 through the main clutch and EM/G connects the IS2 directly or through a gear pair. The engine is connected through the IS1 and MS via two gear pairs. These gear pairs are controlled by gearshift sleeve S1, which can engage and disengage gearwheels and shaft via dog clutches. Moreover, IS1 and IS2 are aligned with each other and can engage by positioning of the gearshift sleeve S2. MS is connected to the input disc of BCVT. Also, output shaft of BCVT is directly connected to the OS.

By shifting the dog clutch S2 to left, IS1 and IS2 engage with each other. This engagement is named as P2 (parallel in second architecture) hybrid mode. In P2 mode, ICE is able to work in near optimal condition, and produce the power output that is more than vehicles' power demand. Hence, in the P2 mode, EM/G works as a generator to store ICEs excess power in the batteries. Contrary, if S2 is shifted to the right, PTS works in the P3 hybrid mode arrangement (parallel in third architecture). In this mode, IS2 is connected to the OS to shift the ICE power to OS through IS1, MS and BCVT.

The HBCVT supports five different modes of operation for hybrid powertrain system that will be discussed in the following.

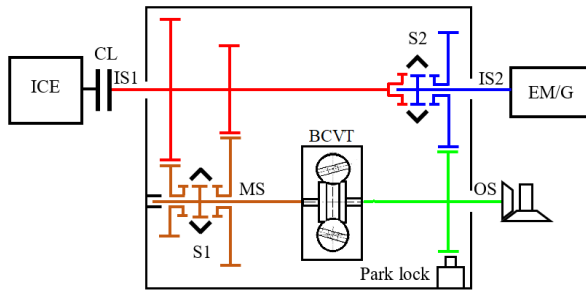

Figure. 4. Schematics of HBCVT mechanism

## 2.2. Power Flow Arrangement

Figure. 5 depicts a schematic diagram of power flow in a typical HBCVT. In the electric mode, ICE is off and disengaged from transmission by main clutch. EM/G can exchange power with wheels (traction or regeneration) and ICE through IS2. On the other hand, connection of ICE to OS is via AMT and BCVT in series, to adjust speed-torque specifications, according to the vehicle needs. Moreover, ICE can send power directly to EM/G in P2 architecture. Finally, the combination of the power of both sources can be applied to the OS in P3 architecture, when more traction for the vehicle is needed.

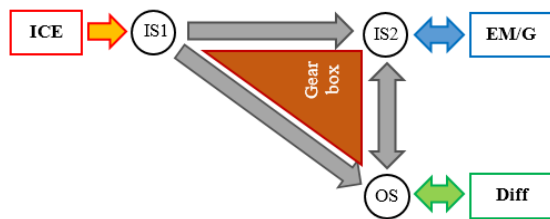

Figure. 5. Power flow in the HBCVT

In Table 1, gear selection method for different modes of hybrid system is presented. In the full electric mode, dog clutch S1 stays in the middle position which cause the separation of IS1 and MS, while S2 shifts to the right to connect EM/G to OS, directly. As noted earlier, this transmission combined an AMT and a BCVT for hybrid application. The AMT section of this transmission only has two gear set and the position of dog clutch S1 indicates the target gear number. Accordingly, when S1 shifted to left, the lower gear is selected. This gear set is appropriate

for lower speeds and higher torque and vice versa when S1 is shifted to right, causes higher speed and lower torque at OS. According to (1), the ratio multiplication of AMT ( $i_{AMT}$ ) and BCVT ( $i_{BCVT}$ ), indicates the overall ratio of transmission ( $i_{tran}$ ) before differential.

$$i_{tran} = i_{AMT} \times i_{BCVT} \quad (1)$$

Also, in the P3 mode, the gear ratio of transmission for ICE is calculated trough (1).

In a case that driver decides to cruise only with ICE, dog clutch S2 shifts to mid (neutral) position to disengage the connection of EM/G with OS. Contradictory with many hybrid parallel transmissions, this transmission is able to charge the batteries through ICE while it is stopped. In this condition, ICE directly drives the EM/G in opposite direction in full electric mode, without need a separate reverse gear arrangement.

Table 1. Selector arrangement in operation modes.

Mode	S1			S2		
	L	M	R	L	M	R
Full electric		•				•
Hybrid P2	•		•	•		
Hybrid P3	•		•			•
Full combustion	•		•		•	
Steady charging		•		•		

## 2.3. Gear Ratio and Ratio Spread

Determining the ratio spread and gear ratio is another important design step for this PTS. According to (2), the ratio spread is the ratio of the lowest gear set ratio  $i_{tranLow}$  to the highest gear set ratio,  $i_{tranHigh}$ . The overall ratio spread directly affects the range of speeds that the transmission provides to the vehicle and the gear ratio between each gear pair affects the acceleration rate of the vehicle at each gear change step.

$$Ratio\ Spread = i_{spread_{tran}} = \frac{i_{tranHigh}}{i_{tranLow}} \quad (2)$$

According to (3), the ratio spread of HBCVT is produced by multiplying of ratio spreads of BCVT denoted by  $i_{spread_{BCVT}}$  and AMT denoted by  $i_{spread_{AMT}}$ .

$$i_{spread_{HBCVT}} = i_{spread_{BCVT}} \times i_{spread_{AMT}} \quad (3)$$

Considering a two speed transmission for AMT and a smooth and continuous power transmission of HBCVT in swapping the gear ratios, (4) must be satisfied,

$$i_{AMT_{Low}} \times i_{BCVT_{High}} = i_{AMT_{High}} \times i_{BCVT_{Low}} \quad (4)$$

where  $i_{AMT_{Low}}$  and  $i_{AMT_{High}}$  are lower and higher ratios of AMT section and  $i_{BCVT_{High}}$  and  $i_{BCVT_{Low}}$  represent the higher and lower ratios of BCVT section, respectively. Since the typical ratio spread of CVTs for passenger vehicles are up to 8, according to [18, 19, 20 and 21] which discuss the aspects of various type of CVTs, the combination of AMT and BCVT must give the same ratio spread. Therefore, by rewriting (3) and replacing (4), spread ratios of AMT and BCVT are (6) and (7):

$$i_{spread_{HBCVT}} = i_{spread_{BCVT}} \times i_{spread_{AMT}} = \frac{i_{BCVT_{High}}}{i_{BCVT_{Low}}} \times \frac{i_{AMT_{High}}}{i_{AMT_{Low}}} \quad (5)$$

$$i_{spread_{HBCVT}} = \frac{\left(\frac{i_{AMT_{High}} \times i_{BCVT_{Low}}}{i_{AMT_{Low}}}\right)}{i_{BCVT_{Low}}} \times \frac{i_{AMT_{High}}}{i_{AMT_{Low}}} = \left(\frac{i_{AMT_{High}}}{i_{AMT_{Low}}}\right)^2 \quad (6)$$

$$i_{spread_{HBCVT}} = \frac{i_{BCVT_{High}}}{i_{BCVT_{Low}}} \times \frac{\left(\frac{i_{AMT_{Low}} \times i_{BCVT_{High}}}{i_{BCVT_{Low}}}\right)}{i_{AMT_{Low}}} = \left(\frac{i_{BCVT_{High}}}{i_{BCVT_{Low}}}\right)^2 \quad (7)$$

Given the recent equations, it is simply possible to consider the spread ratio of HBCVT equal to 8, considering in a BCVT, the tilting angle of balls determine the ratio of transmission and taking the losses of this transmission into account [17]. Hence, the overall speed ratios BCVT and each gear pair if PTS are summarized in Table 2.

Table 2. Speed ratio of gear pairs and BCVT

	Transmission	Ratio
AMT	First gear	2.828
	Second gear	1
BCVT	Highest	1.682
	Lowest	0.595
EM/G	IS2 to OS	1
	IS2 to IS1	1

2.4. Operation Modes

As stated in Table 1, HBCVT operates in five different modes. In the EV mode, batteries are able to deliver power demand of the vehicle through the EM/G. In this mode, ICE is off, and the main clutch is disconnected. When, power demand of the vehicle is more than maximum power that can be individually delivered by the EM/G or batteries State of Charge (SOC) is low, ICE starts to work via coordinated drivetrain control. When speed shifting in hybrid modes is needed, ICE, EM/G, main clutch and PTS are controlled to achieve smooth and continuous speed/torque change. The HBCVT introduces a unique PTS, and supports two different P2, or P3 hybrid modes.

2.4.1. EV mode

When hybrid control unit (HCU) of vehicle allows EM/G to drive vehicle without startup of engine, the main clutch will be disconnected. EM/G torque can drive vehicle with one paths through IS2 to OS by shifting S2 to right side and S1 to middle according to Figure. 6. In the EV driving mode, power demand of the vehicle is less than the output power of EM/G and SOC in battery is high enough.

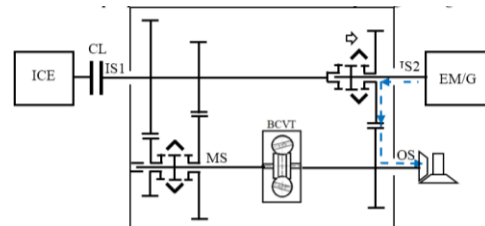

Figure. 6. HBCVT in EV mode

2.4.2. ICE mode

Due to hybrid systems' beneficial operation condition in terms of fuel economy, performance and emissions, driving a hybrid vehicle in ICE mode is rarely take places. However, in some cases driver might prefer to drive in the ICE mode; e.g. when electric or control system are not operated properly. This ability can also be beneficial, if driver needs high power demand, but batteries SOC is very low. Driving in this mode continues until vehicle can recharge the batteries to drive in hybrid mode. As it is shown in Figure. 7, in this mode, power flows through IS1 to MS and OS with choosing suitable AMT

ratio by S1 and then CVT ratio. In this mode S2 is in middle position.

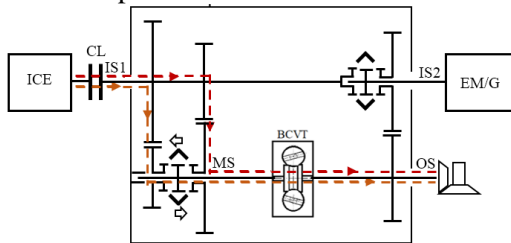

Figure 7: HBCVT in ICE mode

### 2.4.3. P2 and P3 Hybrid mode

The ability of mode alteration in parallel hybrid vehicles is significantly important. In HBCVT, HCU must predict the best mode by measuring the SOC and power demand. In hybrid mode, combined power from ICE and EM/G flows to the wheels. Usually, vehicle hybrid mode P3 is preferred, except during battery charging that HCU selects P2 hybrid mode.

As it is seen in Figure 8, in the P2 mode, by shifting S2 to left, some portion of ICEs Power is transferred to the vehicle wheels through the MS and OS. The excess power produced by ICE is shifted to EM/G as generator through IS1, to charge the batteries. In this mode, speed of EM/G is equal to ICE. But, vehicle desired speed by ICE rotation is selected by appropriate AMT, BCVT ratios according to (8). On the other hand, in P3 architecture, power of ICE pass through IS1 and MS and after BCVT combines with power of EM/G in OS. In P3 mode, S2 must shift to right, as demonstrated in Figure 9. In P3 mode, the speed of EM/G are related to the speed of wheels by final drive ratio and related to the speed of ICE by AMT and BCVT ratios according to (9).

$$\begin{cases} \omega_{ICE} = \omega_{EM/G} \\ \omega_{wheel} = \omega_{ICE} \times i_{AMT} \times i_{BCVT} \times i_{Diff} \end{cases} \quad (8)$$

$$\begin{cases} \omega_{EM/G} = \omega_{ICE} \times i_{AMT} \times i_{BCVT} \\ \omega_{wheel} = \omega_{EM/G} \times i_{Diff} \\ \omega_{wheel} = \omega_{ICE} \times i_{AMT} \times i_{BCVT} \times i_{Diff} \end{cases} \quad (9)$$

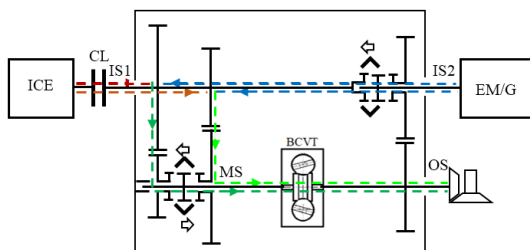

Figure 8. HBCVT in P2 architecture of hybrid mode

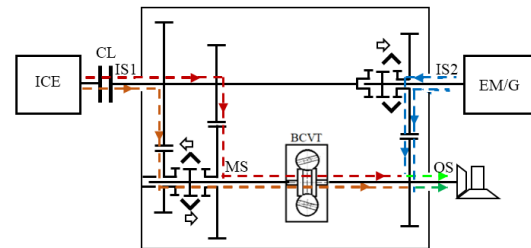

Figure 9. HBCVT in P3 architecture of hybrid mode

### 2.4.4. Battery charging mode (Stopped vehicle)

In many parallel hybrid transmissions, due to the lack of direct connection between ICE and EM/G, battery recharges only when vehicle is moving.

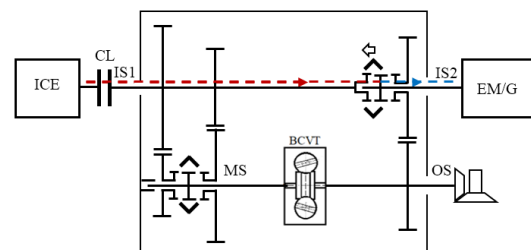

Figure 10. HBCVT in battery charging mode, when vehicle is stopped

However, as shown in Figure 10, in HBCVT, by shifting S1 to the middle state, and S2 to left, power flows from ICE with IS1 and IS2 to EM/G when vehicle is stopped.

## 3. Modelling of Hybrid Drivetrain

### 3.1. Dynamics

As it is described in Section 3, HBCVT operates in different operation modes, that results high flexibility for vehicle motion. In this section, dynamics of whole system in each operating mode is analyzed to identify the physical principles of mode transition.

A multi lump body model, is usually used to analyze dynamics of drivetrain system. In [22], such a model used to presents the kinematic and dynamic analysis of a power-shift of an AMT system. In [23], a multibody system is employed to simulate the mode transitions of series-parallel HEV and in [24] multi body model is hired to check the drivability of parallel HEV during mode transition. The model of this paper is composed of four types of elements including

moment of inertia with imposed torques and frictions, shafts, gear pairs with respective ratios, clutch and selectors. External retarding force  $F_r$  which is a combination of tire friction ( $M_V \cos \alpha \mu$ ), air drag ( $\frac{1}{2} C_D A \rho_{air} V^2$ ) and parallel component of gravity ( $M_V \sin \alpha$ ) force is shown in (10).

$$F_r = M_V \sin \alpha + M_V \cos \alpha \mu + \frac{1}{2} C_D A \rho_{air} V^2 \quad (10)$$

Output torque of transmission  $T_{Out}$  overcomes  $F_r$  and accelerates of vehicle and all rotational moments of inertias including 4 wheels, as shown in (11) and (12).

$$M_{eff} a_V = \frac{T_{out}}{R_w} - F_r \quad (11)$$

$$M_{eff} = M_V + 4 \frac{J_w}{R_w^2} \quad (12)$$

where  $R_w$  is the radius of wheels and  $M_{eff}$  is the mass of vehicle with added effect of inertia factor of wheels according to (12).

A gearshift in AMT involves state changes of all drivetrain components and internal parts, while mode changing extend this changes to the dynamics of ICE and EM/G. Therefore, primary challenges in a gearshift includes fluctuation in output torque before engagement of main clutch which cause variation in speed.

### 3.2. Powertrain modeling and control logic

To check the operation of HBCVT, a simulation model is built and a PID based control strategy is developed to achieve smoother mode transition and gearshifts.

Driveline of HBCVT is modeled using GT-Power software as shown in Figure. 11. As stated before, this transmission includes two pairs of gears with synchronizers for AMT, a set of gears with synchronizer for EM/G connection, a BCVT, one clutch. Also, an electric motor with a predefined torque-rpm map is employed instead of ICE, and another electric motors as EM/G. Meanwhile, another EM/G, coupled with a flywheel is connected to OS, to simulate the road behavior, dissipations and inertia of vehicle. To control entire system, a controller employed which uses two inputs (mode of driving and gear ratio) for transmission and 3 inputs to control the behavior of electric motors.

By increasing vehicle speed, HCU monitors SOC and vehicle power demand to choose the best driving mode and transmits it to transmission control unit (TCU). Then, TCU uses the vehicle speed to select an appropriate gear ratio, considering best operational state of ICE to manage vehicle's fuel economy. By determining ratios of AMT and BCVT, the dog clutches S1 and S2 are shifted appropriately accommodated with the operation mode. Also, actuator of clutch acts based on the selected operational mode. If gear ratio was greater than one, S1 shifts to left to select the first gear and BCVT ratio is calculated, by dividing overall gear ratio by the first gear ratio. Else, if overall gear ratio was less than one, S1 shifts to right to choose the second gear pair and BCVT ratio is calculated by dividing overall gear ratio into AMTs 2<sup>nd</sup> gear ratio. During gear changing in AMT or EM/G side, the clutch is disengaged to separate the ICE from HBCVT, like manual transmissions.

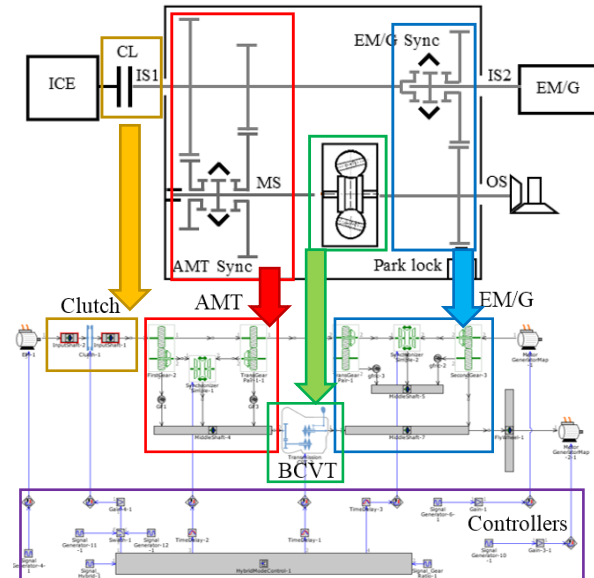

Figure. 11. Representation of elements of HBCVT model in GT-Suite software

Other considerations must be taken into account by selecting the HBCVTs operation mode, as

- Switching from pure electric mode (EV) to ICE mode, selected only when battery is depleted or power demand is higher than maximum power of ICE.
- EV mode is selected when SOC is high and power demand is less than maximum power of EM/G.

The trade of among level of SOC, power demand and driving mode are depicted in Figure. 12. Accordingly, allowable mode alteration presented in Table 2, that should be considered in the HBCVTs operation and modelling. Therefore, transmission must be able to switch between all modes considering limitations of Table 3. Moreover, since the ability of battery charging is in stopped or parked condition of vehicle, it is not mentioned in simulation results, presented in the next section.

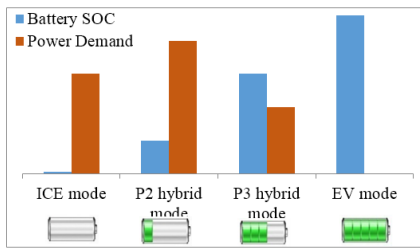

Figure. 12. Trade of level of SOC, power demand and driving mode

Table 3. Allowable mode alteration during vehicle operation

	EV	ICE	P2 Hybrid	P3 Hybrid
EV		NA <sup>1</sup>	A <sup>2</sup>	A
ICE	NA		A	NA
P2 Hybrid	NA	A		A
P3 Hybrid	A	NA	A	

#### 4. Results

In order to determine the response and operation of the proposed HBCVT, first operation in ICE mode is tested. In this simulation, it is assumed that initial speed is zero, the input torque is equal to 250 Nm (constant during simulation) and for the first 20 seconds, the overall gear ratio is selected as 4, followed by a linear gear ratio reduction to 1 for the next 15 seconds (Figure. 13). Meanwhile, corresponding BCVT ratio is shown in Figure. 13. In this condition torque and speed behavior of the OS are shown in Figure. 14. It is seen that, when time reaches to 20 second, AMT is in the first gear number and ratio of BCVT varies from 2 to 0.5. For the final 15 seconds overall gear ratio decreases linearly into 0.25 which cause a gear changing in AMT while ratio of BCVT return to the upper range, followed by a BCVT ratio reduction from 2 to 0.5 for the final 15 seconds of simulation. The torque

fluctuation in 35<sup>th</sup> second is the result of this sudden gear shifting which happens due to ICES power disconnection.

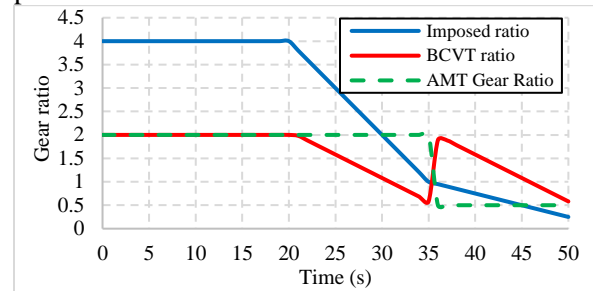

Figure. 13. Imposed overall gear ratio and corresponding BCVT ratio vs. simulation time.

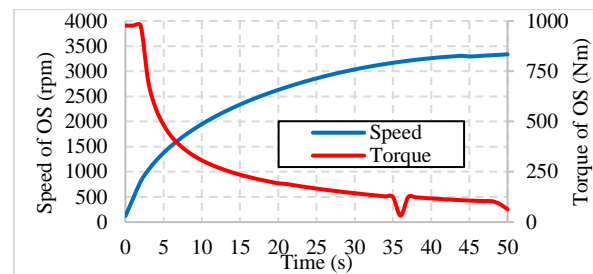

Figure. 14. Speed and applied torque at OS during acceleration.

As described in Table 3, the HBCVT must be able to perform mode changing in seven different configurations to fulfil the vehicle requirements. This mode alteration is demonstrated in the following figures. Considering transmission function in EV mode in first ten seconds and mode changing to P2 hybrid mode in next 2 seconds, Figure. 15, shows the speed and applied torque of output shaft of HBCVT. In this figure, there is another mode changing from P2 hybrid to ICE mode in 30<sup>th</sup> second. The fluctuation of imposed torque to the output shaft which is the result of imposed negative power from cause reduction of speed in each step of disruption of power from sources (i.e. ICE and/or EM/G). To see the effect of changing driving mode from ICE to P2 hybrid and then to P3 hybrid, Figure. 16 demonstrate the speed and applied torque of the output shaft in this situation. In Figure. 16, the speed is raising due to the positive overall torque. Changing driving mode from ICE to P2 hybrid occurs in 10<sup>th</sup> second and as result interrupt of input torque cause slight variation in speed. In 30<sup>th</sup> second another mode changing happen from

<sup>1</sup> NA: not applicable

<sup>2</sup> A: applicable



P2 hybrid to P3 hybrid which cause another gap in imposed torque. Please be noted during both mode changing clutch will be disengage as described before.

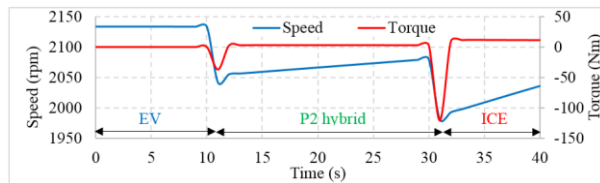

Figure. 15. Mode shifting from EV to P2 hybrid in first 20 seconds and changing from P2 hybrid to ICE mode in next 20 seconds

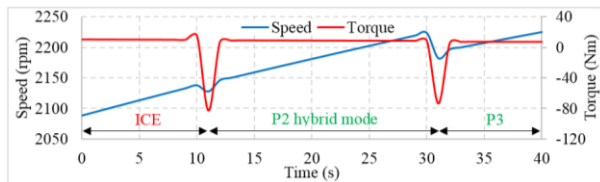

Figure. 16. switching from ICE mode to P2 hybrid mode in first 20 seconds and then changing from P2 hybrid to P3 hybrid mode in next 20 seconds

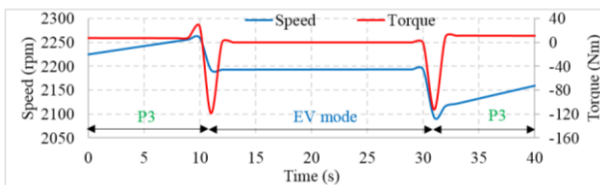

Figure. 17. Mode changing from P3 hybrid to EV in first 20 seconds and then changing from EV to P3 hybrid mode in next 20 seconds

To simulate all the mode changing in Table 3, Figure. 17 shows shifting from P3 hybrid to EV mode in 10<sup>th</sup> second and the shifting from EV to P3 hybrid mode in 30<sup>th</sup> second and interrupt of input torque cause variation in speed. It is critical to analyze each mode changing and deploy a well-tuned control strategy like torque gap filler [25] which is beyond the scope of this paper.

In Figure. 15, changing driving mode from EV to P2 cause an interruption of imputed torque to the system which results changing output speed of system. After that, by changing mode of driving from P2 to ICE mode, since engagement of ICE is only through dry clutch system, a shock to the system cause drop in speed, but by increasing the torque, speed is raising. In Figure. 16, mode changing cause interruption in torque flow twice and as result the speed has fluctuations in 10<sup>th</sup> and 30<sup>th</sup> seconds. Moreover, in Figure. 17,

since changing driving mode from P3 to EV and then to P3, deals with ICE turning off and on, larger shocks cause changing in output speed of system.

## 5. Conclusions

This research demonstrates a new type of transmission that features high torque capacity and desirable drivability by combining two technologies. A new hybrid parallel transmission and its control method are presented, which enjoy mechanism with continuously variable ratio changing, named as HBCVT. Different operational modes are introduced by detail. To demonstrate the operation of HBCVT and analyze its dynamics, by considering multi body model, simulation study has been built in various steady and transient modes. Simulation results revealed advantages of this system which are improved drivability and performance as well as elimination of most of the limitations of parallel hybrid systems, by using the BCVT as the core component. Moreover, it is proved that using a hybrid system in vehicle drivetrain always has lower fuel consumption and emission benefits.

## Reference

- [1] Shiao, Y. and L.V. Dat, *Efficiency improvement for an unthrottled SI engine at part load*. International Journal of Automotive Technology, 2012. **13**(6): p. 885-893.
- [2] Ruan, J., N. Zhang, and P. Walker. *Comparing of single reduction and CVT based transmissions on battery electric vehicle*. in *2015 IFToMM World Congress Proceedings, IFToMM 2015*. 2015.
- [3] Ryu, W. and H. Kim, *CVT ratio control with consideration of CVT system loss*. International Journal of Automotive Technology, 2008. **9**(4): p. 459-465.
- [4] Di Nicola, F., et al., *Optimization of a multiple-speed transmission for downsizing the motor of a fully electric vehicle*. SAE International Journal of Alternative Powertrains, 2012. **1**(1): p. 134-143.
- [5] Lechner, G. and H. Naunheimer, *Automotive transmissions: fundamentals, selection, design and application*. 1999: Springer Science & Business Media.
- [6] Kluger, M.A. and D.M. Long, *An overview of current automatic, manual and continuously variable transmission efficiencies and their*

- projected future improvements.* SAE transactions, 1999: p. 1-6.
- [7] Biglarian, H., et al., *A Strategic Mild Hybrid Technology for Reducing Pollution and Optimization of Fuel Sources.* International Journal of Automotive Engineering, 2014. **4**(4).
- [8] Xiang, C., et al., *Energy management of a dual-mode power-split hybrid electric vehicle based on velocity prediction and nonlinear model predictive control.* Applied energy, 2017. **189**: p. 640-653.
- [9] De Novellis, L., G. Carbone, and L. Mangialardi, *Traction and efficiency performance of the double roller full-toroidal variator: a comparison with half-and full-toroidal drives.* Journal of mechanical design, 2012. **134**(7).
- [10] Maleki Pour, E. and S. Golabi, *Design of continuously variable transmission (CVT) with metal pushing belt and variable pulleys.* International Journal of Automotive Engineering, 2014. **4**(2): 699-717.
- [11] Carbone, G., L. Mangialardi, and G. Mantriota, *A comparison of the performances of full and half toroidal traction drives.* Mechanism and Machine Theory, 2004. **39**(9): p. 921-942.
- [12] Zhang, Y., X. Zhang, and W. Tobler, *A systematic model for the analysis of contact, side slip and traction of toroidal drives.* J. Mech. Des., 2000. **122**(4): p. 523-528.
- [13] Li, C., et al., *Modeling, kinematics and traction performance of no-spin mechanism based on roller-disk type of traction drive continuously variable transmission.* Mechanism and Machine Theory, 2019. **133**: p. 278-294.
- [14] Belfiore, N. and G.D. Stefani, *Ball toroidal CVT: a feasibility study based on topology, kinematics, statics and lubrication.* International Journal of Vehicle Design, 2003. **32**(3-4): p. 304-331.
- [15] Park, N., et al., *Development of the inner spherical CVT for a motorcycle.* International Journal of Automotive Technology, 2009. **10**(3): p. 341-346.
- [16] Ghariblu, H., A. Behroozirad, and A. Madandar, *Traction and efficiency performance of ball type CVTs.* International Journal of Automotive Engineering, 2014. **4**(2): p. 738-748.

[