

Investigation of Variance of Roller Burnishing Parameters on Surface Quality by Taguchi Approach

E. Rafati*

Department of Mechanical Engineering,
Islamic Azad University Majlesi Branch, Isfahan, Iran
E-mail: eh_1358@yahoo.com

*Corresponding author

M. S. Mahdih

Department of Mechanical Engineering,
University of Tehran, Iran
E-mail: s_mahdih@ut.ac.ir

Received: 11 August 2012, Revised: 17 November 2012, Accepted: 14 January 2013

Abstract: Surface roughness of engineering parts is a very significant property that effectively influences on the wear and fatigue strength as well as bearing load capacity. There are many methods for improving surface quality of engineering parts such as grinding, lapping and honing. Roller Burnishing is one of the techniques for improving surface quality. Roller Burnishing improves surface quality by means of Cold working. It depends on many factors such as RPM of work piece, feed rate of Burnishing tool and the penetration depth of Roller burnishing tool into the work piece. At the present paper, we have tried to investigate the effective factors of Roller Burnishing and optimize them by means of Taguchi approach.

Keywords: Experiment Design, Roller Burnishing, Surface Roughness, Taguchi Approach

Reference: Rafati, E., and Mahdih, M. S., "Investigation of Variance of Roller Burnishing Parameters on Surface Quality by Taguchi Approach", Int J of Advanced Design and Manufacturing Technology, Vol. 6/ No. 3, 2013, pp. 77-81.

Biographical notes: **E. Rafati** has received his MSc in Mechanical Engineering from Islamic Azad University, Najafabad Branch, in 2008. He is currently Lecturer at the Department of Mechanical Engineering, Islamic Azad University, Majlesi Branch, Isfahan, Iran. His current research interest includes Machining and Surface Roughness. **M. S. Mahdih** has received his MSc in Mechanical Engineering from Isfahan University of Technology in 2008. He is currently a PhD student at the Department of Mechanical Engineering, Tehran University, Tehran, Iran. His current research interest includes Machining and Surface Roughness.

1 INTRODUCTION

Surface quality is a significant parameter for evaluating engineering quality of engineering parts. There is no manufactured part with absolutely smooth surface due to the small unevennesses existing at the part's surface. There are two types of surface treatments for improving the surface quality, first the chip producing machining processes like grinding, honing and lapping and the second one is the chipless processes performed by plastic deformation of surface material without removing any particle of material. In other words, the second type of processes imposes cold working on the part surface due to movement and rearrangement of surface layers. This is similar to shot peening, where the part undergoes cold work process by means of throwing small steel balls on the work piece surface.

Another process of second type is burnishing process acting by means of cold working. High pressure imposed by ultra-smooth and hard rollers of burnishing tool makes plastic deformation on the part surface leading to the improvement of surface quality. Because of the plastic deformation, the projections of the work piece surface become flat and therefore the surface roughness decreases. In addition to the surface roughness reduction, burnishing process has other advantages such as increasing the surface hardness, increasing the fatigue strength and wear resistance because of plastic deformation and also increase in bearing load capacity.

The previous research works carried out on the burnishing process are:

El-Axir has published the first papers on burnishing process in 2000 [1]. El-Axir and El-Khabeery continued their research in the field of surface integrity of burnished parts in 2001 [2]. Bouzid simulated the burnishing process by FEM software and compared his findings with experimental results in 2005, where he applied steel AISI 1042 for the experiments [3]. Lopez did extensive experiments similar to El-Axir but on super alloy Inconel 718 in 2007 [4]. Shiou et al. carried out comprehensive surveys on the effect of three processes namely burnishing, polishing and grinding on the surface quality of quenched and tempered steel work piece and compared the results in order to introduce the appropriate process in 2008 [5].

In 2008, Othmanb worked on surface quality of aluminium-2014 work piece surface treated by ball burnishing process. He succeeded to optimize the machining parameters of burnishing process [6]. Seemekeri and his colleagues performed many burnishing experiments on the steel AISI 1045 and reached valuable results in 2008 [7]. Yeldose worked on the burnishing tools, and tried to improve the burnishing parameters and the specifications of

burnishing tools in 2008. For example, he coated the rollers of the burnishing tool with titanium in order to obtain better surface quality. His research was very significant from academic and industrial aspects [8]. Korzynski presented a mathematical model for the burnishing parameters in 2009. He also carried out some surveys on the eccentric burnishing [9], [10]. In the present paper, the major machining parameters of roller burnishing process have been studied through empirical experiments. The effect of each parameter on surface integrity has been investigated and the optimum value of parameters has been obtained through implementing Taguchi approach.

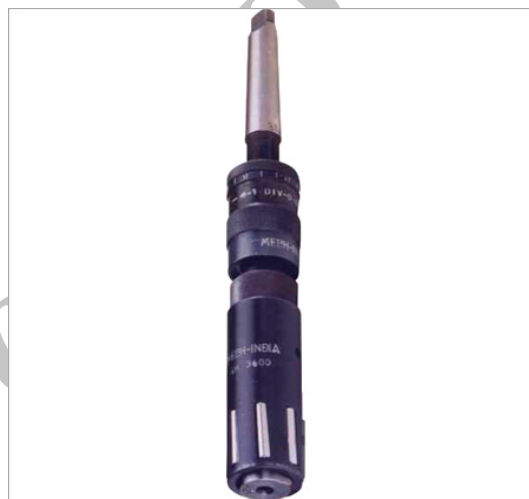

Fig. 1 Roller burnishing tool



Fig. 2 Entering the roller burnishing tool into the work piece (Performance of ECOROLL Company)

2 ROLLER BURNISHING PROCESS

Roller burnishing tool consist of some rollers and a cage for retaining rollers (Fig. 1). The hardened and carefully polished rollers revolve around the central mandrel, where the rollers impose uniform pressure on the internal surface of the work piece. The diameters of

the rollers and mandrel are the main attributes of the burnishing tool and in general, should be greater than diameter of the hole in the part, with a tight tolerance. The burnishing tool applied in this project is manufactured by MECH-INDIA ENGINEERS PVT. LTD. Figure 2 illustrates entering of the roller burnishing tool into the work piece. As mentioned above, through burnishing process, surface layers are removed and consequently, the surface roughness is reduced, hence the flatness is improved.

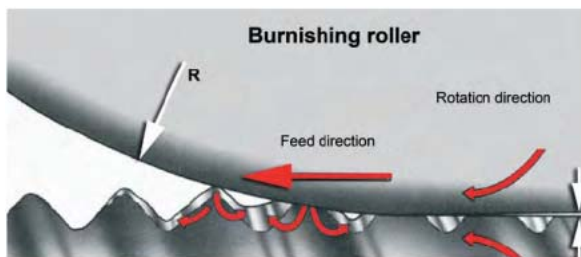
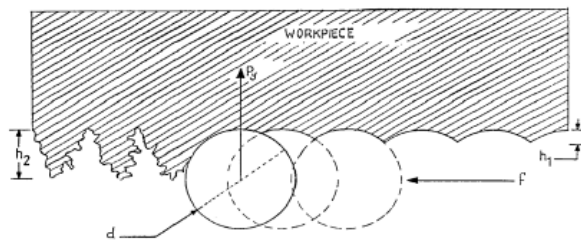

Fig. 3 Flatten the surface layer of part [11]

In figure 4 the surface of the work piece is illustrated before and after burnishing process; it is obvious that the surface quality improves and the roughness reduces to few tenths of micrometers.

The main advantages of roller burnishing process are:

- Reducing the surface roughness to 4 micro inches.
- Improving the dimensional tolerances to 0.0005 inches.
- Reducing the friction because of smoothing the contact surfaces.
- Improving corrosion and wear strength.
- Omitting the further costly operation such as honing and grinding.
- Increasing the production rate.

Specifications of the work piece

The material of the work piece utilized in this survey is Al-2014, where the work piece dimensions is illustrated in figure 5. The mechanical and the chemical specifications of this alloy are illustrated in table 1 and table 2 respectively.

Table 1 Mechanical specifications of Al-2014

Yield Strength (MPa)	186
Tensile Strength (MPa)	96
Hardness (BHN)	45
Shear Strength (MPa)	124
Tensile elastic modulus (MPa)	6.89×104
R _m (MPa)	300
R _{0.2} (MPa)	180
A%	27

Table 2 Chemical specifications of Al-2014

Element	Weight percent
Al	92.45
Si	0.50
Fe	0.7
Cu	4
Mn	1.2
Cr	0.8
Zn	0.1
Ti	0.25

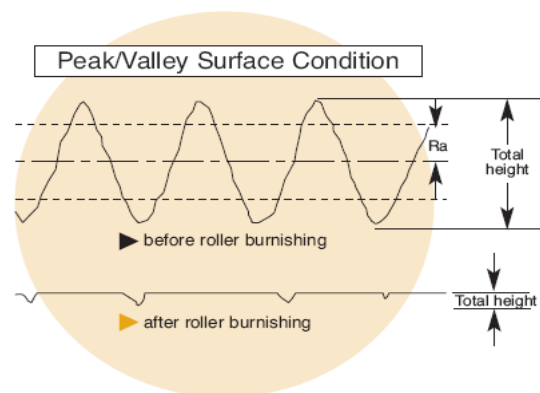
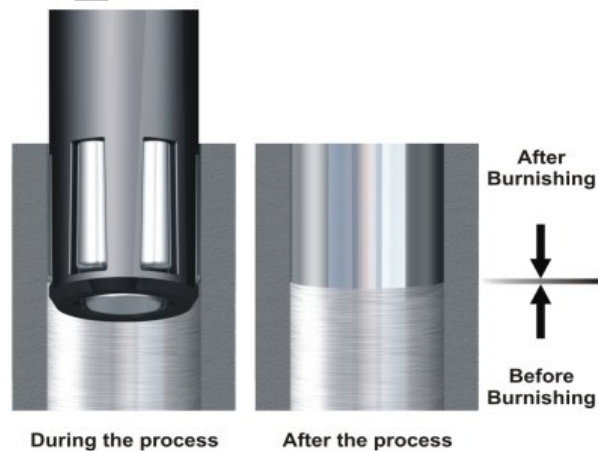

Fig. 4 Surface of the work piece before and after burnishing process (Performance of WENAROLL Company)

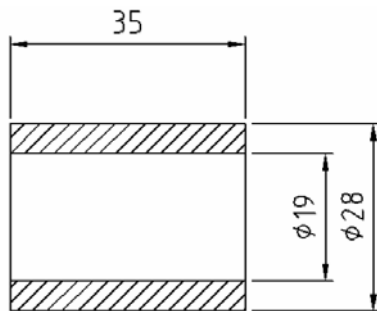

Fig. 5 Dimensions of the work piece

3 EXPERIMENT DESIGN

In conventional design of experiment methods, the output parameter is defined as a function of some input variables, each with specified range of variation. For each parameter, some values should be selected within the specified range of variation, which are generally addressed as variable's level. The pattern of conducting experiments is chosen, based on design of experiments method, which is Taguchi method in the present paper. The pattern defines the total number of experiments, each with pre-defined variable levels.

The output parameter in these experiments is roughness where it is desired to minimize the surface roughness. The parameters or variances are categorized in two types; first the parameters of the work piece before burnishing process such as pre-surface quality, dimension, material and etc and second, the parameters relating to tool and machine setting. In this paper, the first types of parameters were similar and constant for all the work pieces. The tool setting parameters are RPM of work piece, feed rate of Burnishing tool (mm/min) and the penetration depth of roller burnishing tool into the work piece (mm). Table 3 shows the coding of each factors and the quantity of them.

Table 3 Coding of factors and the quantity of them

Effective parameter	Symbol	Quality of parameters			Code of parameter		
RPM	A	45	355	710	1	2	3
Feed Rate (Mm/rev)	B	0.1	0.45	1	1	2	3
Depth of Penetration (mm)	C	0.015	0.025	0.035	1	2	3

In the present paper the standard L9 matrix of Taguchi approach is selected, hence table 4 seems to be proper for conducting the experiments. Hence the experiments are done on 9 parts and the 10th part remained intact as the testifier part. The results of the experiments are illustrated in table 5. The results are also displayed as three dimensional diagrams (Figs. 6 to 8). These

diagrams are obtained by spline interpolation in MATLAB.

Table 4 Standard L9 matrix of Taguchi approach

Parameters	A	B	C	RPM	Feed Rate	Depth of Penetration
Experiment No.						
1	1	1	1	45	0.1	0.015
2	2	2	2	355	0.45	0.025
3	3	3	3	710	1	0.035
4	3	2	1	710	0.45	0.015
5	1	3	2	45	1	0.025
6	2	1	3	355	0.1	0.035
7	2	3	1	355	1	0.015
8	3	1	2	710	0.1	0.025
9	1	2	3	45	0.45	0.035

Table 5 Results of the experiments

Experiment No.	RPM	Feed Rate	Depth of Penetration	Roughness(μm)
1	45	0.1	0.015	0.653
2	355	0.45	0.025	0.302
3	710	1	0.035	0.25
4	710	0.45	0.015	0.482
5	45	1	0.025	0.15
6	355	0.1	0.035	0.528
7	355	1	0.015	0.102
8	710	0.1	0.025	0.687
9	45	0.45	0.035	0.375
10	Testifier part			4.5

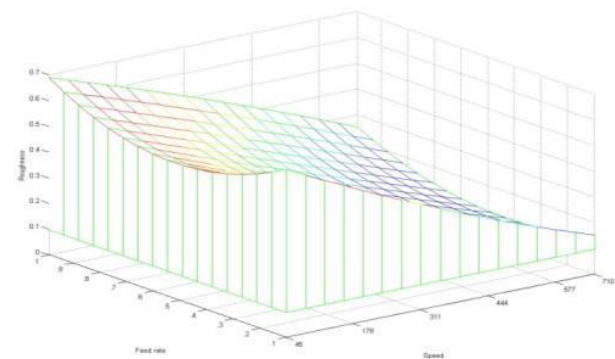

Fig. 6 Surface roughness of the parts according to RPM and feed rate

Considering these diagrams, it is concluded that the roughness of the parts reduces by increasing the rotational speed of the work piece. However lowering the feed rate has almost the same effect where the roughness nearly reduces by increasing the feed rate. Although the effect of the penetration depth of burnishing tool on the surface roughness is irregular, it

was observed that in general, greater depth of penetration leads to increased surface roughness.

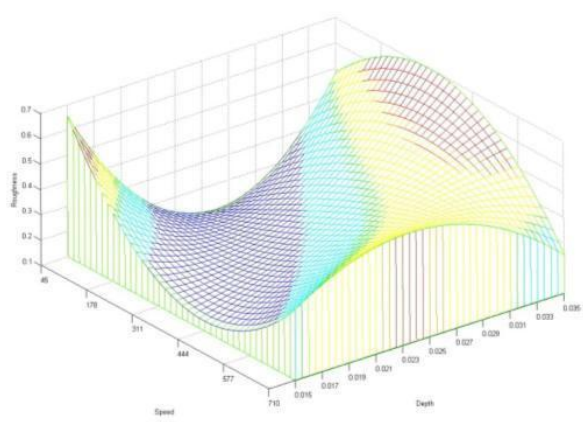

Fig. 7 Surface roughness of the parts according to RPM and depth of penetration

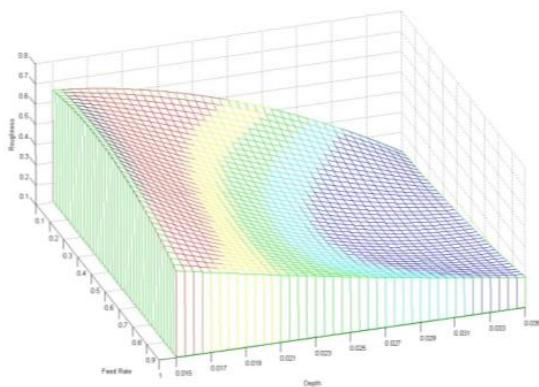

Fig. 8 Surface roughness of the parts according to depth of penetration and feed rate

4 CONCLUSION

The burnishing process is very complicated and it is influenced by many factors. Thus, investigating the parameters and their influences is a significant task in order to optimize the burnishing process. In brief, the conclusions of this work are as follows:

- 1- The experiments results revealed that rotational speed, tool's depth of penetration and feed rate are the most important factors in roller burnishing process.
- 2- Increasing the rotational speed (RPM) leads to the surface quality improvement, where the best surface quality (less surface roughness) is achieved at 710 RPM.
- 3- For improving the surface quality it is recommended to reduce the feed rate of burnishing tool, thus the

minimum feed rate is proposed (in this paper was 0.1 mm/rotation).

4- As mentioned before, the effect of penetration depth of burnishing tool is complicated; nevertheless the greater penetration depth leads to the surface quality improvement.

REFERENCES

- [1] El-Axir, M. H., "An investigation into roller burnishing", *Int. Journal of Machine Tools & Manufacture*, Vol. 40, No. 11, 2000, pp. 1603-1617.
- [2] El-Khabeery, M. M., and El-Axir, M. H., "Experimental techniques for studying the effects of milling roller-burnishing parameters on surface integrity", *Int. Journal of Machine Tools & Manufacture*, Vol. 41, No. 12, 2001, pp. 1705-1719.
- [3] Bouzid Saï, W., and Saï, K., "Finite element modeling of burnishing of AISI 1042 steel", *Springer-Verlag London Limited*, Vol. 25, 2005, pp. 460-465.
- [4] López de Lacalle, L. N. Lamikiz, A., Sánchez, J. A., and Arana, J. L., "The effect of ball burnishing on heat-treated steel and Inconel 718 milled surfaces", *Springer-Verlag London Limited*, Vol. 32, 2007, pp. 958-968.
- [5] Shiou, F. J., Hsu, C. C., "Surface finishing of hardened and tempered stainless tool steel using sequential ball grinding, ball burnishing and ball polishing processes on a machining centre", *Journal of Materials Processing Technology*, Vol. 205, 2008, pp. 249-258.
- [6] El-Axir, M. H., Othmanb, O. M., and Abodien, A. M., "Study on the inner surface finishing of aluminum alloy 2014 by ball burnishing process", *Journal of Materials Processing Technology*, Vol. 202, No. 1-3, 2008, pp. 435-442.
- [7] Seemikeri, C. Y., Brahmanekar, P. K., and Mahagaonkar, S. B., "Investigations on surface integrity of AISI 1045 using LPB tool", *Tribology International*, Vol. 41, 2008, pp. 724-734.
- [8] Yeldose, B. C., and Ramamoorthy B., "An investigation into the high performance of TiN-coated rollers in burnishing process", *Journal of Materials Processing Technology*, Vol. 207, 2008, pp. 350-355.
- [9] Korzynski, M., "A model of smoothing slide ball-burnishing and an analysis of the parameter interaction", *Journal of Materials Processing Technology*, Vol. 209, 2009, pp. 625-633.
- [10] Korzynski, M., "Relief making on bearing sleeve surface by eccentric burnishing", *Journal of Materials Processing Technology*, Vol. 209, No. 1, 2009, pp. 131-138.
- [11] Thamizhmanii, S., Saparudin, B., and Hasan, S., "A study of multi-roller burnishing on non-ferrous metals", *Journal of Achievements in Materials and Manufacturing Engineering*, Vol. 22, No. 2, 2007, pp. 7-14.