

An Experimental Investigation of the Effects of Fiber Laser Percussion Drilling: Influence of Process Parameters

M. Moradi*

Department of Mechanical Engineering,
Malayer University, Malayer, Iran

Laser Materials Processing Research Center, Malayer University, Malayer

E-mail: moradi.malayeru@gmail.com

*Corresponding author

A. R. Mohaza Pak

Department of Mechanical Engineering, Faculty of Engineering,
Malayer University, Malayer, Iran

E-mail: alirezamp1991@gmail.com

A. Khorram

Department of Mechanical Engineering,

K.N.Toosi University of Technology, Tehran, Iran

E-mail: alikhorram@ymail.com

Received: 8 July 2016, Revised: 23 October 2016, Accepted: 30 October 2016

Abstract: This study is focused on investigating the parameters of laser percussion drilling process of nickel-base super alloy Inconel 718 with thickness of 1 mm. Fiber laser with the power of 500 watts was used as the laser source. Laser pulse frequency, duty cycle, laser power, focal point position, were assumed as the laser drilling process variables. The hole geometry features, i.e. entrance hole diameter, circularity of entrance hole, and hole taper were measured. The results indicated that pulse frequency of laser has a direct influence on the entrance hole diameter. Increasing the duty cycle leads to increases in hole taper. By increasing the laser power, entrance diameter and hole taper increases.

Keywords: Fiber laser, Hole geometry features, Laser percussion drilling

Reference: Moradi, M., Mohazab Pak, A. R., and Khorram, A., “An experimental investigation of the effects of fiber Laser percussion drilling: Influence of process parameters”, Int J of Advanced Design and Manufacturing Technology, Vol. 9/ No. 4, 2016, pp. 7-12.

Biographical notes: **M. Moradi** is presently Assistant Professor of Mechanical Engineering in Malayer University, Malayer, Iran, since 2012. He has passed the research and training period as a visiting researcher in the Lulea University of Technology in Sweden (2012). He received his PhD and MSc from KNTU in 2012 and 2008, respectively and Bachelor of Mechanical Engineering from Tabriz University, Iran, in 2006. **A. R. Mohazab Pak** received his MSc from Malayer University in 2015 and Bachelor of Mechanical Engineering from Tabriz University, Iran in 2013. **A. Khorram** is a PhD graduated from K.N.Toosi University of Technology in 2015. He received his MSc from Iran University of Industries and Mines and Bachelor of Mechanical Engineering from Shahid Rajaei Teacher Training University, Iran. His research is focused on statistical and experimental analyses of laser materials processing including laser welding, laser brazing, laser cladding and the optimization of these processes.

1 INTRODUCTION

Laser drilling process has become an industrial solution for creating micro or small hole drilling. Laser drilling is one of the main laser processing methods, with a wide range of applications [1]. High velocity, efficiency, cost effectiveness, generating a larger aperture ratio, and handling a variety of materials regardless of rigidity and brittleness are some of the advantages of laser drilling in comparison to conventional drilling processes [2]. Laser percussion drilling is increasing its relevance in many industrial applications. In the aircraft industry to perform the micro-holes in nickel based alloys turbine blades for cooling, or stainless steel medical components drilling, which require small holes size and quality, laser percussion drilling could be used.

Laser percussion drilling process presents extremely high speed for high aspect ratio holes. Moreover, the quality and accuracy of the holes can be excellent if the optimal parameters are set [3]. Circular drilled holes without any taper are desired in laser drilling process [4]. Hanon et al., [4] studied the effects of 600 w pulsed Nd:YAG laser parameters, peak power, pulse duration, focal plane position, and repetition rate on the 5 mm and 10.5 mm thickness alumina ceramic plaques. They found that the crater depth increased with the number of pulses due to insufficient recoil pressure inside the cavity. Mutlu et al., [5] experimentally investigated the impact of wavelength of the Nd:YAG pulsed laser and operation pressure on the crater depth and diameter in laser drilling of 0.8 mm alumina ceramic plates. The depth and diameter of the crater increased non-linearly with laser power because of the plasma shielding effect. Yilbas [6] surveyed four materials nickel, tantalum, en 58 b, and titanium to find speed of the laser drilling using a statistical analysis.

Khan et al., [7] investigated different sizes of supersonic micro gas jets percussion drilling of 200µm thick 316L stainless steel plates using 355nm wavelength nanosecond laser. Other relevant approaches, carried out by mishra and yadava [8], include the estimation of the drilled profile considering temperature-dependent thermal and optical properties, and phase change phenomena of the sheet materials. Recently laser is widely used for materials processing. In the previous researches of the author, the effects of different process parameters on the weld- bead profiles in the laser welding process were investigated and analysed [9-12]. Statistical methods specially Response Surface Methodology (RSM) and Taguchi method were used to investigate and optimize the laser materials processing [13-14]. Since laser drilling is related to several parameters, progress of a physical model becomes difficult and therefore researchers have increased statistical models for taper [7], [15-20], HAZ

[16], [20] and circularity [15], [21], [22] to investigate parameters such as peak power of laser, width of pulse, pulse frequency, focal plane position, number of pulses, and assist gas pressure.

Purpose of the present study is to investigate the effects of fiber laser percussion drilling process parameters, power of the laser, laser pulse frequency, and focal plane position on the hole geometrical features of Ni-base super alloy Inconel 718 with thickness of 1mm. The entrance hole diameter (d_i), circularity of entrance hole (Cir_{in}), and taper of the hole were considered as the geometrical features. Figure 1 displays a schematic view of the geometrical characteristics of the hole created by laser. Performing a fiber laser as the laser source on the nickel-base super alloy inconel 718 with thickness of 1 mm is an innovation of this study over the previous researches.

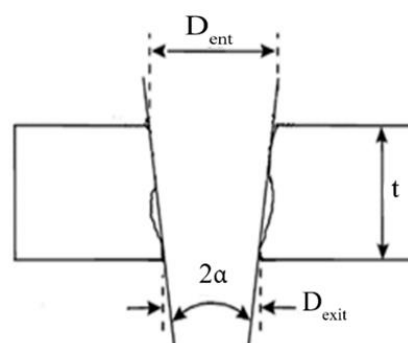

Fig. 1 The geometrical features of cross-section of the hole [15]

2 EXPERIMENTAL WORK

Nickel-base super alloy Inconel 718 with 1 mm thickness was used as the workpiece material. The chemical composition of the material is given in Table 1 that is the average of three X-ray fluorescence measurements.

Table 1 Chemical composition of nickel base super alloy Inconel 718 (Wt.%)

Ni	Fe	Cr	Nb	Mo	Ti	Al	Ta	Zr
Base	18.1	17.2	4.7	3.0	1.0	0.55	Trace	Trace

In the experiments, a fiber laser with a maximum power of 500 W with focus diameter of 80 µm was used as a laser source. The mode of laser is modulated or continuous wave; pulsed laser can be used in modulated mode. Oxygen was used as the assist gas in the experiments. Figure 2 shows the laser machine set up used in the experiments.

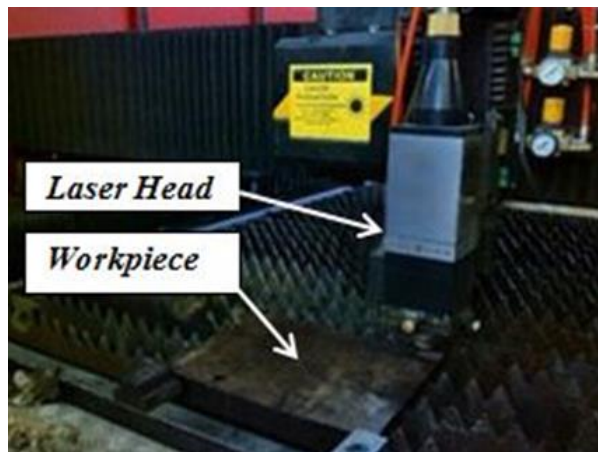

Fig. 2 Experimental set-up used for experiments

17 drilling tests were performed on sheet material by laser. Experimental tests were carried out in accordance with Table 2. As it is observed in Table 2, laser pulse frequency, duty cycle, laser power, and focal plane position (FPP) were considered as the laser drilling process variables. The oxygen assist gas pressure was fixed at 4 bars in all tests conditions. The FPP was considered zero when it was set on the material surface and above or below the surface was considered positive and negative FPP respectively [23]. Schematic diagram of the FPP is illustrated in Figure 3.

The geometry features of the entrance and exit hole diameters were measured using Axioskop 40 optical microscope at a magnification of 940× and the images were exactly measured by the Visilog software. The hole geometry features such as entrance hole, circularity of entrance hole and hole taper were considered as a function of entrance and exit holes as the responses.

The exit holes were more circular than the entrance holes therefore the circularity of exit hole was not considered [15]. Effect of the input parameters variations on hole profile geometry is shown in Figure 4. The top row of the Figure 3 shows the entrance hole diameter while the bottom row shows the exit diameter.

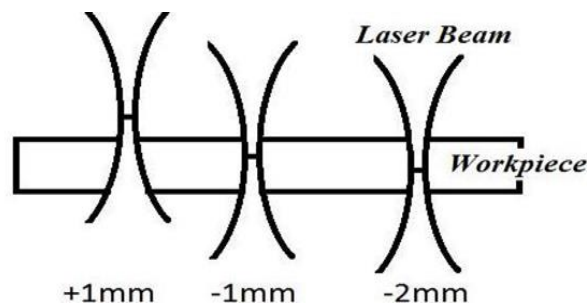

Fig. 3 Variation of focal Plane position on the work piece

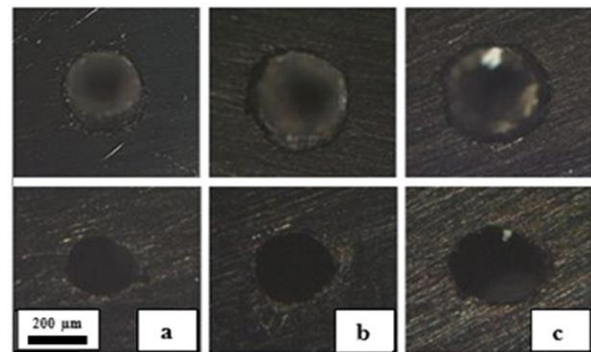

Fig. 4 The Effect of the input parameters variations on profile

Circularity of entrance and exit hole, small diameters in the entrance and exit holes determined the scope of application for variables. The extent of circularity was defined as 0-1; the nearer to 1, the higher the circularity. The diameters of the entrance and exit hole equivalent by the areas of the entrance and exit hole diameters can be achieved respectively. The taper was defined by Equation 1 [4]:

$$\text{Taper } (^\circ) = (d_{\text{entrance}} - d_{\text{exit}}) / 2t \times 180 / \pi \quad (1)$$

Where d_{entrance} is the entrance hole diameter, d_{exit} is the exit hole diameter and t is the material thickness [15]. Results of the measurements of the diameters, circularity of entrance hole and hole taper are shown in Table 2.

3 RESULTS AND DISCUSSION

The entrance hole diameter (d_i), circularity of entrance hole (cir_{in}) and hole taper were considered as the geometrical features. The effects of laser process parameters on geometrical features were investigated. The results show the relationship between the geometrical features and laser process parameters.

3.1. Effects of the laser pulse frequency

The effects of laser pulse frequency versus geometry features plots are shown in Figure 5. Higher laser pulse frequency generates larger entrance hole diameter, as shown in Figure 5 (a). The reason is accumulation of the heat input applied to the workpiece which is arised from increasing the pulse frequency. Figure 5 (b) illustrates that at lower pulse frequency, more entrance circularity could be achieved. At lower pulse frequency of the laser, the pulse-off time comes to be longer and the material has more time to be chilled and becomes nearer to solidness [15]. This can prevent ferment and any disorderliness during the process of the material removing and result in better circularity. Too much

pulses of laser after the laser beam breaks through conduct to melted material exiting from the exit hole

[4]. Figure 5 (c) illustrates that increasing the pulse frequency leads to decreasing in the hole taper.

Table 2 Laser parameters and the results of geometrical features

Samples	Laser pulse frequency (Hz)	Laser power (W)	Duty Time (%)	Focal Plane Position (mm)	D in (μm)	D out (μm)	Circularity in	Hole taper (°)
F ₁	600	500	30%	0	670	186	0.777	13.87
F ₂	500	500	30%	0	410	186	0.826	6.42
F ₃	400	500	30%	0	410	172	0.827	6.82
F ₅	300	500	30%	0	422	182	0.835	6.88
T ₁	600	500	50%	0	420	186	0.711	6.7
T ₂	600	500	70%	0	470	186	0.78	8.14
T ₃	600	500	30%	0	656	167	0.818	14.1
P ₁	600	475	30%	0	640	175	0.79	13.32
P ₂	600	450	30%	0	600	170	0.8	12.32
P ₃	600	425	30%	0	418	186	0.824	6.65
P ₄	600	400	30%	0	398	174	0.852	6.59
P ₅	600	375	30%	0	394	168	0.86	6.3
(F.P.P) ₁	600	500	30%	-0.5	356	160	0.86	5.62
(F.P.P) ₂	600	500	30%	+0.2	404	182	0.846	6.36
(F.P.P) ₃	600	500	30%	+0.5	448	182	0.819	7.62
(F.P.P) ₄	600	500	30%	+0.7	718	222	0.778	14.21
(F.P.P) ₅	600	500	30%	+1	734	220	0.678	14.73

The reason is that by increasing the pulse frequency of laser, more heat is generated on the top surface of workpiece where laser beam is focused. Therefore more material is melted and evaporated instantly and is removed from the top surface during hole formation [21].

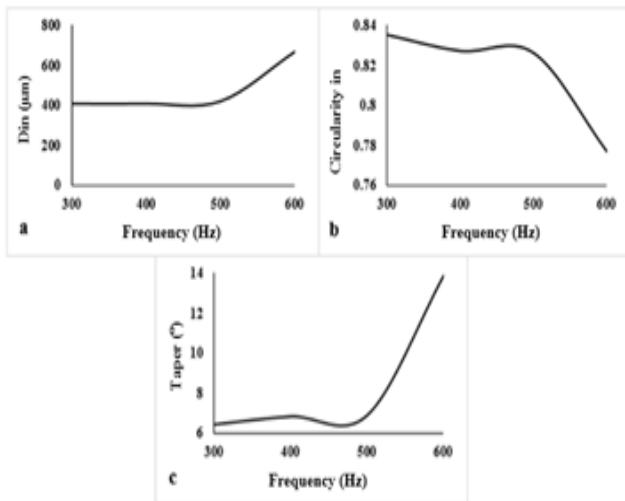

Fig. 5 The Influences of laser pulse frequency on hole geometry features

3.2. Effects of the laser power

Figure 6 shows the effects of the laser power on the geometrical process of the drilled holes. According to the Figure 6(a), increasing the laser power result in greater entrance hole. By increasing the laser power, the energy per pulse is increased [4]. Figure 6(b) illustrates that increasing the laser power produces circularity of the entrance hole. Figure 6(c) shows that the low power of laser beam generates less hole taper.

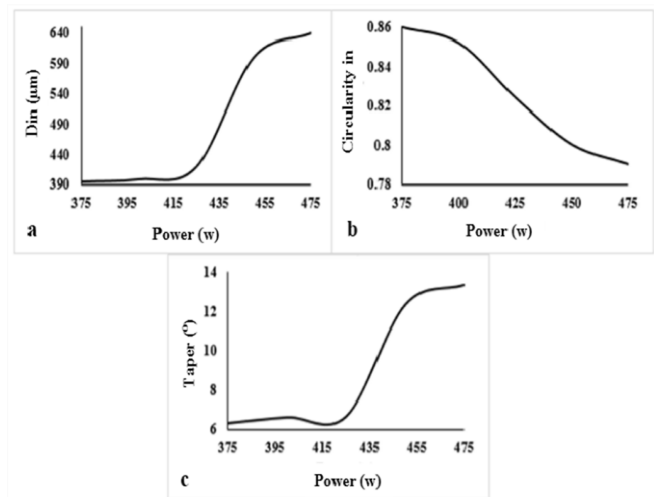

Fig. 6 The Influences of the laser power on hole geometry features

3.3. Effects of the duty cycle

Figure 7 shows the effect of duty cycle variations on the hole geometry features. According to the Figure 7 (a, b and c), by increasing the duty cycle, the diameter and circularity of the entrance hole and hole taper increase. This could be imputed to the fact that additional duty cycle increases the mean power of the laser, as well as interaction time between the material and the laser beam. As a result, the heat input applied to the workpiece increases. By increasing the heat input, melted region of the surface of the material increases in the radial direction in comparison with the thickness direction. In comparison with high duty cycle, lower duty cycle has the higher concentrated energy of laser beam that causes faster rate of penetration. Therefore less hole taper is formed [24].

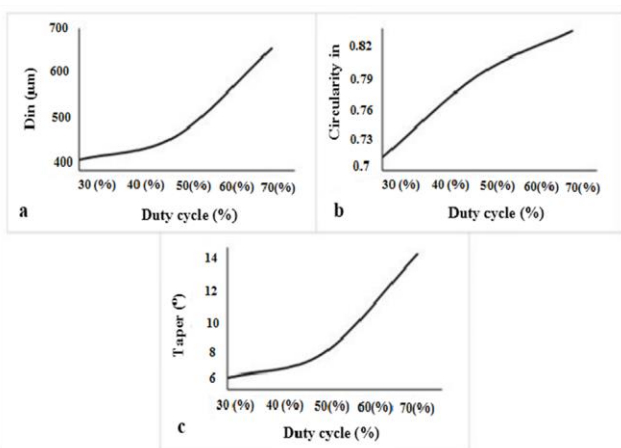

Fig. 7 The influences of duty cycle on hole geometry features

3.4. Effects of the focal plane position

Figure 8 shows the effects of variations of the focal plane position (FPP) of the laser on the hole geometry features. As shown in the Figure 8 (a) and (c), increasing the focal plane position has positive and direct effect on entrance hole diameter and hole taper. At the positive focal plane position, the laser beam spot point is formed at the top of the surface of the workpiece and covers more area of the workpiece. As a result, a larger hole diameter is created [13]. However, according to Figure 8(b), at the positive focal plane position, circularity of the entrance hole is reduced. At negative focal plane position, the laser beam spot point is formed inside or below the surface of the workpiece; therefore density of the laser power on the surface is not high enough for evaporating the surface material. As shown in Figure 3, at negative FPP and positive FPP, the laser beam at entrance hole is converging and diverging respectively. Thus greater circularity occurs at working at negative FPP.

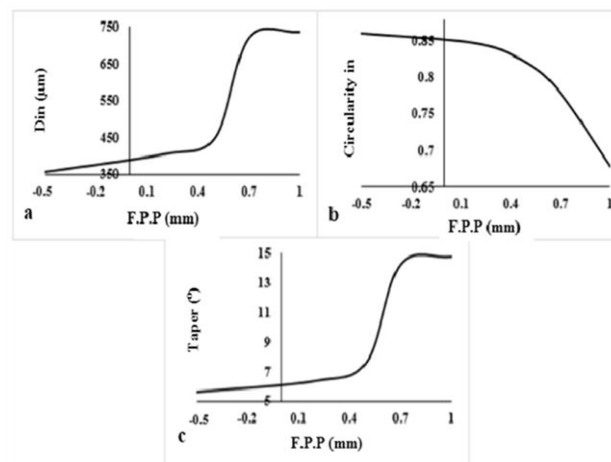

Fig. 8 The influences of focal plane position on hole geometry features

4 CONCLUSION

The present work analyses the hole geometry features of fiber laser percussion drilling process parameters on Inconel 718 with thickness of 1 mm. The following conclusions can be drawn:

- 1- The higher laser power, laser pulse frequency, duty cycle and focal plane position; the greater entrance hole diameter is produced.
- 2- Lower laser pulse frequency, laser power and focal plane position increases entrance hole circularity and higher duty cycle produce a better circularity of the entrance hole.
- 3- By decreasing laser power, laser pulse frequency, duty cycle and focal plane position, more cylindrical hole with fewer holes taper is produced.

ACKNOWLEDGMENTS

The authors would like to thank Malayer University for the financial support of this research.

REFERENCES

- [1] Zhang, Y., Li S., Chen G., and Mazumde J., "Experimental observation and simulation of keyhole dynamics during laser drilling", Optics and Laser Technology, Vol. 48, No. 11, 2013, pp. 405-414.
- [2] Moradi M., Mohazabpak, A., "Statistical modelling and optimization of laser percussion micro-drilling on

- Inconel 718 sheet using response surface methodology”, *Journal of lasers in Engineering*, 2016, article in press.
- [3] Arrizubieta, I., Lamikiz A., Martínez S., Taberero S., and Girot F., “Internal characterization and hole formation mechanism in the laser percussion drilling process”, *International Journal of Machine Tools and Manufacture*, Vol. 75, No. 2, 2013, pp. 55-62.
- [4] Hanon, M. M., Akman, E., Oztoprak B. G., and Gunes M., “Experimental and theoretical investigation of the drilling of alumina ceramic using Nd:YAG pulsed laser”, *Optics and Laser Technology*, Vol. 44. No. 2, 2012, pp. 913-922.
- [5] Mutlu, M., Kacar E., Akman E., Akkan K. S., and Demir, P., “Effects of The Laser Wavelength on Drilling Process of Ceramic Using Nd: YAG Laser”, 2009.
- [6] Yilbas, B., “Investigation into drilling speed during laser drilling of metals”, *Optics & Laser Technology*, Vol. 20, 1988, pp. 29-32.
- [7] Yilbas, B., “Investigation into drilling speed during laser drilling of metals”, *Optics and Laser Technology*, Vol. 21. No. 1, 1988. pp. 29-32.
- [8] Khan, A. H., Celotto, S., Tunna, I., and O'Neill, L., “Influence of microsupersonic gas jets on nanosecond laser percussion drilling”, *Optics and Lasers in Engineering*, Vol. 45, 2007. pp 709-718.
- [9] Mishra S., Yadava V., “Modeling and optimization of laser beam percussion drilling of thin aluminum sheet”, *Optics and Laser Technology*, Vol. 48. 2013, pp. 461-474.
- [10] Moradi M., Ghoreishi M., and Torkamany M. J., “Modeling and Optimization of Nd:YAG Laser-TIG Hybrid Welding of Stainless Steel”, *Journal of lasers in Engineering*, Vol. 23, 2014. pp. 211–230.
- [11] Moradi, M., Ghoreishi M., “Influences of Laser Welding Parameters on the Geometric Profile of Ni-Base Superalloy Rene 80 Weld-Bead”, *International Journal of advanced manufacturing Technology*, Vol. 55, No 4. 2011, pp. 205-215.
- [12] Moradi, M., Salimi, N., Ghoreishi, M., Abdollahi, H., Shamsborhan, M., Ilar, T., and Kaplan A., “Parameter dependencies in laser hybrid arc welding by design of experiments and by a mass balance”, *Journal of Laser Applications*, Vol. 26, No. 2, 2014. pp. 022004-1-9
- [13] Moradi M., Ghoreishi M., and Rahmani A., “Numerical and Experimental Study of Geometrical Dimensions on Laser-TIG Hybrid Welding of Stainless Steel 1.4418”, *Journal of Modern Processes in Manufacturing and Production* Vol. 5 No. 2, 2014, pp. 21-31.
- [14] Anawa, E., Olabi a., “Using Taguchi method to optimize welding pool of dissimilar laser-welded components”, *Optics and Laser Technology*, Vol. 40, No. 2, 2008, pp. 379-388.
- [15] Khorram, A., Ghoreishi, M., Soleymani Yazdi, M. R., and Moradi, M., “Optimization of bead geometry in co2 laser welding of ti 6al 4v using response surface methodology”, *Engineering*, Vol. 3, No. 07. 2011, pp. 708-712.
- [16] Ghoreishi, M., Low D. K. Y., and Li L., “Comparative statistical analysis of hole taper and circularity in laser percussion drilling”, *International Journal of Machine Tools and Manufacture*, Vol. 42, No. 9, 2002, pp. 985-995.
- [17] Kuar, A. S., Doloi B., and Bhattacharyya B., “Modelling and analysis of pulsed Nd:YAG laser machining characteristics during micro-drilling of zirconia (ZrO2)”, *International Journal of Machine Tools and Manufacture*, Vol. 46, 2006. pp. 1301-1310.
- [18] Li, L., et al., “Hole Taper Characterisation and Control in Laser Percussion Drilling”, *CIRP Annals - Manufacturing Technology*, Vol. 51, No. 1, 2002, p. 153-156.
- [19] Yilbas, B., “Parametric study for laser hole drilling of inconel 617 alloy”, *Lasers in Engineering*, Vol. 12, No. 1, 2002, pp. 1-16.
- [20] Yilbas, B. S., “Parametric study to improve laser hole drilling process”, *Journal of Materials Processing Technology*, Vol. 70. No. 3. 1997, pp. 264-273.
- [21] Bandyopadhyay, S., Sundar J. K. S., and Sundararajan S., “Geometrical features and metallurgical characteristics of Nd:YAG laser drilled holes in thick IN718 and Ti-6Al-4V sheets”, *Journal of Materials Processing Technology*, Vol. 127, No. 1, 2002, pp. 83-95.
- [22] Biswas, R., Kuar, A. S., Sarkar S. K., and Mitra S., “Characterization of hole circularity in pulsed Nd: YAG laser micro-drilling of TiN-Al2O3 composites”, *The International Journal of Advanced Manufacturing Technology*, Vol. 52, 2010, pp. 983-994.
- [23] Biswas, R., Kuar A. S., Sarkar S. K., and Mitra S., “parametric study of pulsed Nd:YAG laser micro-drilling of gamma-titanium aluminide”, *Optics and Laser Technology*, Vol. 42, No. 1, 2010, pp. 23-31.
- [24] Moradi M., Torkamany, N. J., Sabbaghzadeh M., and Hamed M. J., “An Investigation on the effect of pulsed Nd:YAG laser welding parameters of stainless steel 1.4418”, *Advanced Materials Research*, Vol. 383, 2012, pp. 6247-6251.
- [25] Ahn, D.-G. Jung A., “Influence of process parameters on drilling characteristics of Al 1050 sheet with thickness of 0.2 mm using pulsed Nd:YAG laser”, *Transactions of Nonferrous Metals Society of China*, Vol. 1, 2009, pp.157-163.