

Contents list available at **IJND**  
**International Journal of Nano Dimension**

Journal homepage: [www.IJND.ir](http://www.IJND.ir)

**Review article**

**An overview of scanning near-field optical microscopy in  
characterization of nano-materials**

---

**ABSTRACT**

**Z. Sobat**  
**S. Sadegh Hassani\***

*Catalysis and Nanotechnology  
Research Division, Research  
Institute of Petroleum Industry,  
P. O. Box: 1485733111, Tehran,  
Iran.*

Received 31 July 2013

Accepted 01 October 2013

Scanning Near-Field Optical Microscopy (SNOM) is a member of scanning probe microscopes (SPMs) family which enables nanostructure investigation of the surfaces on a wide range of materials. In fact, SNOM combines the SPM technology to the optical microscopy and in this way provide a powerful tool to study nano-structures with very high spatial resolution. In this paper, a qualified overview of diverse SNOM methods mostly based on aperture and aperture-less is presented.

**Keywords:** *Scanning Near-Field Optical Microscopy; Scanning probe microscope; Nano structures; Optical microscopy; Aperture less SNOM; Photon scanning tunneling microscopy; Optical fiber.*

---

**INTRODUCTION**

Optical microscopy methods based on lenses are one of the most popular microscopically method because of the ease of use, low cost, identical optical contrast mechanisms, high speed, reliability, versatility, accessibility and being non-destructive. Despite of these advantages, the optical resolution is limited to approximately half of the optical wavelength, i.e. about 300nm. In conventional optical microscopy, the diffraction limit depends on the size of spot that a light beam can be focused by normal lenses. Scanning probe microscopy (SPM) techniques can be used in imaging and metrology of surfaces using a probe. These techniques may be used to modify the sample surfaces. SPMs are excellent devices in nano-technology because of their ability to image at sub-10nm resolutions. An image of the surface is obtained by mechanically moving the probe on the specimen, line by line, and recording the probe-surface interaction as a function of position. It seemed combining the optical microscopy methods with the scanning probe techniques could create a perfect method. The resulting technique, Scanning Near-Field Optical Microscopy (SNOM), is a powerful and versatile method; there is no limitation in practical conditions and the sample under study [1-7].

---

\* Corresponding author:  
S. Sadegh Hassani  
Catalysis and nanotechnology  
research division, research  
institute of petroleum industry, P.  
O. Box: 1485733111, Tehran,  
Iran.  
Tel +98 2144739733  
Fax +98 2144739733  
Email [sadeghs@ripi.ir](mailto:sadeghs@ripi.ir)

SNOM is a microscopic method to investigate the nano-structural materials, which the limitation of far-field in conventional optical microscopes is eliminated. In this technique, the spatial resolution is greatly enhanced by modifying the size of aperture, while the resolution is not related to the light.

Many of optical phenomena with dimensions smaller than wavelength of light can act as unusual. It seems that improving the current conventional imaging techniques, could upgrade the characterizing optical methods. Uncertainty principle prevents focusing and studying very little area smaller than light wavelength. This limitation arises from interaction between electromagnetic waves and sample which diffuse the electromagnetic wave to two components:

1. Waves with low spatial frequency ( $<2/\lambda$ )
2. Damped waves with high spatial frequency ( $>2/\lambda$ )

In the classic optical methods which are related to far-field regions only the progressive waves remain, while the damped waves which are related to near-field regions decayed. In fact, the waves containing the high spatial frequency

information of object do not propagate but decay with the distance from the object. Therefore, the data of high spatial frequency components is lost at the far-field and the characteristics of intervals below the wavelength couldn't be recovered.

Near-field scanning optical microscopy operates based on detection of these damped waves in near-field domain. For this purpose, a probe in nano-meter scale is placed too close to the sample and thereby near-field is characterized directly or damped waves transformed into progressive waves which could be detected in far-field region. Figure 1 represents the different optical regions around the tip.

A nano-meter size scatter source or waveguide with sub-wavelength size aperture is responsible for this task. This method by focusing on detecting the waves at near-field zone is called the reflection mode. There is another method that exposes the sample into the high spatial frequency waves by using a sub-wavelength light source. The progressive waves which are obtained from interacting the near-field and sample could be detected in far-field region. This method is called illumination mode [5]. Figure 2 shows the details of these two modes.

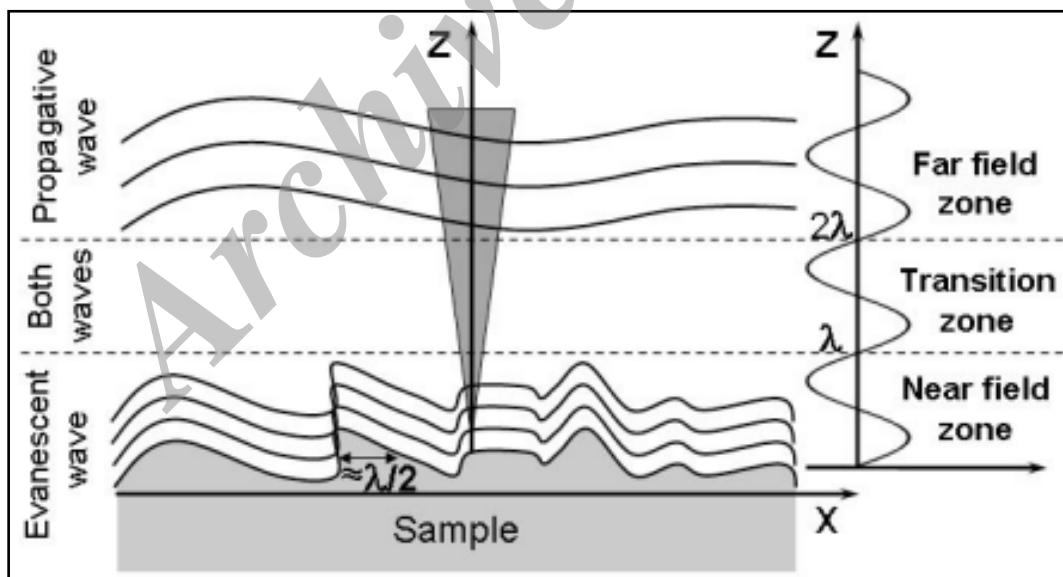

Fig. 1. Optical regions arrangement around the probe [8].

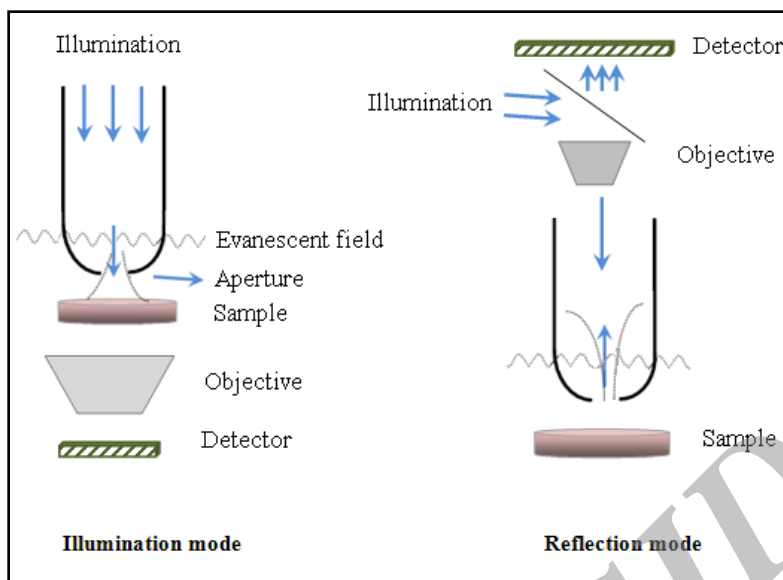

Fig. 2. The arrangement of various component of SNOM in illumination and reflection modes.

## History of SNOM evolution

Near-field scanning optical microscopy (SNOM/NSOM) was first proposed in 1928 by E.H. Synge, which at that time there was no any of that's basic elements such as laser, piezo-electric and sub-wavelength aperture [9].

To set-up this system, he applied an arc under pressure behind a thin, opaque metal film and posed a very little hole with a 100 nm diameter in it. Thereby he prepared a very small nearly planar light source. The small bright light that was created by this way could be used to illuminate very thin samples locally. The microscope took the images point-by-point and the light transmitted by the sample was detected by a high sensitive photo-detector. Of course, the illumination and moving the detector were big technical difficulties. Synge also mentioned the difficulty of making a sub-wavelength size light source that is bright enough and the difficulty in bringing a sample to the near-field zone of such a light source due to the surface roughness of usual materials as two major problems that would prevent the realization of a visible light SNOM for another 60 years. Invention of scanning probe techniques in 1980s could solve these problems.

In 1972, the first SNOM experiment was conducted by Ash and Nicholls. They used radiation in the micro-wave region and could

achieve to the resolution of  $\lambda/60$  [10]. In 1984, Pohl together with Denk and Duerig proposed an optical microscope very similar to Synge's microscope at the IBM Research Laboratory. Their key innovation to achieve high resolution was the fabrication of a Sub-wavelength optical aperture at the apex of a sharply pointed transparent probe tip that was coated with a metal. For this purpose, they pressed a metal coated quartz tip to the surface. This tinny aperture was illuminated by a laser beam and the intensity of the light transmitted through the sample was recorded. They used a feedback loop to maintain a constant gap-width of only a few nanometers, while raster scanning the sample in close proximity to the fixed probe [11]. They also pointed out drawbacks, such as control of nano-metric working distance (i.e. sample-hole distance), or weak depth of focus limiting this imaging technique to surface studies [8]. In 1986, Ferrell et al [12] and Courjon et al. [13] developed independently and respectively the Photon Scanning Tunneling Microscope and Scanning Tunneling Optical Microscope, both based on the frustrated total internal reflection. All these first studies together with progress in the probe-sample distance control (electronic feedback development) [14] and fabrication processes [15] led to the blooming of SNOM in the 90s [8]. In 1987, Betzig and et al. introduced the micropipette [16, 17] and in 1991, introduced the use of single-mode-optical

fibers as near-field optical probes which are the most popular probes today [18].

Near-field scanning optical microscopes have developed and can be operated in various conditions such as under vacuum [19, 20], in liquid or in air-liquid interface [21, 22]. A near-field imaging system is used in far-infrared by Massey [23]. Although this system may find many applications (such as in the detection of heat transport on a microscopic scale), it will not approach the resolution capabilities of SNOM and can best be viewed as a complementary imaging technique [24].

Nowadays, scientists focused on developing of cantilever type probes which has the ability of scanning the sample in contact mode and also are reproducible. Despite of development device of SNOM which are occurred recently, but operating this microscope requires the skill and proficiency of operator. This subject is a major obstacle to development of SNOM. Figure 3 shows the basic principle of SNOM with resolution which is higher than the diffraction limit. A sub-wavelength-sized light source, e.g. an aperture, is placed within the near-field zone (distance much less than the wavelength) of the sample. In this case, the area of the sample illuminated is determined by the aperture size and not by the wavelength of light. An image can then be formed by moving the sample and the light source with respect to each other [4, 25].

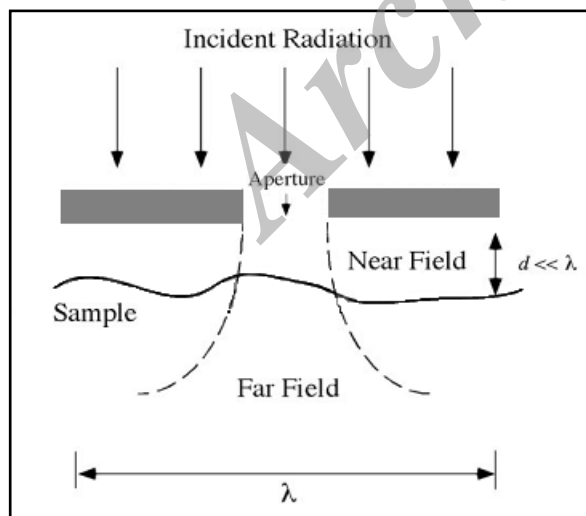

**Fig. 3.** The schematic of the basic principle of sub-wavelength resolution in near-field optics. The two critical requirements are: (1) a sub-wavelength light source (aperture in the illustration), and (2) placing the sample in the near-field zone of the light source [4, 25].

## Instrumentation of SNOM

A standard SNOM setup consists of three main units: 1) illumination unit, 2) collection and redistribution unit and 3) detection unit [4]. At the illumination unit, the light source is usually laser of suitable wavelength which is focused onto an optical fiber that has an aperture probe at its far end. Scanning near-field microscope like any other scanning methods consists of a probe and a scanning system to move the probe over the sample. In this technique, the probe must operate at the near-field, so a sample surface is scanned using a probe with sub-wavelength apex while, the distance between probe and sample is kept as a few nano-meter in the near-field region [8]. So a computer controls and synchronizes the data. The sensitive optical detector is the other complimentary part which has to be chosen according to specific applications carefully. Typically the SNOM head is composed of a conventional far-field optical microscope to position the tip on the interesting part of a sample [25]. The standard set-up for SNOM can be observed in Figure 4.

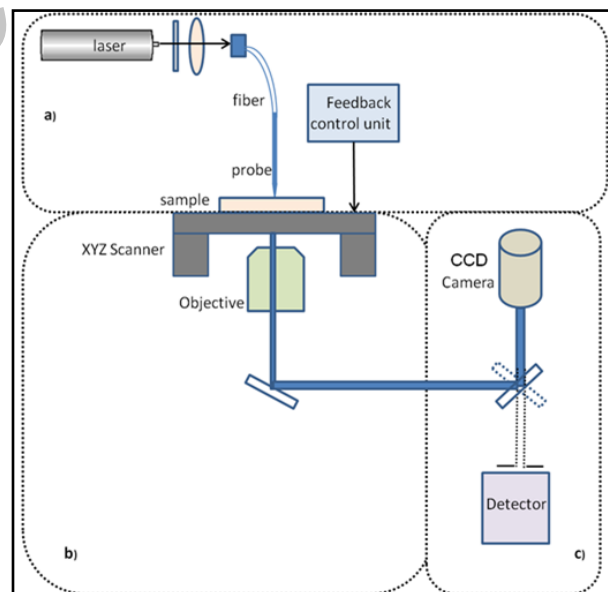

**Fig. 4.** Standard setup for SNOM consists of (a) illumination unit, (b) collection and redistribution unit and (c) detection unit.

There are two methods to localize the optical field in suitable manner which are illustrated in Figure 5. At the first stance, a small aperture is placed at the apex of tapered optical fiber coated with metal. The light is sent down and illuminates the very small area on the sample through aperture. In this module, the resolution is determined by aperture diameter which ranges from 10 to 100 nm. At the second stance, a strongly confined optical field is created by external illumination at the apex of sharpened metal or non-metal tip. This method is called aperture less or scattering SNOM. The resolution of this way ranges from 1 to 20 nm [26].

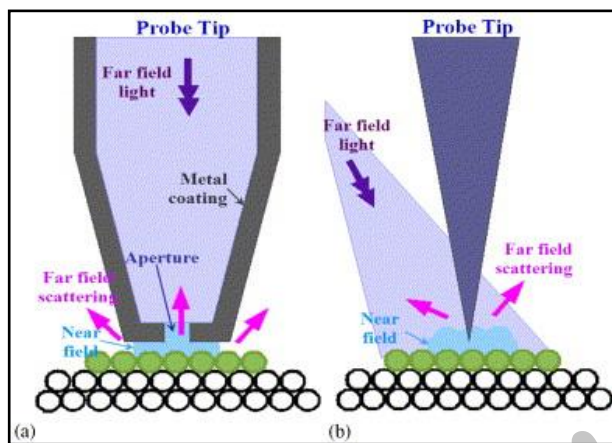

Fig. 5. the schematic illustration of (a) aperture SNOM and (b) aperture less (scattering) SNOM [27].

Illustrated light will interact with the sample. Depending on the sample and the contrast mechanism of interest, some interactions such as light absorption, phase shift and fluorescence excitation can be occurred. However, the light reflect through the sample has to be collected and detected with high accuracy. For this purpose, usually high numerical aperture microscope objectives or mirror systems are used. Both transmission and reflection modes are operated. The collected light is directed to a visual inspection port of the microscope or to a suitable detector. Filters can be inserted to remove unwanted spectral components [4].

## Probes

In scanning near-field microscopy, probes play an important role and to achieve the high resolution must have two main characteristics: very

small aperture diameter which determines the spot size and the very high intensity of light at the aperture.

In SNOM technique, probes are usually conical form with the sharp tip. There are two main methods to prepare this kind of probes:

a) Heating and pulling method: in this way, an optical fiber is locally heated by CO<sub>2</sub> laser and then pulls away from two sides. Temperature and time of heating as well as heated area are effective in the probe final form. By controlling the laser power and spot size, the aperture diameter around 50 nm and cone angle 20° can be achieved at the next step, the tapered fiber is coated by a metal. Aluminum is the most commonly used material because it has the smallest penetration depth in the visible and it forms a smooth film [4, 25, and 28]. Figure 6 demonstrate the fabrication procedure of optical fiber by heating and pull technique and you can observe the SEM image provided from a typical optical fiber in Figure 7.

b) Chemical etching: in this technique, the fiber is dipped into a HF solution covered with an over layer of an organic solvent. The end tip of the fiber is formed at the interface of HF and organic solvent at the meniscus. This technique can be used to prepare many reproducible probes at the same time. On the other hand, the taper angle which is effective parameter at light transmission can be adjusted by controlling the composition of etching solution [4, 29, 25 and 26].

For this purpose, a poly-crystalline silicon (0.5 μm) is sputtered onto the plasma enhanced chemical vapor deposition (PECVD) layer which is used as a mask for the tip etching step. The poly-silicon is patterned into small discs with a diameter of 10 μm. Then, Si<sub>3</sub>N<sub>4</sub> is isotropically etched in HF (50% at 25°C), and the etching is stopped, by the end of etching the silicon disc

In order to control the process, discs have been patterned on the Si<sub>3</sub>N<sub>4</sub> layer with diameters ranging in size from 4 to 20 μm with 2 μm step size, so they will be etched free in order of size. A thick layer of polyimide is used to mask the tip and the cantilever. The cantilever shape is etched using reactive ion etching (RIE) in CHF<sub>3</sub>/O<sub>2</sub> plasma (83% / 17%). The silicon backside is etched open using RIE in a SF<sub>6</sub>/O<sub>2</sub> plasma (75%/25%). After stripping the polyimide, the process is completed and the



individual mounting blocks with tips can be broken from the wafer.

To make aperture at the end of the tip, the evaporating technique is used. For this purpose, aluminum is evaporated at an angle of about 5 degrees out of the plane of the cantilever while rotating the tips. So, the layer thickness on the side walls of the tips is considerably larger than on the tip end. By this way, the layer thickness is minimal and so, taking optical image is promoted [1].

### Shear force feedback

Another important factor to achieve high spatial resolution is controlling the sample-tip distance during scanning. The sample-tip separation should usually be less than one third of the aperture diameter, so for typical aperture of 100nm, this distance is kept  $\leq 20\text{nm}$ . According to the samples surface are not usually smooth perfectly, the feedback mechanism must operate in a way that the

sample-tip distance is kept constant and avoid damaging the tip or sample.

At the most of SNOM techniques, a similar method to a non-contact atomic force microscopy which is called shear force feedback is used. At this mechanism, the probe is vibrated with one of its resonance frequency which is ideally at amplitudes of 1-5 nm. A suitable sensor is used to monitor the oscillation and phase of probe. While the probe is approached close to the sample, the vibrating amplitude decreases significantly because of interaction with the sample. The feedback loop can regulate sample-tip separation by sensing the tip vibration during scan. For this purpose, a feedback laser is focused onto a tip and then the scatter light at the dither frequency.

In addition, there is another non-optical method based on using the tunneling current from the SNOM tip-metal coating to the sample for feedback control, similar to STM. In this method the sample must be conductive, so this limitation restricts its performance [1, 4, 25, 26, and 29].

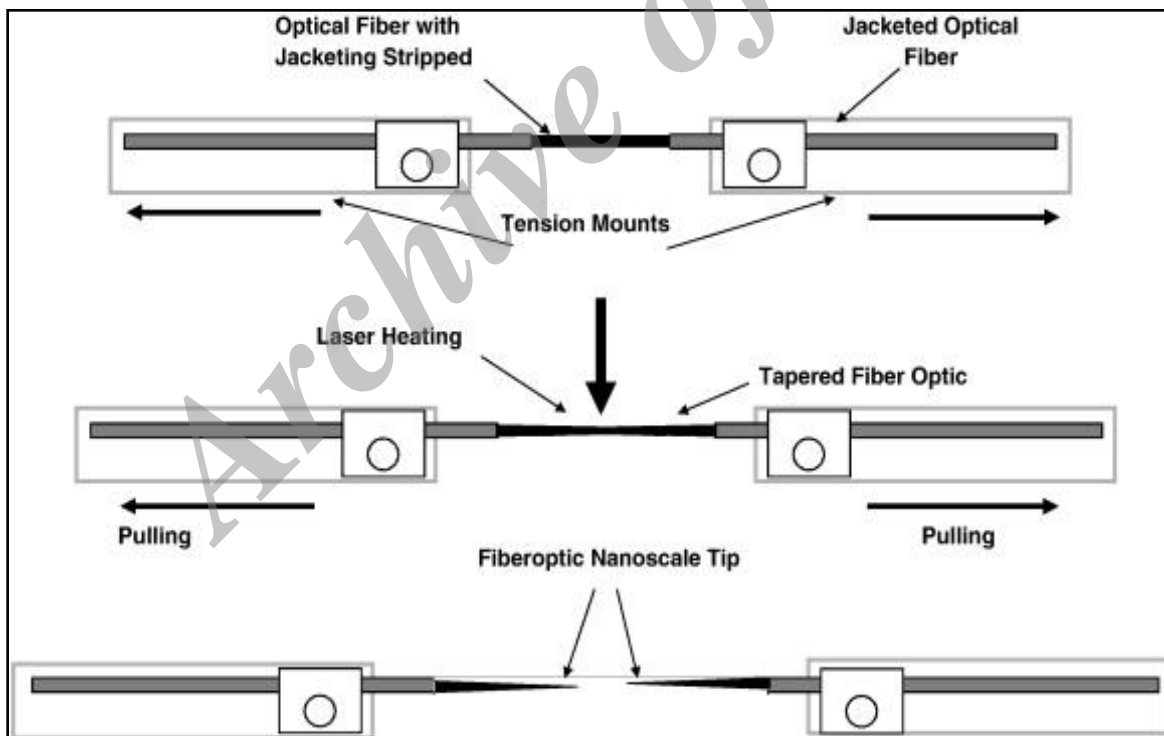

Fig. 6. Fabrication of nano-fibers using the heat and pull technique [28].

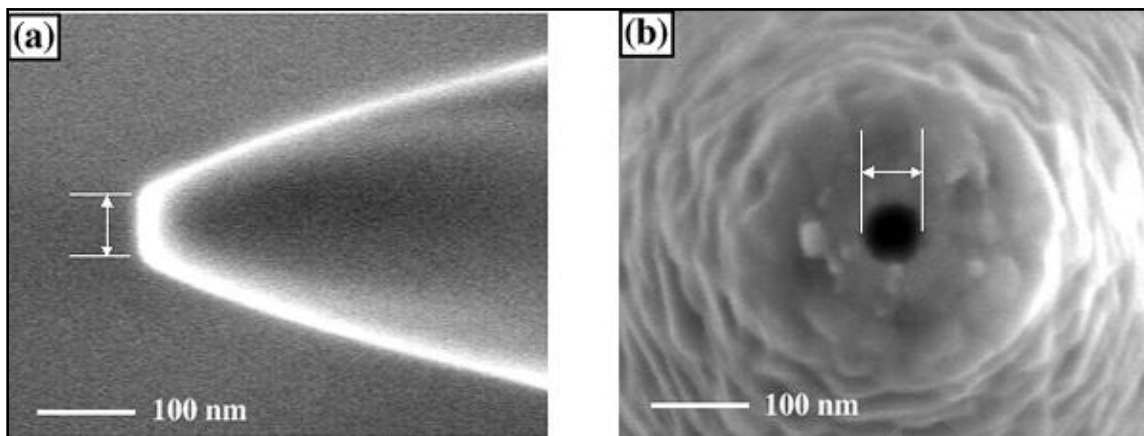

Fig. 7. SEM images of optical fiber tip. (a) side-view, (b) front view of an aluminum coated fiber [25].

### Operations modes

As mentioned previously, there are two main modes for SNOM operation, aperture SNOM and aperture less SNOM (Figure 5).

Aperture SNOM despite of many problem with aperture tips such as heating, defects due to manufacturing process, contrast, sensitivity, topology and interference is very popular and could provide very highly resolution images. Aperture modes include five operational modes which are illustrated in Figure 8.

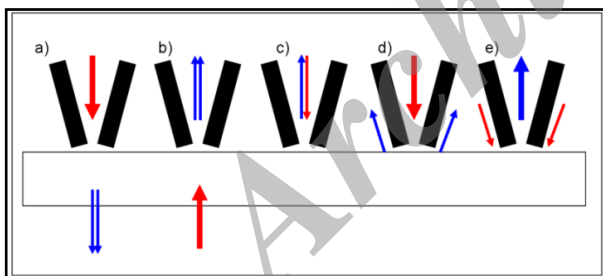

Fig. 8. the operation modes for aperture SNOM: a) illumination, b) collection, c) illumination-collection, d) reflection and e) reflection-collection [30].

The aperture less mode is another mode which needs more complicated instrument. The tips are very sharp non-metal tips. Aperture less SNOM can be applied in four modes:

a) Photon scanning tunneling microscopy (PSTM) by sharp transparent tips b) PSTM by

opaque tips c) Interfering mode and d) Radiation-reflection mode.

So according to the SNOM mode, there are some operational modes which are shown in Figure 9 and explained briefly.

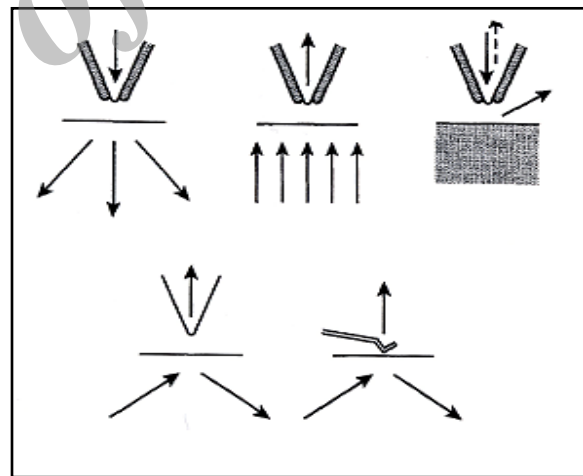

Fig. 9. The various operational modes of SNOM [31].

- Transmission mode: this mode is used for transparent samples and the light beam transmit through the aperture of probe and the sample, then is collected below the sample (Figure 9-a).

- Reflection mode: this mode is just used for opaque samples. The light beam is illuminated from dielectric probe to the sample and then the reflected beam is collected by a lens or fiber probe (usually without coating). The intensity of light is lower and depends on the tip (Figure 9-b)

- Collection mode: in this mode, the sample is illuminated by a large external source and probe collects the reflected beams. This mode is suitable for electroluminescence monitoring where the excitation of light is electrically carried out and collected by tip (Figure 9-c).

- Transmission-collection mode: in this mode, the probe illuminates the sample and also collects the reflective light (Figure 9-d).

- Photon scanning tunneling microscopy (PSTM): the operational principles of this mode are very similar to scanning tunneling microscopy (STM). In this mode, a dielectric probe (with a transparent coverless tip) neutralizes the damped wave created over the sample surface (because of total internal reflection). In fact, probe disperse the damped field and while the sample surface is scanned by the tip, photon tunneling between the sample and tip is reinforced by a photon regenerator which is connected to the other end of the fiber and finally identified by detector. Despite the simplicity of this mode, data interpretation is difficult (Figure 9-e) [30-31].

## Applications

Overall process to take image in SNOM technique as phase or amplitude contrast image is emission of light from probe to the sample, and then the light is collected and recorded at interaction zone by a sensitive photodetector. Therefore, the various contrast techniques are possible to the optical microscopy, while with the much higher resolution. In fact, by changing the polarization or intensity of light as a function of incident wavelength, enhancing the contrast of some techniques such as fluorescence, phase contrast and etc. become possible [4].

- Fluorescence imaging spectroscopy is the simplest and the most important method which provides imaging of nanostructures with high contrast. In addition, this method can identify the chemical composition and show defects, dopants and other molecular structures in semiconductors. By this technique, the biological samples with fluorescence labels can be observed with high resolution. With the advance of semi-conductors and their applications in optoelectronics, SNOM is become as an important tool to study the optical

properties of these structures. Meanwhile, this method is applied in single- quantum-dots (QDs) spectroscopy to illustrate the structure and nature of QDs [26].

However, detection of single molecules for actual biological samples is not possible, because the spatial resolution on 100nm is not sufficient. On the other hand, applying very small aperture with diameter less than 30nm is usually impossible, because leads decreasing the transmission efficiency significantly. Therefore, applying the probes which are made artfully is very important.

- Ultrafast coherent spectroscopy is a time-resolved optical spectroscopy, which is an informative method for dynamic process such as phase and energy relaxation of excitons in semiconductors. This method can be investigated the real-space diffusion, trapping and relaxation of photogenerated carriers in semiconductors. Direct study of carrier dynamics is also possible by combining the femtosecond spectroscopy with SNOM [26]

- Polarization microscopy is SNOM with polarization contrast which is suitable to investigate some material characteristics such as optical anisotropy, magneto-optical effects and electron spin dynamics. By controlling the local polarization and then detection in nano-region, the nano-optoelectronic devices and nano-recording media are progressed. Combining the polarization spectroscopy with SNOM is also applied in observing the electric field response of liquid crystal (LC) molecules. Meanwhile, depolarization SNOM makes the imaging phase change recording possible.

- Raman spectroscopy is a widely used technique to study the distribution of phase and stress as well as identifying molecules and bonds. By combining the SNOM with Raman spectroscopy, the detection of very low signals becomes available. The spatial resolution less down to 10-30nm is achievable by using metalized sharp tip in aperture less SNOM. This subject is used to improve the Raman efficiency. Hayazawa et al. have been used this point to achieve the 30nm spatial resolution with a reasonable signal intensity [26, 32].

According to enhanced above techniques by using the SNOM, study of plasmonic events, detection of single molecule, nano-lithography in



photosensitive resists, characterization of semiconductors, detection of waveguides and fibers in photonic devices, investigation of photonic band structure materials become possible.

However, it is expected that the application of this technique is extended by enhancing its resolution; this purpose can be achieved by fabrication of much better tip or improving the other different approach such as aperture less probes. Using the detectors with much more sensitivity is also effective in promoting the resolution and understanding the optical systems.

## CONCLUSIONS

In general, we can evaluate the SNOM technique as a capable tool to image the samples with high resolution that cannot be obtained easily by other techniques. Of course, improving the manufacturing of tip and using high sensitive detectors has paved the way to achieve this purpose. In fact, the new fabricated probes by modern methods have promoted the quality, reproducibility and resolution of measurements.

Furthermore, this technique can be extended to invisible light district such as infra-red and ultraviolet light which is very useful to study the biological systems. Cellular systems such as lipids, chromosomes, proteins and DNA have been investigated by this method.

SNOM can be used in optical lithography. Laser pulses emitted from the probe are able to change the topography and physical properties of photosensitive surfaces. Therefore this technique is able to write on the sample surface with high resolution that is not being achievable by other usual optical and laser systems.

## REFERENCES

[1] Theodorus Ruiters, A. G. (1997), Near-field optical microscopy: towards the molecular scale, thesis, Twente university.

[2] Heinzelmann, H., Huser, Lacoste, T., Guntherodt, H.-J., Pohl, D. W., Novotny, L., Martin, O. J. F., Hafner, Ch. V., Baggenstos, H., Wild, U. P. & Renn, A. (1995), Scanning

near-field optical microscopy in Basel, *Opt. Engine.* 34(8): 2441-5.

- [3] Dunn, R. C. (1999), Near-field scanning optical microscopy, *Chem.Rev.* 99(10): 2891-2928.
- [4] Visic, B. (2010), Near-field scanning optical microscopy (SNOM/NSOM), seminar for post graduate students.
- [5] Kaupp, G. (2006), Atomic force microscopy, scanning near-field optical microscopy and nano-scratching, application to rough and natural surfaces, springer Book.
- [6] Sadegh Hassani, S., Sobat, Z., Aghabozorg, H.R. (2008), Nanometer-scale patterning on PMMA resist by force microscopy lithography, Iran. *Journal of Chemical. Chem.Engine.* 27(4): 29-34.
- [7] Sadegh Hassani, S., Sobat, Z. (2011), Studying of various nanolithography methods by using Scanning Probe Microscope, *Int.J. Nano Dimens.*1(3): 159-175.
- [8] Lereu, A. L., Passian, A. & Dumas, Ph. (2012), Near field optical microscopy: a brief review, *Inter.J.Nanotech.* 9(3-7): 488-501.
- [9] Syngé, E.A. (1928), A suggested method for extending microscopic resolution into the ultra-microscopic region *Philosophical Magazine* 6: 356-362.
- [10] Ash, E.A. & Nicholls, G. (1972), Super-resolution Aperture Scanning Microscope, *Nature.* 237: 510-512.
- [11] Pohl, D.W., Denk, W. & Lanz, M. (1984), Optical stethoscopy: image recording with resolution  $\lambda/20$ , *Appl.Phys.Lett.*44 (7): 651-653.
- [12] Reddick, R. C., Warmack, R. J., & Ferrell, T. L., (1989), New form of scanning optical microscopy, *Phys.Rev.B.*39: 767-770.
- [13] Vigoureux, J., Girard, M.C. & Courjon, D., (1989), General principles of scanning tunnelling optical microscopy, *Optical Letter* 14: 1039-1041.
- [14] Betzig, E., Finn, P. L. & Weiner, J. S., (1992), Combined shear force and near-field scanning optical microscopy, *Appl. Phys. Lett.* 60: 2484-2486.

- [15] Puygranier, B. A. F., Dawson, P. (2000), Chemical etching of optical fibre tips – experiment and model, *Ultramic.* 85: 235-248.
- [16] Betzig, E., Isaacson, M. & Lewis, A. (1987), Collection mode near field scanning optical microscopy, *Appl. Phys. Lett.* 51 (25): 2088-2091.
- [17] Lieberman, K., Harush, S., Lewis, A. & Kopelman, R., (1990), A light source smaller than the optical wavelength, *Science* 247: 59-61.
- [18] Betzig, E., Trautman, J. K., Harris, T. D., Weiner, J. S. & Kostelak, R.L. (1991), breaking the diffraction barrier: optical microscopy with nanometric resolution, *Science*.251: 1468-1470.
- [19] Grober, R. D., Harris, T. D., Trautman, J. K. & Betzig, E. (1994), Design and implementation of a low temperature near-field scanning optical microscope, *Rev. Sci. Instrum.* 65 (3): 626-631.
- [20] Toda, Y., Kouroggi, M., Ohtsu, M., Nagamune, Y. & Arakawa, Y. (1996), Spatially and spectrally resolved imaging of GaAs quantum dot structures using near-field optical technique, *Appl. Phys. Lett.* 69 (6): 827-829.
- [21] Moyer, P. J. & Kämmer, S. B., (1996), High resolution imaging using near-field scanning optical microscopy and shear force feedback in water, *Appl. Phys. Lett.* 68 (24): 3380-3382.
- [22] Kramer, A., Hartmann, T., Stadler, S. M. & Guckenberger, R. (1995), An optical tip-sample distance control for a scanning near-field optical microscope. *Ultramicros.* 61 (1-4): 191-195.
- [23] Massey, G. A., Davis, J. A., Katnik, S. M. & Omon, E. (1985), Sub-wavelength resolution far-infrared microscopy. *Appl. Opt.* 29:1498-1501.
- [24] Betzig, E., Lewis, A., Harootunian, A., Isaacson, M. & Kratschmer, E., (1986), Near-Field Scanning Optical Microscopy (NSOM) Development and Biophysical Applications, *Imag. Tech.* 49: 269-279.
- [25] Hsu, J. W. P., (2001), near-field scanning optical microscopy studies of electronic and photonic materials and devices, *Mater. Sci. Eng.* 33: 1-50.
- [26] Saiki, T. & Narita, Y., (2002), Nano-optical imaging spectroscopy: recent advances in near-field scanning optical microscopy, *JSAP international.* 5: 22-29.
- [27] Tseng, A. A., (2007), Recent development in nanofabrication using scanning near-field optical microscope lithography, *Opt. Laser Tech.* 39(3): 514-526.
- [28] Vo-Dinh, T., (2008), nano-sensing at the single cell level, *Spectrochim. Acta part B: Atomic Spec.* 63(2): 95-103.
- [29] Hecht, B., Sick, B., Wild, U. P., Deckert, V., Zenobi, R., Martin, O. J. F. & Pohl, D. W., (2000), Scanning near-field optical microscopy with aperture probes: Fundamentals and applications, *J. Chem. Phys.* 112(18): 7761-7774.
- [30] Introduction to NSOM (2007). The Optics Laboratory, North Carolina State University.
- [31] Kaupp, G. (2006), Atomic Force Microscopy, Scanning Nearfield Optical Microscopy and Nanoscratching: Application to Rough and Natural Surfaces. Heidelberg: Springer. ISBN 3-540-28405-2.
- [32] Hayazawa, N., Inouye, Y., Sekkat, Z. & Kawata, S. (2001), Near-field Raman scattering enhanced by a metalized tip, *Chem. Phys. Lett.* 335: 369 -374.

Cite this article as: Z. Sobat, S.Sadegh Hasani: An overview of scanning near-field optical microscopy in characterization of nano-materials.

*Int. J. Nano Dimens.* 5(3): 203-212, Summer 2014