



Investigating the Effect of Accordion thin Walled Dampers on Reducing the Response of Frames Subjected to blast Loading

A. MirzaGoltabar Roshan^{1*}, A. Naseri¹, J. Nasiri larimi²

¹ Department of Civil Engineering, Noshirvani University of Technology, Babol, Iran

² Department of Civil Engineering, Islamic Azad University Kermanshah Branch, Kermanshah, Iran

Review History:

Received: 14 April 2015

Revised: 14 November 2016

Accepted: 30 October 2016

Available Online: 23 November

2016

Keywords:

Accordion Thin Walled Damper

Blast Loading

Dynamics Non-Liner Analyses

Blast Response

Steel Structures

ABSTRACT: Blast can cause progressive damage or complete damage in structures. Designing the structures for blast is so expensive and infeasible; hence, it is better to use the dampers for increasing the structure explosive resistance. The purpose of this research is to evaluate the behavior of steel frames equipped with steel accordion dampers under blast loading. Two types of frames, one with damper and one without that, have been studied to evaluate the effect of damper. The studied steel frames have been considered as single span with different heights (1 and 4 stories) impacted by two types of blast load with different values. For this purpose, non-linear dynamic analysis on different frames was conducted using ABAQUS software. The study showed that utilizing thin-wall accordion dampers remarkably improves the overall displacement of the frame, especially during intense blasts. The maximum reduction in displacement of 1-story frame for the top of column at the side close to blast under explosive load of 36 kg/cm² is about 98% and the reduction is 21% for the middle of this column. For the four-story frame, the most displacement reduction about 64% was obtained at the fourth story level and the reduction reaches 55% at the third story.

1- Introduction

Nowadays, with increase in terrorist attacks, the risk of explosive loading on structures has been increased, which necessitates analyzing and designing buildings against blast conditions. In recent decades, using seismic isolation systems, passive energy dissipation tools and active/semi-active control systems has been developed rapidly. Among them are inactive dampers, which consist of both velocity-related tools (such as viscous or viscoelastic dampers) and displacement-related tools (such as frictional or metal dampers). Metal dampers are of hysteretic type and dissipate energy through yielding at inelastic cyclic deformation, which leads to damage concentration in dampers and consequent reduction in the dynamic response of the structure.

Several researchers have been working on the effect of blast loads on the behavior of various structures. Ngo et al. [1] investigated the effect of blast on structures and recommended different approaches for evaluation of explosive loadings. Langdon et al. [2] used ABAQUS software for modeling the response of plates to explosive loadings. Chen et al. [3] utilized hybrid elements for analysis against blast and fire conditions. Krauthammer [4] carried out a series of studies on the overall behavior of connections in steel and reinforced concrete structures under blast loading. In the field of inactive

damper, Motamedi et al. [5] used accordion thin-walled tubes for exciting buckling pattern and increasing energy absorption. They recommended that this damper is capable of bearing large deformations through accordion buckling mode.

In the following study, a one-bay steel frame with one and four story is modeled in finite element software ABAQUS, in two cases of with damper and without that, and analyzed with non-linear dynamic methods under the effect of two different blast loadings. Finally, the results are compared with each other.

2- Verification of the Finite Element model

In this paper, an experimental specimen introduced in Reference [6] has been used for verification. Finite element model of the specimen is shown in Figure 1, in which all of the frame members are modeled using shell elements with S4R meshes to account more accurately the non-linear effects caused by shear and explicit procedure is used for dynamic analysis. Also, beam to column connections, as well as column end connection are assumed rigid. Similar to the experimental specimen, A304 type steel with yield and ultimate stresses of respectively 2100 and 5000 kg/cm² and ultimate strain of 0.6 is used in the numerical analysis.

Corresponding author, E-mail: ar-goltabar@nit.ac.ir

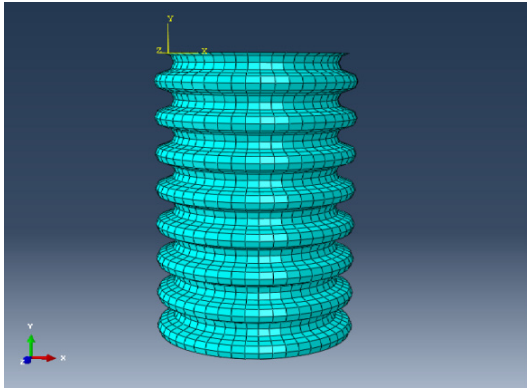

Figure 1. Finite element model of the specimen

Loading is also applied in a sinusoidal form with variable amplitude from a minimum of ± 10 mm up to a maximum of ± 35 mm. The Force-Displacement curve of the numerical model is shown in Figure 2. By comparing with that obtained from experiment, a good agreement can be observed, although we can improve analytical results by applying some modifications in the finite element model.

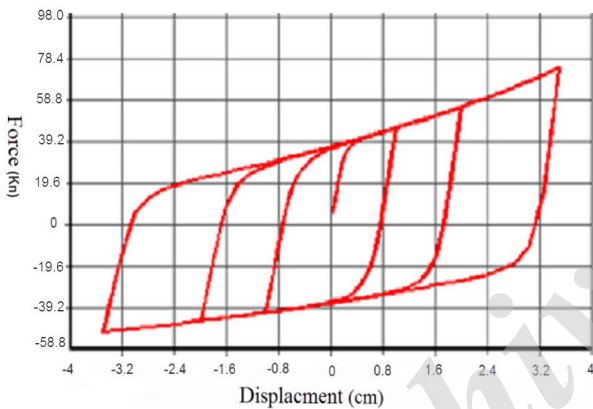

Figure 2. Hysteresis curve of numerical model

3- Analysis and discussion on results

At the first stage and for investigating the effect of accordion thin-walled damper on blast response of frames, one-story cases with 3 m height and 4 m width and beam and column sections of, respectively, Box $10 \times 10 \times 0.5$ and IPE140 are modeled in the software. For dynamic analysis, density of 7850×10^{-6} kg/cm³, Poisson's ratio of 0.3, young modulus of 2.1×10^6 kg/cm² and yield stress of 3000 kg/cm² are used for steel.

In the second stage, four story frames with heights and widths similar to one story frame and with column of Box $30 \times 30 \times 1.6$ section for the first two stories and Box $24 \times 24 \times 1.42$ for top two stories are used in the numerical model. Figure 3 shows a view of the four story model in both cases of using damper and without that. By completing the numerical models, we can now analyze them to find out the effects of damper on the behavior of the frame. Figure 4 shows von-mises stress contour of a single (without damper) one-story frame in the deformed shape against a blast with intensity of 36 kg/cm². Figure 4 indicates that column base at the blast side has the highest value of stress and middle of that column has largest plastic deformations.

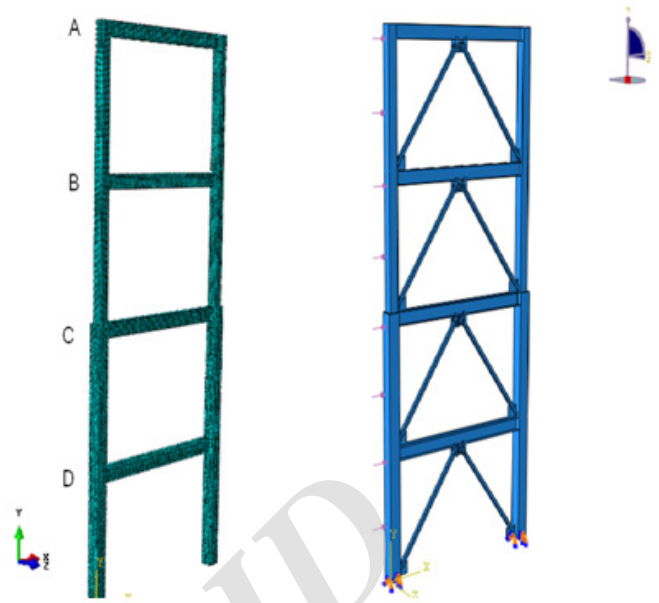

Figure 3. View of four-story frames with and without dampers and braces

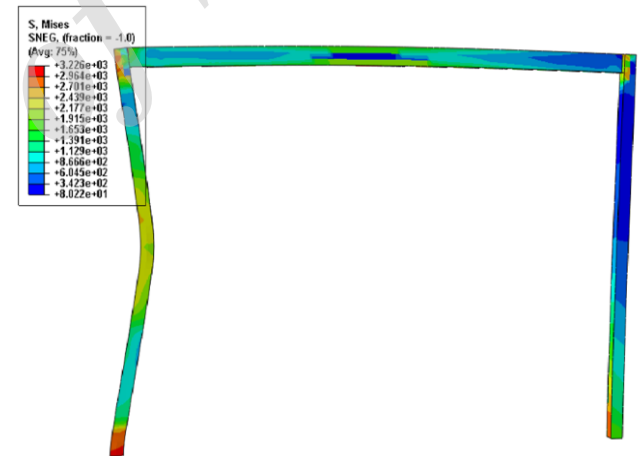

Figure 4. Von-mises stress contour for one story single frame under a blast with intensity of 36 kg/cm²

Figures 5 and 6 also show the time history of column top displacement at joints A (top level) and B (third story levels) respectively located on the blast side, from which a maximum displacement of 44.16 cm is obtained. The analysis shows a maximum displacement of 67.16 cm at the middle of that column. For a frame with damper, von-mises stress distribution is shown in Figure 7. This figure obviously highlights the reduction in the response of the frame when damper is used. However, such a reduction has not been occurred for the displacement in the middle of the column, as analysis demonstrates.

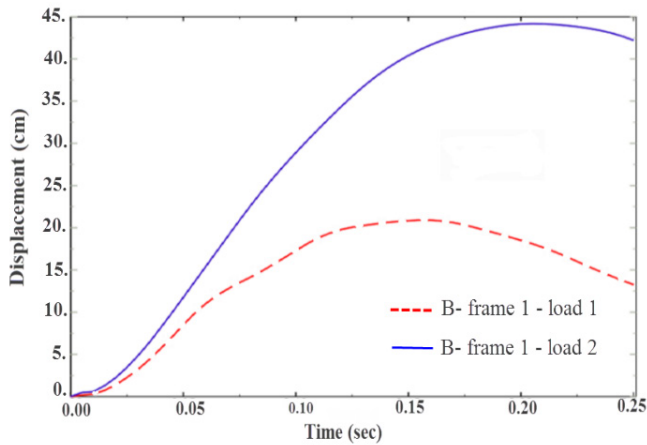

Figure 5. Time history for the displacement of joint A in a single frame under a blast with intensity of 36 kg/cm²

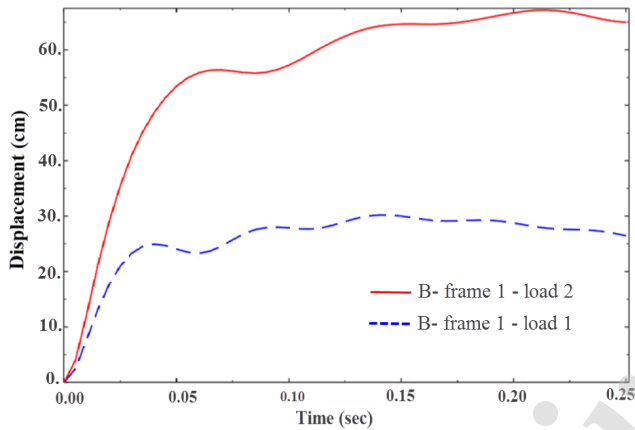

Figure 6. Time history for the displacement of joint B in a single frame under a blast with intensity of 36 kg/cm²

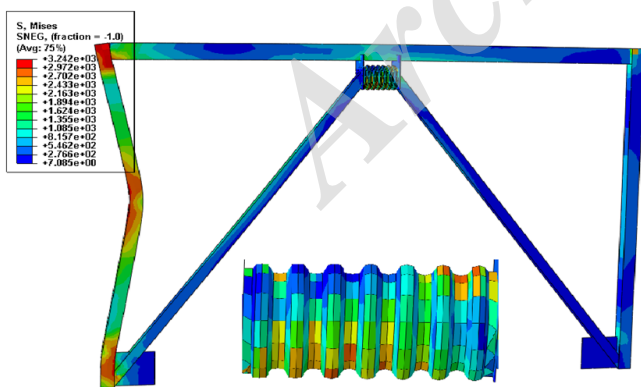

Figure 7. Von-mises stress contour for a frame with damper

For four-story frames, von-mises stress contours of a single frame and of a frame with damper are shown in Figure 8, which again high values of stress at beam to column connections at the blast side is observable. Furthermore, time histories for the displacement of these two numerical frames

are shown in Figures 9 and 10 for joints A and B, respectively. From these figures, it is obvious that the top displacement of the frame at the blast side is reduced, although this reduction is weaker compared to one-story models.

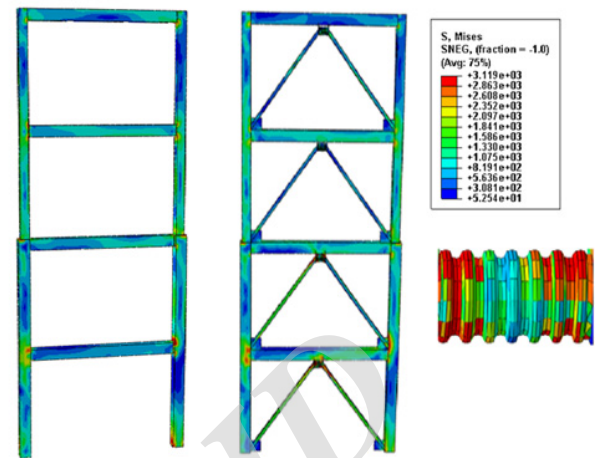

Figure 8. Von-mises stress contour for one story single frame under a blast with intensity of 36 kg/cm²

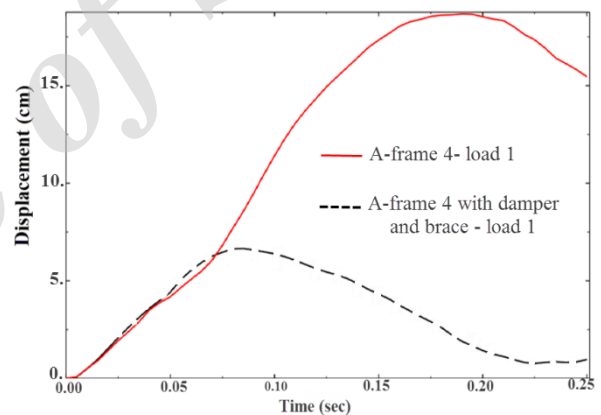

Figure 9. Time history of joint A for a four-story frame and two cases of with and without damper (blast 36 kg/cm²)

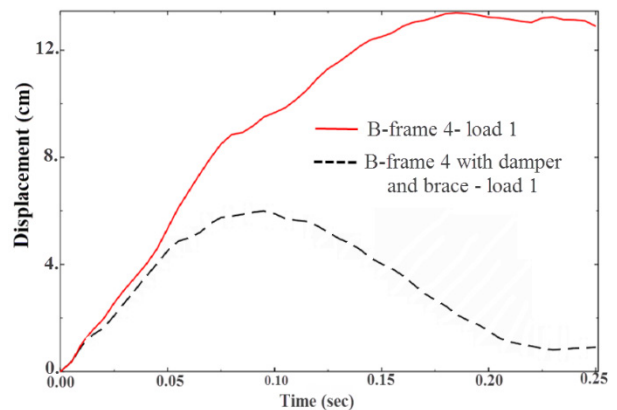

Figure 10. Time history of joint B for a four-story frame and two cases of with and without damper (blast 36 kg/cm²)

4- Conclusions

In this paper, the effect of accordion thin-walled dampers on the response of frames to blast loading has been studied. For this purpose, frames with one and four stories were modeled, in both cases of having damper and without that (single). The following results can be concluded:

1. Larger deformation is produced on the middle of the column, compared to the top, on the blast side, which can be attributed to significant local plastic deformation that occurs in highly intensive blasts.
2. Using damper in both one and four story frames would totally reduce the frame response. However, this reduction is more severe in one-story frame than four-story one.
3. Using damper and brace together would be more effective in reducing the frame response under blast loading, compared to a single frame.

References

- [1] Ngo, T.; Mendis, P.; Gupta, A. and Ramsay, J.; "Blast Loading and Blast Effects on Structures- An Overview". *Electronic Journal of Structural Engineering*, 2007.
- [2] Langdon, GS; Chung Kim Yuen, S; Nurick, GN; "Experimental and numerical studies on the response of quadrangular stiffened plates. Part II: localised blast loading", *International Journal of Impact Engineering*, Volume 31, Issue 1, pp 85-111, 2005.
- [3] Chen, H.; and Liew, J.Y.R.; "Explosion and fire analysis of steel frames using mixed element approach", *J. Eng. Mech.*, vol.6, pp 606-616., 2005.
- [4] Krauthammer, T; "Blast-resistant structural concrete and steel connections", *International Journal of Impact Engineering* 22, pp. 887-910, 1999.
- [5] Motamedi, M. and Nateghi-A,F; "Using Accordion thin-walled tubes as a Hysteretic metallic damper", 13th World Conference on Earthquake Engineering, Vancouver, Canada, Paper No.2264. August 2004.
- [6] Izadi Zamanabadi, E. Nateghi-A, F., Motamedi, M. "Comparing behavior indexes of hollow and filled with polymeric foams accordion metal dampers under cyclic axial loading", *Modares Civil Engineering journal*, Vol.2, pp 1-16, 2010 [In Persian].

Please cite this article using:

A. MirzaGoltabar Roshan, A. Naseri, J. Nasiri larimi, Investigating the Effect of Accordion thin Walled Dampers on Reducing the Response of Frames Subjected to blast Loading. *Amirkabir J. Civil Eng.*, 49(4) (2018) 707-722.
DOI: 10.22060/ceej.2016.855

