

Forecasting PMLSM Direct Thrust Control Based on Neural Network by Considering Motors Dynamic Behavior and Speed Effects

Ghazanfar Shahgholian¹, Adel Deris Zadeh²

- 1- Assistant Professor, Faculty of Electrical Engineering, Islamic Azad University Najafabad Branch, Isfahan, Iran
Email: shahgholian@iaun.ac.ir
- 2- Graduate student, Department of Electrical Engineering, Islamic Azad University Najafabad Branch, Isfahan, Iran
Email: adel_deriszadeh@iaun.ac.ir

Received: May 2010

Revised: November 2010

Accepted: December 2010

ABSTRACT:

The direct force thrust control (DTFC) is linear type of the direct torque control (DTC) method. The advantages of DTFC method are structure simplicity, low dependency to motor parameters and no requirement to coordination transformations. In this paper this method is modified in order to eliminate the defects that include the switching frequency and exciting large ripples of force and flux. In previous works, the structure simplicity of DTC, rare calculations to reduce the force ripples and fixing switching frequency are disaffirmed. With regards to keeping DTC advantages, a new method is presented in this paper to eliminate the defects by the aid of neural network. Also, the precise non-linear behavior of PMLSM motor in DTC has been considered by using space vector modulation. Finally, the simulation results concluded by the submitted intelligent DTC-SVM method are more satisfactory than other methods.

KEYWORDS: Permanent magnet linear synchronous motor, direct force thrust control, neural network, space vector modulation, non-linear friction model.

1. INTRODUCTION

In recent years there has been a significant development permanent magnet motor of various kinds. Permanent magnet synchronous (PMSM) drives become very popular in many industrial applications [1, 2]. Linear motion in linear motors is directly created by electromagnetic force. Hence, reducing electromagnetic force ripples is necessary for a drive execution with appropriate performance. One of the main types of linear motors is permanent magnet Linear Synchronous Motors (PMLSM). The rotor field, in these motors, is created by permanent magnets. These motors are used for different cases that need precise motion control. Industrial automation systems are one of the main fields in using such motors that include utilization of machine tools, welding robots, engraving systems by laser, industrial laser cutting systems and industrial robots. At present, direct torque control (DTC) system is considered a more effective and useful method for controlling rotary motors with alternative current, as compared with other system. This method is also expended for linear motor drives and is called direct force thrust control (DTFC) or (DTC) [3-7]. A modified direct torque control scheme for interior PMSM

based on the compensation of the error flux linkage vector by means of space vector modulation is investigated in [8], which features in very low flux and torque ripple and almost fixed switching frequency. The PMLSM direct thrust the classical control systems using space vector modulation (SVM) and sliding mode variable-structure are analyzed and compared in [9]. That show the system using sliding mode variable structure controller is more robust to the mover flux estimated angle error caused by the change of the mover resistance. A methodology for designing and implementing position control for PMLSM systems is presented in [10], which utilized both a function-based sliding-mode control (SMC) method and DTC.

DTC has distinctive advantages as compared with other used control systems in controlling electric motors. Just like the simple structure for performing, the lack of need to coordination transformations and producing PWM and also minor dependency to motor parameters, have caused DTC to be considered extensively in industrial and research fields. But this method has got problems, too. Two of the principle problems in DTC system are variable switching frequency and existence of large force ripples, of which

the reasons are using comparators for flux and force hysteresis. Using space vector modulation in direct force thrust control eliminates both problems [11]. Since in each sampling period in this method, there are definite numbers of non-null voltage vectors and null voltage vectors and thus the switching frequency is fixed and constant. Also, since in the classic method, as shows in Fig. 1, a table of switching for selecting and applying voltage vector to the motor, is used, a voltage vector, in the sampling period is constantly applied to the motor, and hence large ripples of forces are created. But in the method based on space vector modulation, and during sampling period, the voltage vectors are selected as a combination of non-null voltage vectors and null voltage vectors and therefore the force and flux errors are compensated. Thus, the ripples of force and flux are considerably reduced.

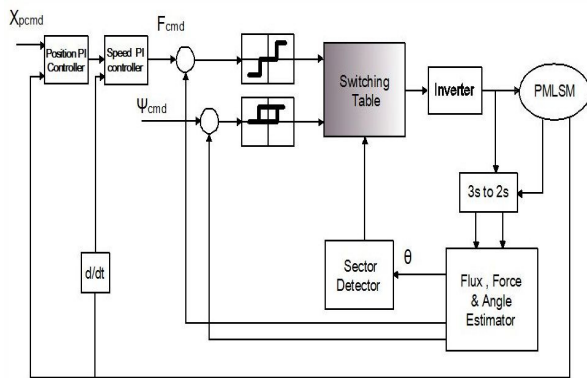

Fig.1. Diagram of motor direct force thrust control-PMLSM

In the systems without considering the non-linear behavior of a linear motor, the relevant behavior could create considerable errors in working of the system. Regarding this statement in this article, the permanent magnet linear synchronous mechanical model is accurately simulated, to show the motor dynamic behavior. The reductions in calculations, increasing calculations speed and reducing the necessary memory rate have also been considered. In this article, and by taking the simplicity of structure for DTC system into considerations as one of the most important characteristics of this method, in addition to eliminating the two problems of variability of switching frequency and existence of large ripples of forces, the simulation of the mechanical part of the motor with non-linear behavior and performing SVM that contains large amounts of calculations, was done by using a neural network, which causes considerable increase of calculations speed and reduction of system complications.

2. PMLSM MATHEMATICAL MODEL

In the applied controlling systems for alternative

current using motors, the machine models with d-q reference are mostly used. In this article, the equations for permanent magnet linear synchronous motor in rotor reference frames have been used. As compared to constant reference frame, the rotor reference frame rotates with angular velocity of " ω ". With regards to linear velocity of " V ", " ω " is defined as follows.

$$\omega = \frac{\pi}{\tau} V \quad (1)$$

where " τ " is the polar speed of permanent magnet and " V " is the motor linear velocity. The stator voltage equations are as follows.

$$u_d(t) = R i_d + \frac{d\Psi_d}{dt} - \omega \Psi_q \quad (2)$$

$$u_q(t) = R i_q + \frac{d\Psi_q}{dt} + \omega \Psi_d \quad (3)$$

where u_d and u_q are stator voltage space vector constituents in q and d axes direction, and i_d and i_q are the armature current vector constituents in the directions of q and d axes, and R is the armature phase resistance. The Ψ_d and Ψ_q fluxes of armature winding in q and d axes in the previous equations are as follows.

$$\Psi_d = L_d i_d + \Psi_{pm} \quad (4)$$

$$\Psi_q = L_q i_q \quad (5)$$

where L_d and L_q are armature inductances along d and q axes and Ψ_{pm} is the resultant flux of the permanent magnet. The electromagnetic force equation is, also as follows.

$$F = \frac{3}{2} \frac{\pi}{\tau} P (\Psi_d i_q - \Psi_q i_d) \quad (6)$$

3. CONTROLLER DESIGN

In this section the permanent magnet linear synchronous motor direct force thrust control is designed by using space vector modulation, but this modulation makes the control system complicated, and violates the main advantage for direct force thrust control, which is its simple structure. Therefore, space vector modulation is used based on neural network, which is simpler in addition to the fast that due to speeding up of the calculations, larger sampling frequencies could be used, that by itself could reduce the forces ripples. Also, in this part, the permanent magnet linear synchronous motor dynamic behavior is simulated by a neural network, that causes the performance of the offered method to be considered more appropriately.

3.1. Designing space vector modulation

To keep the switching frequency constant and more accurate compensation for flux and torque errors (in rotating motors), the space vector modular is being used in references [8, 11]. The diagram of direct force thrust control of permanent magnet linear synchronous

motors with space vector modulation is shown in Fig. 2.

As it can be observed, the table of switching and comparators of flux and force hysteresis are eliminated in this method, and instead, SVM and a predictive PI controller are used. The outer loop includes a velocity controller that generates the velocity signal, and the inner loop includes the flux and force controller, that produces suitable voltage vectors to reduce flux and forces errors. Since space vector modulation (SVM) is used in this system, the other excitation voltage vectors are not limited and suitable voltage vectors could be created to compensate flux and force errors. The diagram of flux and force controller block is shown in Fig. 3, in which the input flux signals are flux references and also the force errors and outputs are voltage vector references and SVM should create these voltage vectors accurately, by using appropriate schedules in a sampling period.

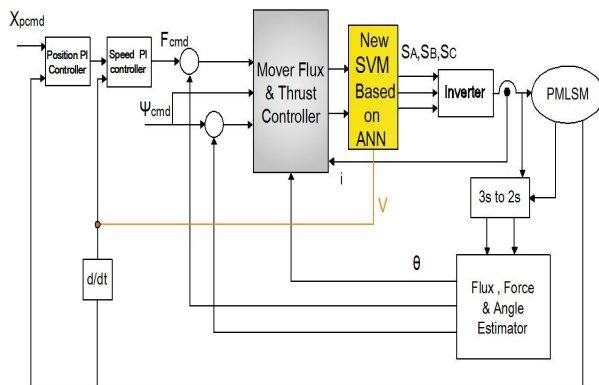

Fig. 2. Direct controlling of force – PMLSM, by using SVM

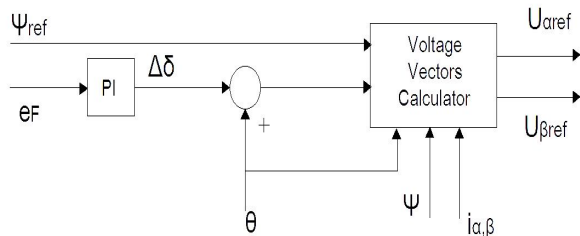

Fig. 3. The diagram of predictive PI controller

According to Fig. 4, that show space voltage vectors and different sectors, the working in structure is hereby described. Suppose the output vector is placed in section 0, and hence it should be created by voltage vectors of V_1, V_2, V_0 and V_7 and each of these voltage vectors should be applied in times T_1, T_2, T_{00} & T_{07} , as parts of the sampling period, to the motors. Thus the total times should be equal to a sampling period.

$$T_s = T_1 + T_2 + T_{00} + T_{07} \quad (7)$$

T_s is the sampling period. As it can be seen in the [8], the times for applying non-null voltage vectors and null voltage vectors, are calculated as follows.

$$T_1 = K * \cos\left(\theta + \frac{\pi}{6}\right) * T_s$$

$$T_2 = K * \sin(\theta) * T_s \quad (8)$$

$$T_0 = T_s - T_1 - T_2$$

In which $K = \sqrt{3} U_{out}/U_{dc}$ is the SVM coefficient. It can be observed by equations (8) that the reference voltage vector angle should be defined in each sampling period, and then the trigonometric functions of "sin" and "cos" should be calculated for that angle. Due to complications of the calculations of trigonometric functions and the calculations being timely, performing SVM creates problems such as increasing calculations and reducing the speed of calculations and limiting sampling frequency selections, despite considerably improving the control systems performance. A SVM, based on neural network is used for this paper that requires few calculations and reduces the current harmonics, effectively. The structure of the used BP network is shown in Fig. 5.

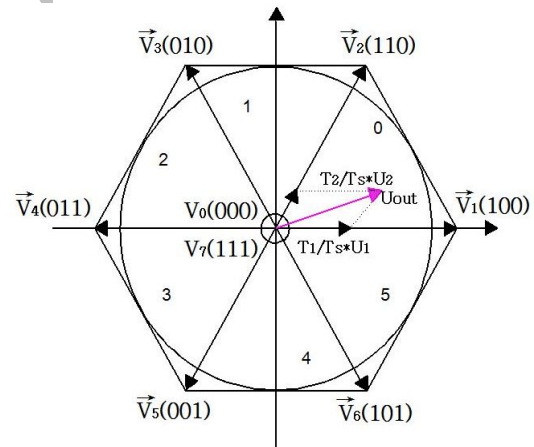

Fig. 4. Voltage space vectors.

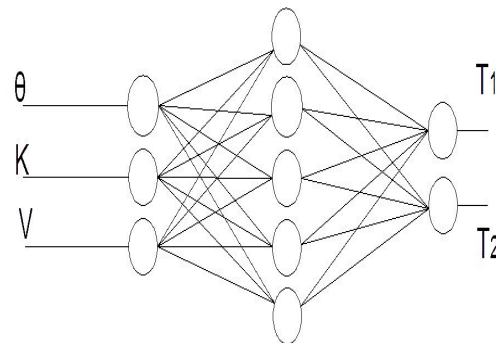

Fig.5. BP neural network, replacing SVM

The input of this BP network comprises of θ (the angle of reference voltage vector), K (modulation coefficient) and speed. The voltages are selected in proposed method with regards to speed affection on thrust force evolvment. In order that issue becomes clear, assuming motor in operation and positive rotational direction, an active voltage vector to increase the force must have components Q and D-axes positive and negative, respectively. However, back emf due to rotor speed reduces voltage effects, and force increment results more difficult at high velocities. On the contrary, if current force is too high a voltage vector having Q and D-axes components negative and positive respectively will be chosen. However, the force reduction is now boosted due to back emf, which makes force decreases more at high velocities. For this reason, in the proposed method linear speed is considered. Neural network outputs are the times T_1 and T_2 . To be trained for BP network, the Leven berg-Marquardt algorithm has been used. The trained weights of the ANN are obtained by training the proposed ANN offline with data selected from simulation of highly performance DTC of PMLSM.

3.2. Accurate Simulation of PMLSM Dynamic Behavior

Since the non-linear effects of PMLSM motor dynamic behavior on the performance of controlling system could not be neglected, the accurate model for dynamic behavior by using a neural network is used for this article. The equation of linear dynamic behavior is as follows.

$$F_e(t) = M_{tot} \frac{dv}{dt} + F_{Load}(t) + F_{friction}(v) \quad (9)$$

where M_{tot} is the sum of dynamic masses and loads, V is the rotor linear velocity, $F_{friction}$ is the frictional force and F_{load} is the added force by loads. Now, we consider friction. Up to now in the works done in this field, a multiplication of a constant coefficient in linear velocity is used for simulation of friction. But using this approximation is not an appropriate way to show the friction and it could not indicate the non-linear effects of friction; especially when the motor is working in low speed, which that show the precise importance in friction simulation. Suppose that the motor is working with a constant speed. Then the result by using motor dynamic behavior equation would be as follows.

$$M_{tot} \frac{dv}{dt} + F_{friction} = F_e \quad (10)$$

And since the motor is working with constant velocity ($M_{tot} \frac{dV}{dt} = 0$), we would have:

$$F_e = F_{friction} \quad (11)$$

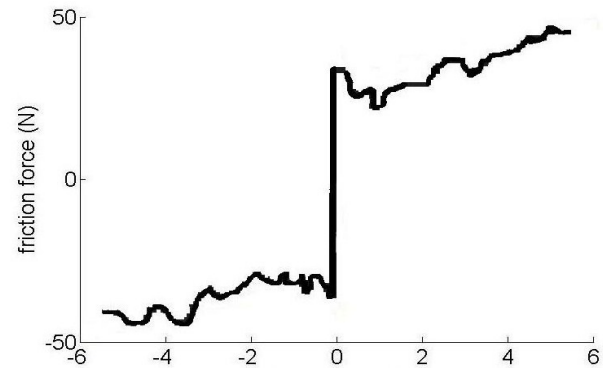

Fig.6. Relation of friction and velocity by experiments.

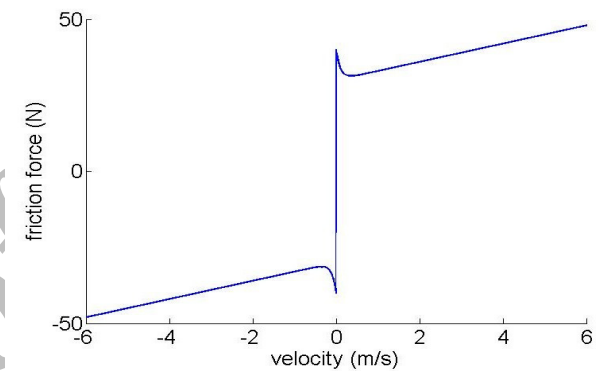

Fig.7. Relation of friction and velocity by using the simulation of a mathematical relation.

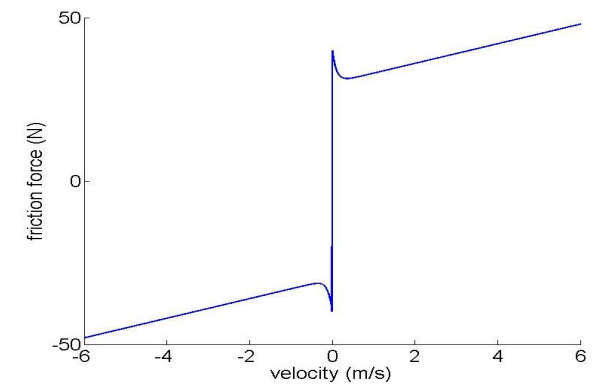

Fig.8. Relation of friction and velocity by using a neural network.

The relation of velocity and friction is given as a mathematical relation by using obtained data from the practical experiments in the reference [12], (The velocity/friction torque relationship as depicted by the experimental data is shown in Fig.6), which by simulating according to the mathematical relations, the changes of friction with respect to the changes of velocity, could be seen in Fig 7. A neural network is hereby taught by using this data that simulates non-linear behavior of friction in relation to the linear

velocity. The output of this neural network is shown in Fig 8. It can clearly be seen from these result that the neural network could properly simulate the non-linear effects of friction.

In Fig. 9 the motor velocity, by considering the accurate model of friction and velocity, in a situation where an approximate model for friction is used are compared to each other. In both cases, the situations are the same, but it can be seen that in the case where the accurate modeling of friction is used and due to weakening of thrust forces, especially in low velocities, the motor needs more time to follow up the situation in comparison with the case where the non-linear behavior of friction is not considered. By this comparison, the necessity of considering the non-linear effects of friction forces in the motor control system could be realized. Hence, the non-linear effects of friction forces are considered in all the simulations used for this article.

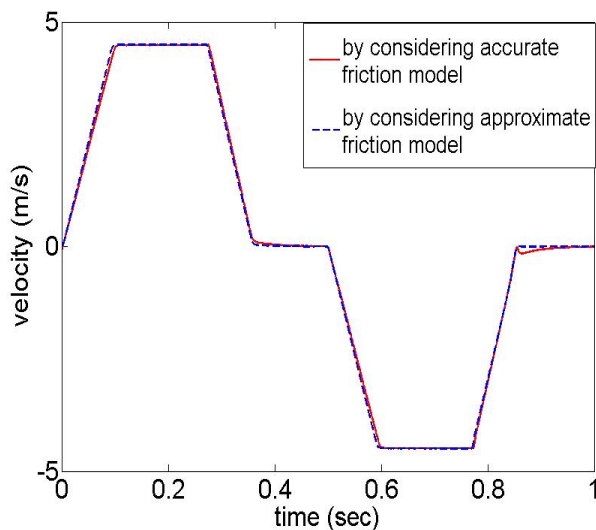

Fig.9. Comparison of velocity by considering accurate simulation of friction forces and also considering approximate friction force model

4. SIMULATION RESULTS

The diagram of the permanent magnet linear synchronous motor direct force thrust control that is shown in Fig. 10 is simulated in the Simulink environment of Matlab software and the results of DTC classic system and the offered system are compared with each other. The real and demanding forces by DTC classic system are shown in Figs. 11 and 12 and the demanding and real forces resulted by the proposed method are shown in Fig. 13. Stator fluxes of both methods are shown in Figs. 14 and 15. Also, the sampling frequency in the proposed method is chosen less than the classic system, but it can be seen that the results by the proposed method are considerably better than classic method.

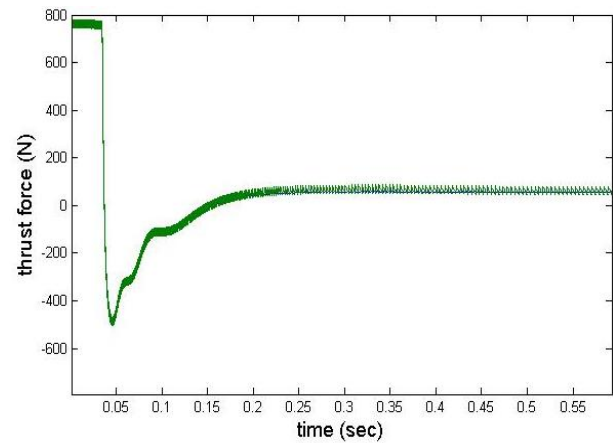

Fig.10. Reference and real forces in DTC method

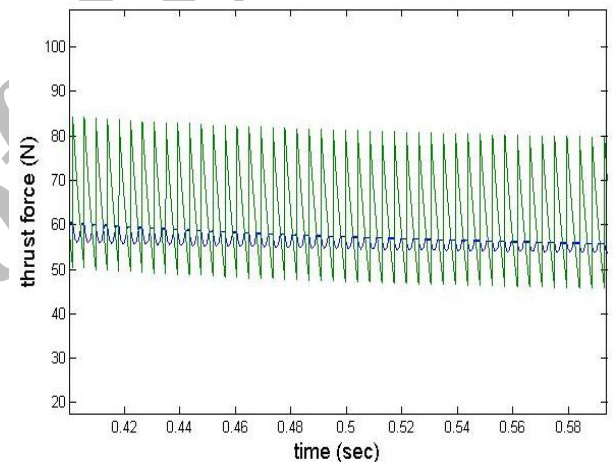

Fig.11. Reference and real forces in DTC method by magnification

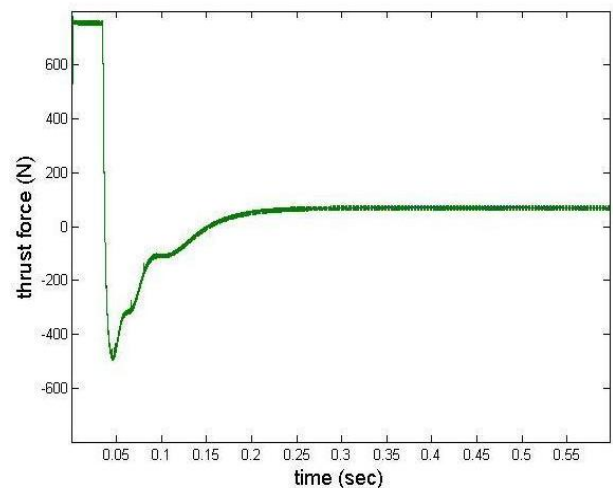

Fig.12. Reference and real forces in proposed DTC method.

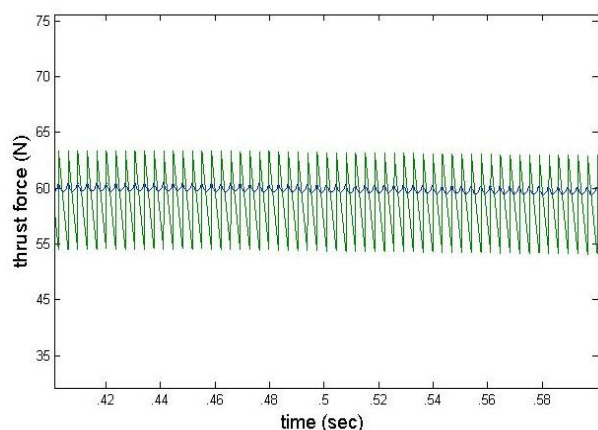

Fig.13. Reference and real forces in proposed DTC method by magnification.

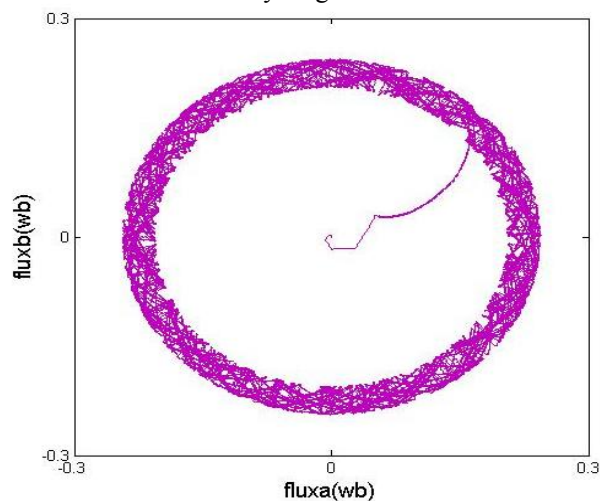

Fig.14. Geometric placement of stator flux in DTC method

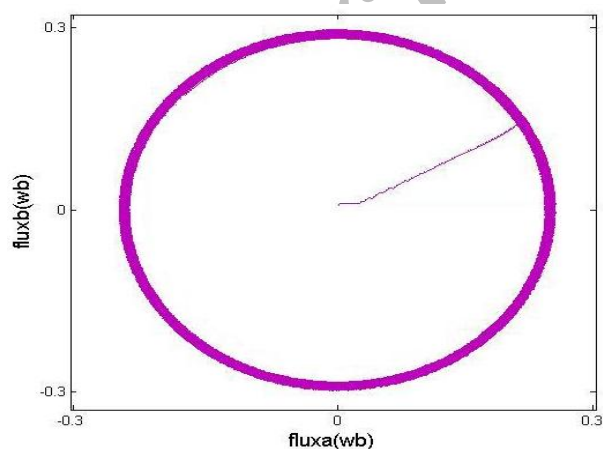

Fig.15. Geometric placement of stator flux in proposed DTC method, in this article

5. CONCLUSION

SVM is used for the aim to achieve suitable voltage

vectors to compensate force and flux errors and also constant switching frequency. The amount of calculations and complexity of the structure in SVM-DTC method are much more than classic DTC system.

In this paper using neural networks, possibility of using SVM method, without intricate the structure control, is feasible. In proposed neural network SVM, the linear speeds for its effects on thrust force evolvment have been considered. It has been shown that proposed SVM-DTC. By considering the linear speed is most successful than ordinary SVM-DTC. Finally, by simulating the dynamic behavior of a PMSM for its stable and reliable performance in using a SVM, based on neural network, was investigated. The obtained results of applying the offered method, clearly indicate the success and optimization of the proposed system. Hence by using this control system, and even in real situations that the mechanical parts have non-linear effects, a high performance drive on PMLSM could be fulfilled.

REFERENCES

- [1] P. Vaclavek, P. Blaha, "Lyapunov function based design of PMSM state observer for sensorless control", *IEEE/ISIEA*, pp.331-336, Kuala Lumpur, Oct. (2009)
- [2] G. Shahgholian, S.M.A. Zanjani, S. Eshtehardiha, "Modeling and simulation of the permanent magnet synchronous motor", *STA*, pp.1-10, Monastir Tunisia, Nov. (2007)
- [3] M. Depenbrock, "Direct self-control (DSC) of inverter-fed induction machine", *IEEE Transaction on Power Electronics*, Vol.3, No.4, p.420-429, Oct. (1988)
- [4] L. Zhong, M.F. Rahman, W.Y. Hu, K.W. Lim, "Analysis of direct torque control in permanent magnet synchronous motor drives", *IEEE Transaction on Power Electronics*, Vol.12, No.3, pp.528-536, May (1997)
- [5] B. Kwon, K. Woo, S. Kim, "Finite element analysis of direct thrust-controlled linear induction motor", *IEEE Transactions on Magnetics*, Vol.35, No.3, pp.1306-1309, May (1999)
- [6] D. Casadei, G. Serra, K. Tani, "Implementation of a direct control algorithm for induction motors based on discrete space vector modulation", *IEEE Transaction on Power Electronics*, Vol.15, No.4, pp.769-777, July (2009)
- [7] C.G. Mei, S.K. Panda, J.X. Xu, K.W. Lim, "Direct torque control of induction motor-variable switching sectors", *IEEE/PEDS*, Vol.1, pp.80-85, July (1999)
- [8] L. Tang, L. Zhong, M.F. Rahman, Y. Hu, "A novel direct torque controlled interior permanent magnet synchronous machine drive with low ripple in flux and torque and fixed switching frequency", *IEEE Transaction on Power Electronics*, Vol.19, No.2, pp.346-354, March (2004)
- [9] J. Yang, G. He, J. Cui, "Analysis of PMLSM direct thrust control system based on sliding mode variable structure", *IEEE/IPEMC*, Vol.1, pp.1-5, Shanghai, Aug. (2006)

- [10] Y.S. Huang, C.C. Sung, “**Function-based controller for linear motor control systems**”, *IEEE Transactions on Industrial Electronics*, Vol.57, No.3, pp.1096-1105, March (2010)
- [11] G. Foo, M.F. Rahman, “**A novel speed sensorless direct torque and flux controlled interior permanent magnet synchronous motor drive**”, *IEEE/PESC*, pp.50-56, Rhodes, June (2008)
- [12] C. Makkar, W.E. Dixon, W.G. Sawyer, G. Hu, “**A new continuously differentiable friction model for control systems design**”, *IEEE/ASME*, pp.600-605, Monterey, July (2005)

Archive of SID