

Optimal Calculation of Induction Heater Capacitance with Developed Bacteria Foraging Algorithm

Amin Emanian¹, Ehsan Daryabeigi², Morteza Asadi Zeidabadi³

1- Department of Electrical Engineering, Tiran Branch, Islamic Azad University, Isfahan, Iran.

Email: a_emanian@yahoo.com

2- Young Researchers Club, Najafabad Branch, Islamic Azad University, Najafabad, Iran.

Email: edaryabeigi@ieee.org

3- Tehran Electrical Distribution Company (TEDC), Tehran, Iran.

Email: m.asadi@ieee.org

Received: March 2012

Revised: June 2012

Accepted: August 2012

ABSTRACT:

In designing a parallel resonant induction heating system, choosing a proper capacitance for the resonant circuit is quite important. The capacitance affects the resonant frequency, output power, heating efficiency and power factor. In this paper, with consideration to function of the equivalent series resistance (ESR), optimal capacitance is calculated. The induction heating resonance capacitor is achieved using Smart Bacteria Foraging Algorithm (SBFA) under voltage and frequency constraints for minimizing cost function that is including: increasing the output power and efficiency of an induction heater, while decreasing the power loss of the capacitor. The proposed algorithm mimics chemotactic behavior of *E.Coli* bacteria to optimize parameters. The proposed algorithm enjoys individual and social intelligence, so that it can search influx ways among hidden layers of the problem. Based on the equivalent circuit model of an induction heating system, the output power, and the capacitor losses are calculated. The effectiveness of the proposed method is verified by computer simulations, also improving the obtained results using SBFA are compared to classical bacteria foraging algorithm BFA.

KEYWORDS: induction heating, capacitance, bacteria foraging, resonant frequency, equivalent series resistance.

1. INTRODUCTION

Because of the high efficiency, precise control and low pollution properties, the induction heating is widely used not only in the industrial fields, but also in the home appliances. One of the interests is its applications in metal industry for melting or heating of thin slab in a continuous casting plant because of good heating efficiency, high production rate, and clean working environments. A typical parallel resonant inverter circuit for induction heater is shown in Fig. 1[1,2].

In the parallel resonant inverter, if the switching frequency is close to the resonant frequency, higher voltage is generated at capacitor bank [3]. However, due to the limit in the voltage tolerance of the capacitor bank, the inverter output voltage V_C needs to be limited below the rated voltage V_{max} . One method of limiting V_C is to reduce the DC-link current I_{dc} by increasing the firing angle of the rectifier. However, the result is decrease of the output power. At the mini-mill in a POSCO steel plant, there are some induction heaters, which were installed to heat thin slabs in order for next milling process continually. However, there were two

problems: One was the insufficiency in the output power and efficiency, and another was the frequent damages of the capacitor bank. Insufficiency in output power was caused by a poor power factor of the inverter. On the other hand, the damage to the capacitor bank was due to a little voltage margin between V_C , V_{max} , and it resulted in a large power dissipation in the capacitor causing a high temperature rise [3].

Several attempts have been proposed to solve these problems such as optimal design of power devices [4], and proper control of the inverter switches [5] [6].

Various optimization methods, such as direct search method, evolution strategy (ES) and simulated annealing method (SAM) were applied to the optimal design of induction heater [6].

In [7], an optimal value of the capacitance only under the voltage constraint was found based on the Lagrange multiplier. In the mentioned method, the switching and resonant frequency were not considered as an important parameter in the capacitance selection. As well, calculating the optimum capacitance needs to solve two nonlinear complex algebraic equations by the method [7].

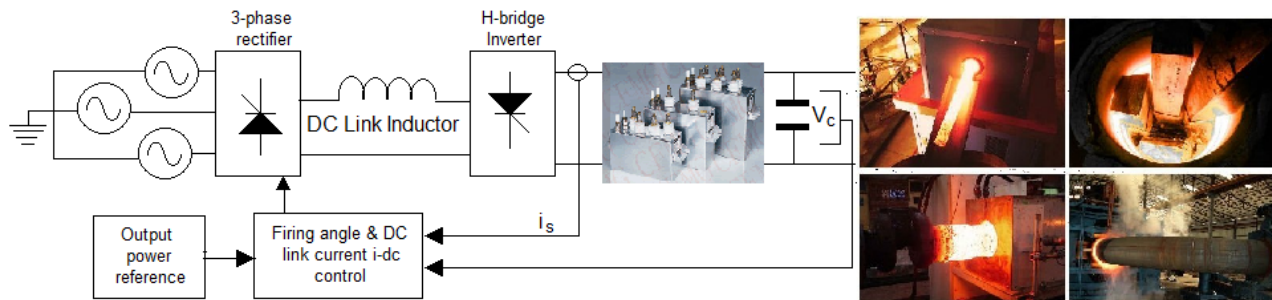

Fig. 1. a) Block diagram of induction heating system, b) a small sample of the induction heater.

As well as the evolutionary computation techniques the GA is based on principles of evolution [8]. Based on its demonstrated ability to reach near-optimum solutions to large problems, the GA technique has been used in many applications in science and engineering [8]. Despite their benefits, GA may require long processing time for a near optimum solution to evolve. Furthermore, its operation is included by alternative motion around the optimal point [9].

In a research article, GA was used to calculate the capacitance of an induction heater. Although that has shown improvement of the result than a classical method, resonant frequency restriction hasn't considered properly [9]. Actually, either studied articles haven't taken into account this limitation, which can make more complex the problem than past.

One of the optimization methods that recently that has been used for different applications is the bacterial foraging algorithm (BFA) which was proposed in 2002, by Prof. K. M. Passino. It is based on the foraging strategies of the E. Coli bacterium cells [10]. After introducing the algorithm, a few successful applications have been done in power systems specially [10-14]. But in order to modify and improve the classical BFA, smart bacteria foraging algorithm SBFA was introduced in [11]. The proposed algorithm SBFA considers both social and individual intelligence of bacteria, so that bacteria can conduct at a smart direction by performing tumble with a unit of length smartly. This approach leads to have a more decrease in cost function and a higher speed convergence than BFA.

The capacitance of the capacitor bank affects the overall operating factors of the induction heater such as resonant frequency, efficiency, and power factor [9]. Hence, in this work, we propose a method of choosing optimal capacitance value C_{opt} using SBFA, which begets a trade-off between the maximum output power, and efficiency with consideration to user's aims by selecting cost function. The capacitance is found by defining an objective function that includes output power, power loss, switching frequency and efficiency.

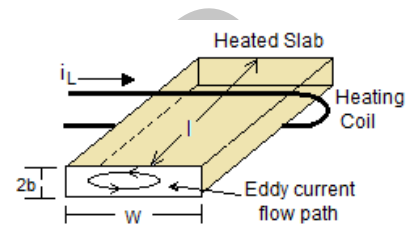

Fig. 2. Model of slab for one turn coil.

At the first step, an equivalent model of the induction heater is developed based on previous works [7]. The heating coil and slab are modeled as an inductance plus a series resistance, and the capacitor bank is modeled as a pure capacitance with an equivalent series resistance (ESR). In next section, proposed algorithm SBFA is outlined. Then optimal capacitance is achieved by select of proper objective function.

2. TECHNICAL WORK PREPARATION

2.1. Equivalent Circuit

In general, the heating coil and the load are modeled as a transformer with a single turn secondary winding as shown in Fig. 3(a). Almost all magnetic flux generated by the induction coil (primary winding) penetrates into the slab (secondary winding). Hence, in the secondary circuit, no leakage inductance appears and the coupling coefficient is equal to one. The secondary circuit can be moved to the primary part as shown in Fig. 3(b). The slab resistance R_L for one turn coil is given by:

$$R_L = \rho \frac{L}{A} = \rho \frac{2(\omega + 2b)}{l\delta}, \quad (1)$$

where L and A are length and area of eddy current, l is the effective length of the slab occupied by one turn coil and b and w are defined in Fig. 2, δ and ρ are skin depth almost distributed over the surface of slab and electrical resistivity of the material. Simplified equivalent model for a transformer can be represented in Fig. 3(c) by a same inductance L_{eq} and resistance R_{eq} [1]. These equivalent parameters, depend on several variables including the shape of the heating

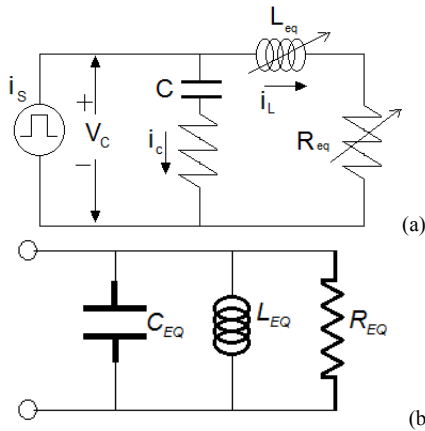

Fig. 3. a) Equivalent circuit of the induction heater.
b) Simplified equivalent circuit of the induction heater.

coil, the spacing between the coil and slab, the electrical conductivity and magnetic permeability of the slab, and the angular frequency of the varying current ω_s .

$$L_{eq} = L_1 - A^2 L_2, \quad (2)$$

$$R_{eq} = R_1 + A^2 R_L, \quad (3)$$

where R_1 denotes the resistance of the heating coil, R_L denotes the resistance of the heated slab, and $A = \omega_s L_M / \sqrt{\omega_s^2 L_2^2 + R_L^2}$. It is noted that the inductance of heating coil L_1 is not affected by the existence of the slab in the heating coil, since at about 1100°C temperature the permeability of the iron slab is equal to that of air, i.e., $\mu = 4\pi \times 10^{-7}$ (H/m) [7].

To represent the power dissipation in the capacitor bank, it is modeled by a pure capacitance C and an equivalent series resistance (ESR) R_{ESR} . It is noted that R_{ESR} is inversely proportional to the Capacitance, hence, it is modeled as $R_{ESR} = k/C$, where k is a coefficient of ESR ranged from $1.2 \times 10^6 < k < 1.5 \times 10^6 \Omega f$.

2.2. Power Equation

A useful variable to calculate the power is total impedance seen from the impedance of the equivalent circuit in Fig. 3(c). The total impedance is given by:

$$\begin{aligned} Z_t &= \frac{(Z_C + Z_{ESR}) \cdot (Z_L + Z_R)}{Z_L + Z_R + Z_C + Z_{ESR}} \\ &= \frac{(\omega_s k R_{eq} + \omega_s L_{eq}) + j(\omega_s^2 L_{eq} k - R_{eq})}{\omega_s (C R_{eq} + k) + j(\omega_s^2 L_{eq} C - 1)}, \end{aligned} \quad (4)$$

where $Z_L = j\omega_s L_{eq}$, $Z_C = 1/j\omega_s C$, $Z_R = R_{eq}$ and $Z_{ESR} = R_{ESR} = k/C$.

The rectifier and H-bridge inverter of the induction heater are represented by a square waved current source whose magnitude is equal to the DC-link current I_{dc} . Therefore, the current source expanded in a Fourier series is described as follows:

$$i_s(t) = \sum_{n=1}^{\infty} \frac{4I_{dc}}{n\pi} \sin n\omega_s t, \quad n=1, 3, 5 \dots \quad (5)$$

The first harmonic amplitude is equaled as follows:

$$I_s = 4I_{dc} / \pi \quad (6)$$

The current through R_{eq} and R_{ESR} are represented by i_L and i_C , respectively. The phasor expression of i_L and i_C are described as follows:

$$I_L = \frac{V_C}{Z_L + Z_R} = \frac{Z_C + Z_{ESR}}{Z_L + Z_R + Z_C + Z_{ESR}} I_s, \quad (7)$$

$$I_C = \frac{V_C}{Z_C + Z_{ESR}} = \frac{Z_L + Z_R}{Z_L + Z_R + Z_C + Z_{ESR}} I_s, \quad (8)$$

where V_C and I_s are phasors of v_C and i_s and $V_C = Z_t \cdot I_s$. In Fig. 3(c), the power consumption is accomplished by equivalent resistor R_{eq} and ESR R_{ESR} of the capacitor bank. Therefore, the output power of the induction heater P_{out} and the capacitor loss P_{loss} are given by:

$$P_{out}(C) = \left(\frac{I_L}{\sqrt{2}} \right)^2 Z_{eq} = \frac{1}{2} \left| \frac{Z_C + Z_{ESR}}{Z_L + Z_R + Z_C + Z_{ESR}} \right|^2 I_s^2 Z_{eq} \quad (9)$$

$$\frac{8I_{dc}^2}{\pi^2} \left| \frac{\omega_s k - j}{\omega_s C (R_{eq} + \frac{k}{C}) + j(\omega_s^2 C L_{eq} - 1)} \right|^2 R_{eq}$$

$$P_{loss}(C) = \left(\frac{I_C}{\sqrt{2}} \right)^2 Z_{ESR} = \frac{1}{2} \left| \frac{Z_L + Z_R}{Z_L + Z_R + Z_C + Z_{ESR}} \right|^2 I_s^2 Z_{ESR} \quad (10)$$

$$\frac{8I_{dc}^2}{\pi^2} \left| \frac{\omega_s C (R_{eq} + j\omega_s L_{eq})}{\omega_s C (R_{eq} + \frac{k}{C}) + j(\omega_s^2 C L_{eq} - 1)} \right|^2 \frac{k}{C}$$

where I_L, I_C denote the peak of i_L, i_C respectively [5].

It is noted that P_{out} and P_{loss} are functions of capacitance C , since all the parameters except capacitance are known values in (9) and (10).

In the load commutated inverter, the switching frequency of the inverter must be higher than the resonant frequency of the L-C load to guarantee commutation of the thyristors [2-4]. Hence, for more suitable value for the inverter while working close to the resonant frequency, we let $\omega_a = 1.1\omega_0$, and then the voltage constraint is given by

$$V_C = |Z_t(j\omega_s)| \cdot I_s = |Z_t(j1.1\omega_0)| \cdot \frac{4}{\pi} I_{dc} \leq V_{max}, \quad (11)$$

where V_C stands for voltage peak of the capacitor v_C , V_{max} is rated voltage of the capacitor bank, and Z_t is total impedance of capacitor bank and heating parts.

3. SMART BACTERIA FORAGING ALGORITHM

This supposed that we want to find the minimum of $J(\theta)$, $\theta \in \mathfrak{R}^p$.

3.1. Initialization

- 1) Number of parameters (p) to be optimized;
- 2) Number of bacteria (S) to be used for searching the total region;
- 3) Swimming length N_s after tumbling of bacteria will be undertaken in a chemotactic loop;
- 4) The number of iterations to be undertaken in a chemotactic loop $N_c > N_s$;
- 5) N_{er} The maximum number of reproduction to be undertaken;
- 6) N_{ed} The maximum number of elimination and dispersal events to be imposed over the bacteria;
- 7) $\rho_{e,d}$ The probability which the elimination and dispersal will continue;
- 8) The location of each bacterium $P(i, j, k)$ which is specified by $P(i, j, k) = \{\theta^i(j, k, l) | i = 1, 2, \dots, S\}$;
- 9) The value of basic chemotactic step size " $C(i)$ " for $i = 1, 2, \dots, S$ is assumed to be constant in our case for all of the bacteria to simplify the design strategy;
- 10) To represent a tumble, a random direction unit length between (0,1), say $\varphi(j)$, is generated. This will be used to define the direction of movement after a tumble by using $\beta(i)$. The value of $\varphi(j)$ is represented by:

$$\varphi(i) = \beta(i) \frac{\Delta(i)}{\sqrt{\Delta^T(i)\Delta(i)}} \quad (12)$$

where $\beta(i) : \{\beta_m(i) | m = 1, 2, \dots, p\}$ is 1 or -1 and $\Delta(i) \in R^p$, $\{\Delta_m(i) | m = 1, 2, \dots, p\}$ is a random number on (0,1]. Furthermore, $\beta(i)$ at first is chosen randomly and then changes with attention to the cost function smartly. The classical BFA algorithm is rewritten with this new $\varphi(i)$ for smart bacteria movement after a tumble.

3.2. The Iterative Algorithm for Optimization

This section presents models of the bacterial population chemotaxis, swarming, reproduction, elimination and

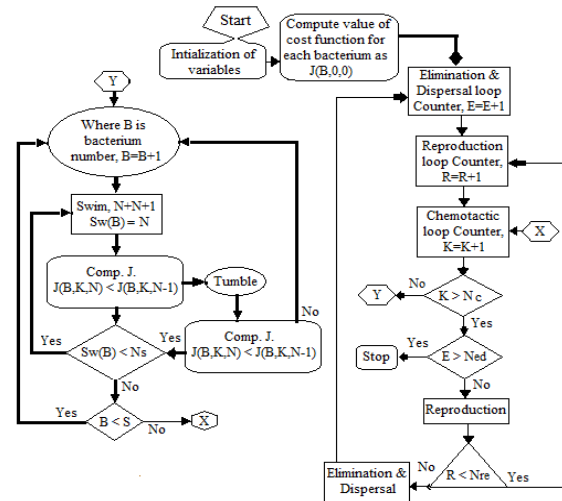

Fig.4. The flowchart of SBFA.

dispersal (initially $j=k=l=0$ and θ^i are chosen randomly).

Step 0) Initialization of variables $\Delta(i)$, $\beta_0(i)$ and θ_0^i randomly. For $i = 1, 2, \dots, S$, calculate the cost function value for each bacterium using initial variables ($j=k=l=0$), as follows.

- Compute the value of the cost function $J(i, j, k, l)$ that:

$$J_{sw}(i, j, k, l) = J(i, j, k, l) + J_{CC}(\theta^i(j, k, l), P(j, k, l)) \quad (13)$$

($J_{CC}(\theta)$ is used to model the cell-to-cell signaling via an attractant and a repellent of bacteria swarming).

- Let $J_{last}^i = J_{sw}(i, j, k, l)$ and $J_{last} = \min_{i=1, 2, \dots, S} (J_{last}^i)$ to save this value since a better cost via a run may be found.
- End of for loop

Step 1) Elimination-dispersal loop $l = l + 1$.

Step 2) Reproduction loop $k = k + 1$.

Step 3) Chemotaxis loop $j = j + 1$.

a) For $i = 1, 2, \dots, S$ calculate the cost function value for each bacterium i as follows.

- Compute the value of cost function $J(i, j, k, l)$.

• Let $J_{last}^i = J_{sw}(i, j, k, l)$ and

$J_{last} = \min (J_{last}^i), i = 1, 2, \dots, S$ to save this value since we may find a better cost via a run.

- End of for loop

b) For $i = 1, 2, \dots, S$, take the tumbling/swimming decision.

- **Tumble:** Generate a random vector $\Delta(i)$ with each element.
- **Move:** let

$$\theta^i(j+1, k, l) = \Gamma = \theta^i(j, k, l) + C(i) \cdot \beta(i) \cdot \frac{\Delta(i)}{\sqrt{\Delta^T(i)\Delta(i)}} \quad (14)$$

The fixed step size in the direction of tumble for bacterium is considered.

• Compute $J_{sw}(i, j+1, k, l)$.

• **Swim:**

1) Let $N = 0$; (counter for swim length);

2) While $N < N_s$ (have not climbed down too long).

• let $N = N + 1$

• If $J_{SW}(i, j+1, k, l) < J_{last}^i$ let $J_{last}^i = J_{SW}(i, j+1, k, l)$

And then:

$$\theta^i(j+2, k, l) = \theta^i(j+1, k, l) + C(i) \cdot \beta(i) \cdot \frac{\Delta(i)}{\sqrt{\Delta^T(i)\Delta(i)}} \quad (15)$$

And use this $\theta^i(i, j+1, k, l)$ to compute the new $J(i, j+1, k, l)$.

• Else, let: $\beta(i) = -\beta(i)$ and

$$\theta^i(j+1, k, l) = \theta^i(i, k, l) + 2C(i) \cdot \beta(i) \cdot \frac{\Delta(i)}{\sqrt{\Delta^T(i)\Delta(i)}} \quad (16)$$

• Compute $J_{sw}(i, j+1, k, l)$.

• If $J_{SW}(i, j+1, k, l) < J_{last}^i$ let $J_{last}^i = J_{SW}(i, j+1, k, l)$ and let:

$$\theta^i(j+2, k, l) = \theta^i(j+1, k, l) + C(i) \cdot \beta(i) \cdot \frac{\Delta(i)}{\sqrt{\Delta^T(i)\Delta(i)}} \quad (17)$$

And use the $\theta^i(i, j+2, k, l)$ to compute the new $J(i, j+2, k, l)$.

• Else let $N = N_s$, $\theta(i, j+1, k, l) = \Gamma$ and $J_{sw}(i, j+1, k, l) = T$. This is the end of the while statement.

c) Go to the next bacterium $i = i + 1$ if $i \neq S$ (i.e., go to

b) to process the next bacterium.

Step 4) If $j < N_c$, go to Step 3). In this case, continue chemotaxis since the life of the bacteria is not over.

Step5) If $l > N_{ed}$, The algorithm stops.

Step 6) Reproduction

a) For the given k and l , and for each $i = 1, 2, \dots, S$, let

$J_{health}^i = \min\{J_{SW}(i, j, k, l)\}$, $j \in \{1, \dots, N_c\}$ be the health of the bacterium (a measure of how much nutrients received over its lifetime and how successful it was at avoiding noxious substances). Sort bacteria in order of ascending cost J_{health} (higher cost means lower health).

b) The $S_r = S/2$ bacteria with the highest values J_{health} die and other S_r bacteria with the best value split (and the copies that are made are placed at the same location as their parent).

Step 7) If $k < N_r$, go to 2. In this case, we have not reached the number of specified reproduction steps, so we start the next generation in the chemotactic loop.

Step 8) Elimination dispersal: after sorting bacterium in order of ascending cost J_{health} (higher cost means lower health), for $i = S_{e,d}, S_{e,d} + 1, \dots, S$, ($S_{e,d} = nS, \{n < 1\}$) with probability $\rho_{e,d}$, eliminate and disperse each bacterium (this keeps the number of bacteria in the population constant) to a random location on the optimization domain. After that, go to 1 [10-11].

4. IMPLEMENTATION OF SBFA ALGORITHM FOR OPTIMIZATION

Select of a suitable performance index is extremely important for the design of induction heating. The optimal induction heating parameters shall be obtained by minimizing J , and the aim is selection of suitable capacitance, such as increase of output power, decrease of loss and also voltage and switching frequency constraints are satisfied. Where desired of parameters: 1-Ferquence f_s (that with attention to industrial making constraints of high frequency inverters can't increase to each value specific for high powers.) 2-efficiency 3- output power 4- difference output power with power loss 5- capacitance value (with attention to this pattern that higher capacitance is more expensive and larger than other, therefore must is used less capacitance within possible limit). Now, coefficients and weights must be imputed to functions of mentioned parameters that show its importance rate.

$$J = \frac{1}{(P_{out}(c) - P_{loss}(c))^2} + 0.995^{\left(\frac{P_{out}}{75e3} - 1\right)} f_s^{0.0005} \quad (18)$$

$$+ C + 100 \frac{1}{P_{out}} + 0.87^{\left(\frac{P_{out}}{75e3} - 1\right)} \frac{1}{\eta} \quad (19)$$

$$\eta = \frac{P_{out}(c)}{P_{out}(c) + P_{loss}(c)} \times 100 \quad (19)$$

$$|Z_t(J1.1\omega_0)| \cdot \frac{4}{\pi} I_{dc} \leq V_{max}, \quad (20)$$

$$(CR_{eq}^2 - L_{eq}) / (CR_{esr}^2 - L_{eq}) > 0$$

Minimization of J that is equal to maximization of the output power ($P_{out} - P_{loss}$), defines suitable and minimum values of f_s and C , and maximization efficiency. With attention to the said subjects about mentioned parameters, frequency value

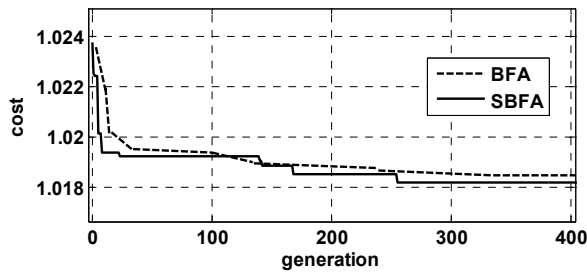

Fig. 5. BFA and SBFA objective functions amount variation with iterations.

has to decrease in high powers. Therefore, in this position must have upper weight, and effect of minimizing was more than position of low power. The weights numerical values are achieved by trial and error proportional to a few optimal characteristic models. Parameters of the POSCO induction heater are given as following:

$$L_{eq} = 8.3 [\mu H], R_{eq} = 0.053 [\Omega], V_{max} = 170V, I_s = 1300A, \\ K = 1.35 \times 10^{-6} [\Omega f] [7].$$

Table 1. Parameters of the Induction Heating

	J	P _{Out} kW	η	f _s kHz	V	C _{eq} [mf]
SBFA	1.0182	469.94	76.76%	5.492	1226.6	117.76
BFA	1.0196	477.07	76.18%	5.665	1273.5	110.96

5. SIMULATION RESULTS

Simulation was performed with MATLAB software. With the use of SBFA, the optimal capacitance value is found to be $C = 117.76 [\mu F]$ by minimization (18) and attention to (20). SBFA parameters are given in table II. Results of SBFA performance is shown in fig.4, which move to minimum value of objective function J (18). Additionally, the process is done by using classical BFA for compared to the proposed algorithm. Using SBFA improve optimization process than classical BFA Fig. 5.

Curves of output power P_{out} , power loss P_{Loss} and difference between both of them $P_{Out} - P_{Loss}$ versus capacitance C of the mentioned system are indicate in Fig.(6), which shows by decreasing the capacitance C , output power is increased, but only in the allowable area (with consideration to the constraints (20)). Values of cost function and switching frequency are given in figures 7, 8 versus variations of capacitance value, respectively.

Although the type of the cost function depends on user's aims, for example, if rate of power output is more concerned than efficiency, weigh of the

term $P_{out} - P_{loss}$ is increased more than the others. Also, according to Fig. 9, capacitance voltage is lower than

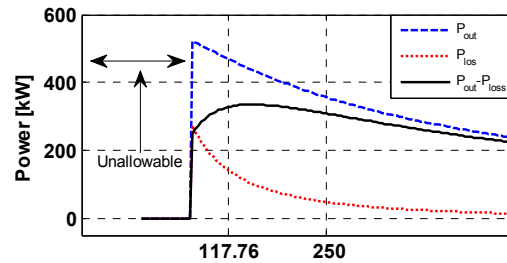

Fig. 6. courses of output power, power loss and difference between both of them.

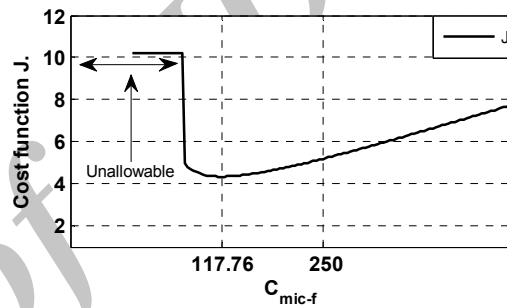

Fig. 7. Cost function J respect to the capacitance values C .

voltage rate V_{max} . Just as was said this place is same optimal point.

6. DISCUSSION

This paper presents a novel method for optimal select capacitance and suitable switching frequency, with considerations of tolerance of voltage and frequency, ESR of capacitance, maximum output power and high power factor. Parts of unallowable that are shown on figures resulted from equation (20).

As one of the main achieved results, the proposed procedure is based on a multi-objective function. In this regard, several aspects, including economic and technological limitations are taken into account. The economic aspect is related to the ratio of energy cost to profit from the production of the induction furnace. In other words, in areas with cheaper energy, induction furnace output power is more important. The second factor in the design objective function, constraints related to semiconductor technology and electric devices. At higher power, the inverter switches operate at lower frequencies. Furthermore, due to restrictions in industry, capacitors with higher power values are smaller.

Another point that should be mentioned, it can be used effectively to optimize pre-fabricated and installed induction furnaces with minimum cost.

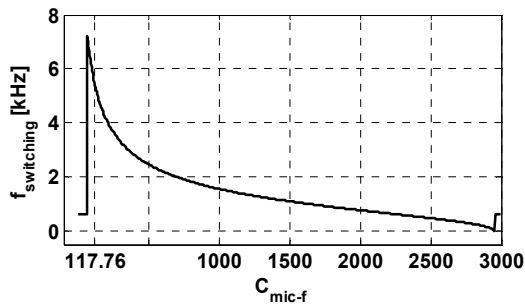

Fig. 8. switching frequency respect to the capacitance values C .

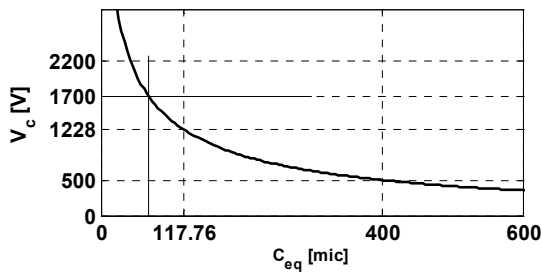

Fig. 9. The capacitance voltage.

Table 2. PARAMETERS OF SBFA

$N_c=10$	N. of iterations	$S=16$	N. of bacteria
$N_s=10$	Swimming length	$P=1$	N. of parameters
$N_r=8$	N. of reproduction	$N_{e,d}=10$	N. of elimination
$P_{e,d}=30\%$	Probability of elimination & p.	$d_s=0.0002$	swimming step
117.76 μf		Optimal capacitance	
1.0182		Final value of C. Function	

7. CONCLUSION

This paper suggests a new method in choice of capacitance and operating frequency for an induction heater, with considerations on voltage tolerance and ESR of the capacitor, maximum output power, high power factor, and switching frequency. The optimal solution is found by SBFA and defining an objective function that includes output power, loss power, efficiency and switching frequency. Taking into account the frequency and voltage constraints, the optimal value is obtained, which increases the life time of the capacitor bank and generates a suitable output power. Simulation results confirm better tradeoff between improvements of efficiency and decreasing the switching frequency. In one hands, raising power output in the other hand in comparison with the classical BFA. The proposed method can be use in industrial scales usefully.

REFERENCES

- [1] H. Jiang, T.H. Nguyen, M. Prud'homme, "Optimal control of induction heating for semi-solid aluminum alloy forming", Elsevier, *Journal of Materials Processing Technology*, vol. 189, pp. 182–191, 2007.
- [2] M. Kranjc, A. Zupanic, D. Miklavcic, T. Jarm, "Numerical analysis and thermographic investigation of induction heating", Elsevier, *International Journal of Heat and Mass Transfer* 53 3585–3591, 2010.
- [3] F.P. Dawson, and P. Jain, "A comparison of load commutated inverter systems for induction heating and melting applications", *IEEE Trans. On Power Electronics*, Vol. 6, No. 3, pp. 430 -441, July, 1991.
- [4] M. Horii, N. Takahashi and T. Narita, "Investigation of Evolution Strategy and Optimization of Induction Heating Model", *IEEE Trans. on Mag.*, vol. 36, no. 4, pp. 1085-1088, Jul. 2000.
- [5] W. S. Choi, I. Ju Pa, D. Yun Lee and D. S. Hyun, "A New Power Control Scheme of Class-D Inverter for Induction Heating Jar Application with Constant Switching Frequency", *Conf. IEEE Indus. Electron.* Pp. 784-789, Soc. Nov. 2 - 6, Buean, Korea, 2004.
- [6] Y. Favennec, V. Labbe, F. Bay, "Induction heating processes optimization a general optimal control approach", Elsevier, *Journal of Computational Physics*, vol. 187, pp. 68–94, 2003.
- [7] J. Lee, S. Lim, K. Nam, D. Choi, "An Optimal Selection of Induction Heater Capacitance Considering Dissipation Loss Caused by ESR", *IEEE Trans. Ind. Appl.*, vol. 43, no. 4, pp. 1117 – 1125, 2007.
- [8] Krishnanand K.R, B.K.Panigrahi, Santanu Kumar Nayak, P.K.Rout, "Comparative Study of Five Bio-Inspired Evolutionary Optimization Techniques", *Conf. IEEE, NaBIC*, pp. 1231-1236, 2009.
- [9] G. R. Arab Markadeh, E. Daryabeigi, "An optimal selection of induction heating capacitance by genetic algorithm considering dissipation loss caused by esr", *IJE Transactions B: Applications*, March 11, 2010.
- [10] K.M. Passino, "Biomimicry of bacterial foraging for distributed optimization and control, *IEEE Control Systems Magazine*", pp.52– 67, 2002.
- [11] E. Daryabeigi, M. Moazzami, A. Khodabakhshian, M. H. Mazidi, "a new power system stabilizer design by using smart bacteria foraging algorithm", *IEEE Conf. CCECE*, pp. 713-716, Niagara, Canada, 2011.
- [12] Mishra, S. "A hybrid least square-fuzzy bacterial foraging strategy for harmonic estimation". *IEEE Trans. on Evolutionary Computation*, vol. 9(1): 61-73, 2005.
- [13] S. Mishra, and C. N. Bhende, "Bacterial Foraging Technique-Based Optimized Active Power Filter for Load Compensation", *IEEE Trans. on POWER DELIVERY*, vol. 22, no. 1, pp.457-465, Jan. 2007.
- [14] W. J. Tang, M. S. Li, Q. H. Wu, and J. R. Saunders, "Bacterial Foraging Algorithm for Optimal Power Flow in Dynamic Environments", *IEEE, Trans. on Circuits and Sys.—I: REGULAR PAPERS*, vol. 55, no. 8, Sep. pp.2433-2442, 2008.