

Speed Control of Induction Motors Utilizing Two-level Inverter with Optimal Controller

Dariush Nazarpour^{1*}, Rahim Fathi²

1- Department of Electrical Engineering, Urmia University, Urmia, Iran.

Email: d.nazarpour@urmia.ac.ir (Corresponding author)

2- Department of Electrical Engineering, Urmia University, Urmia, Iran.

Email: r.fathi@urmia.ac.ir

Received: January 2018

Revised: April 2018

Accepted: August 2018

ABSTRACT:

This paper presents indirect field-oriented control method for two-level inverter FED induction motor. This research paper offers a simple switching strategy to provide optimized output torque, speed regulation and also, less switching losses. In addition to enabling fast torque and speed response, this study also offers constant switching frequency. Conventional Hysteresis current controller has two main drawbacks; the first one is the variation of the switching frequency and the second one is more harmonics in motor currents. The aim of the present paper is to describe a novel switching technique, optimal controller, with the smallest possible tracking error and fixed switching frequency. Modeling and simulation of the proposed method are carried out using MATLAB/SIMULINK.

KEYWORDS: Hysteresis Current Controller HCC, Optimal Controller, Switching Pattern, Voltage Source Inverter VSI, Indirect Field Oriented Control IFOC, Induction Motor IM, Total Harmonic Distortion THD.

1. INTRODUCTION

Three phase voltage source inverter (VSI) is widely used in power electronics converters that are used in applications such as variable speed drives, active power filters. Two-level converter topology is simple to control. [1-2]

During the last decades, FOC for electrical drives has dominated high performance industrial application. Two control method of IM can be classed into direct and indirect Field-oriented control. [3-6]

FOC is based on the usage of a proper coordinate system that allows to control the torque and rotor flux independently. Indirect field oriented control IFOC of the IM has been commonly used in high performance applications because it has fast dynamic response and its simplicity. [7-8]

Different control switching strategies have been presented to control IM, but they differ in dynamic response and the switching frequency. [9-10]

HCC is a popular current controller in Drives. In this controller, three units are used independently, one for each phase.

It is obvious that there is no relation between switching function of the phases. This lack of coordination between the units, result in high number of switching and high losses. By using HCC, it is not

possible to control the switching frequency. As hysteresis band be narrower, the current becomes smother and its harmonic contents become smaller but the switching frequency becomes higher, this will generate higher switching losses. Several methods have been presented to minimize the dealing problems, these include modification of torque hysteresis controllers, application of space vector modulation SVM and using multilevel inverters.

In this paper, the IFOC is used for speed and torques control. An optimal controller is presented to produce switching function that is the decision about its switching on/off in fixed time interval. The aim of the present paper is to describe a novel switching signal generation technique that called optimal controller, which guarantees that required current of VSI.

Features of this controller are simplicity, quick response and lower switching number. In addition it has fixed decision time intervals. A comparison has been made with HCC and optimal controller.

1.1. Basic Principles of Indirect Torque Control

A digital rotor speed sensor is required for indirect FOC scheme. The rotor flux angle for FOC is obtained from the measured rotor speed and calculated slip angle

based on motor parameters. Since the rotor speed ω_r is directly measured, the rotor flux angle can be found by:

$$\theta_f = \int (\omega_r + \omega_{sl}) dt \quad (1)$$

Where, ω_{sl} is the angular slip frequency. In this control method, there is no need to identify the rotor flux linkage position. However, to control the slip frequency, the instantaneous rotor speed should be measured.

Fig.1 shows a block diagram for the indirect FOC. [3] Where λ_r^* reference rotor is flux and i_{ds}^*, i_{qs}^* are reference currents in stationary dq frame of stator.

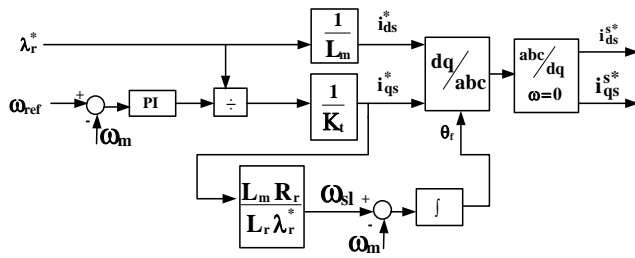

Fig. 1. The block diagram of IFOC.

2. MATHEMATICAL MODEL

Fig. 2 shows the main circuit topology of two level inverter in connection with three-phase induction motor. The phase voltages induction motor can be described as follow based on the assumption of Y connection of the stator windings.

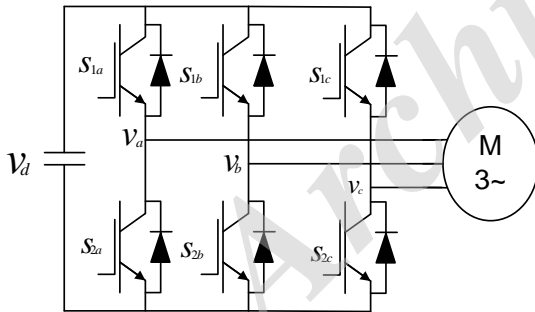

Fig.2. The basic scheme of three phase VSI.

$$\begin{bmatrix} v_a \\ v_b \\ v_c \end{bmatrix} = \begin{bmatrix} 2 & -1 & -1 \\ -1 & 2 & -1 \\ -1 & -1 & 2 \end{bmatrix} \begin{bmatrix} s_a \\ s_b \\ s_c \end{bmatrix} \quad (2)$$

Where in dq stationary frame can be written as follow:

$$v_{ds}^s = \frac{2}{3} v_d (s_a - 0.5s_b - 0.5s_c) \quad (3)$$

$$v_{qs}^s = \frac{\sqrt{3}}{3} v_d (s_b - s_c) \quad (4)$$

Where, s_a, s_b and s_c are switching functions and are

defined as:

$$s_i = \begin{cases} 1 & \text{if } s_{1i} \text{ is on} \\ 0 & \text{if } s_{2i} \text{ is on} \end{cases} \quad i = a, b, c \quad (5)$$

The machine modeling in the dq stationary frame are as follow: [11-12]

$$v_{ds}^s = R_s i_{ds}^s + L_s \frac{di_{ds}^s}{dt} + L_m \frac{di_{dr}^s}{dt} \quad (6)$$

$$v_{qs}^s = R_s i_{qs}^s + L_s \frac{di_{qs}^s}{dt} + L_m \frac{di_{qr}^s}{dt} \quad (7)$$

$$0 = R_r i_{dr}^s + \omega_r \lambda_{qr}^s + L_r \frac{di_{qr}^s}{dt} + L_m \frac{di_{ds}^s}{dt} \quad (8)$$

$$0 = R_r i_{qr}^s - \omega_r \lambda_{dr}^s + L_r \frac{di_{dr}^s}{dt} + L_m \frac{di_{qs}^s}{dt} \quad (9)$$

Where the rotor flux linkage in dq stationary frame are:

$$\lambda_{dr}^s = L_r i_{dr}^s + L_m i_{ds}^s \quad (10)$$

$$\lambda_{qr}^s = L_r i_{qr}^s + L_m i_{qs}^s \quad (11)$$

Based on the stator and rotor currents, the torque can be expressed as:

$$T_e = \frac{3p}{2} L_m (i_{ds}^s i_{dr}^s - i_{qs}^s i_{qr}^s) \quad (12)$$

$$\frac{d\omega_r}{dt} = \frac{1}{J} (T_e - T_L) \quad (13)$$

Where p: number of poles; J: moment of inertia (kg.m²). The state variables are chosen as follow:

$$\underline{x} = [i_{ds}^s \ i_{dr}^s \ i_{qs}^s \ i_{qr}^s]^T \quad (14)$$

From equation 6-11, we have equations of state variables as follow:

$$\dot{\underline{x}} = A \underline{x} + B u \quad (15)$$

And:

$$A = \frac{L_r}{L_r L_s - L_m^2} \begin{bmatrix} -R_s & + \frac{L_m R_r}{L_r} & \frac{L_m^2}{L_r} \omega_r & L_m \omega_r \\ +R_s & - \frac{L_s R_r}{L_m} & -L_s \omega_r & \frac{L_r L_s}{L_m} \omega_r \\ - \frac{L_m^2}{L_r} \omega_r & -L_m \omega_r & -R_s & + \frac{L_m R_r}{L_r} \\ +L_s \omega_r & \frac{L_r L_s}{L_m} \omega_r & +R_s & - \frac{L_s R_r}{L_m} \end{bmatrix}$$

$$B = \frac{L_r}{L_r L_s - L_m^2} V_d \begin{bmatrix} \frac{2}{3} & -\frac{1}{3} & -\frac{1}{3} \\ \frac{2}{3} & -\frac{1}{3} & -\frac{1}{3} \\ 0 & \frac{\sqrt{3}}{3} & -\frac{\sqrt{3}}{3} \\ 0 & \frac{\sqrt{3}}{3} & -\frac{\sqrt{3}}{3} \end{bmatrix}$$

$$u = [s_a \ s_b \ s_c]^T \quad (16)$$

Equations 17 to 19 shows the necessary procedure for calculation of switching signals by this proposed method. In this equations, stator and rotor current in stationary dq frame are state variables that are shown as $\underline{x}(k+1)$. Obviously the state variables in (k+1) time interval are function of state variables in previous time interval, $\underline{x}(k)$ and switching function $\underline{s}(k)$.

$$\begin{aligned} \dot{\underline{x}}(t) &= f(\underline{x}(t), \underline{s}(t)) \\ \underline{x}(t + \Delta t) &\cong \underline{x}(t) + f(\underline{x}(t), \underline{s}(t))\Delta t \\ t &= k\Delta t \end{aligned} \tag{17}$$

$$\begin{aligned} \underline{x}((k+1)\Delta t) &\cong \underline{x}(k\Delta t) + f(\underline{x}(k\Delta t), \underline{s}(k\Delta t))\Delta t \\ \text{By defining } \underline{x}((k) &= \underline{x}(k\Delta t) \quad , \quad \Delta t = T_s \end{aligned} \tag{18}$$

$$\underline{x}((k+1) \cong \underline{x}(k) + f(\underline{x}(k), \underline{s}(k)) T_s \tag{19}$$

Where, T_s is the sampling time interval. Equations 20 to 23 show the mentioned procedure for machine equations.

$$x_1(k+1) = x_1(k) + T_s \dot{x}_1 \tag{20}$$

$$x_2(k+1) = x_2(k) + T_s \dot{x}_2 \tag{21}$$

$$x_3(k+1) = x_3(k) + T_s \dot{x}_3 \tag{22}$$

$$x_4(k+1) = x_4(k) + T_s \dot{x}_4 \tag{23}$$

For generating the switching pattern, we can use well known Hysteresis controller. Each VSI has three legs, one for phase. Each phase VSI consists of two switches (with an anti-parallel diode). The HCC has higher switching frequency and switching losses but better results with lower THD of currents by decreasing hysteresis band. In addition, it is not possible to control the switching frequency. Due to the lack of coordination among individual HCC of three phases, very high switching frequency may happen. This will increase the switching losses. In this paper, a new optimal controller is used which modifies the variable frequency method into constant sampling method with an average switching frequency less than the sampling frequency that causes less losses.

Optimal controller is a feedback controller strategy that is designed to control the switching function. Fig.3 shows principle of tracking problem by this controller and block diagram of control system is shown in Fig.4.

At first the reference actual current and motor speed are sampled with fixed sampling frequency. Then discrete model of system is applied. Switching signals is derived by minimizing the square tracking error between the reference and actual state variables i.e. minimizing H.

Equations 25 shows an objective function H, switching patterns should be chosen in a way that objective function be minimized. In this equation

$\underline{y}(k+1)$ and \underline{ref} are vectors that show discrete of two state variables and two reference as follow:

$$\underline{y}(k+1) = [x_1(k+1) \quad x_3(k+1)]^T \tag{24}$$

$$\underline{ref} = [i_{ds}^* \quad i_{qs}^*]^T$$

$$H = \|\underline{y}(k+1) - \underline{ref}\|^2 \tag{25}$$

$$\|\underline{x}\|^2 = \underline{x}^T \cdot \underline{x}$$

Optimal controller is a feedback controller strategy that is designed to control the switching patterns in a way that output currents of converter can track the reference at every sampling interval. Any deviation of the reference is corrected within one sampling interval, T_s .

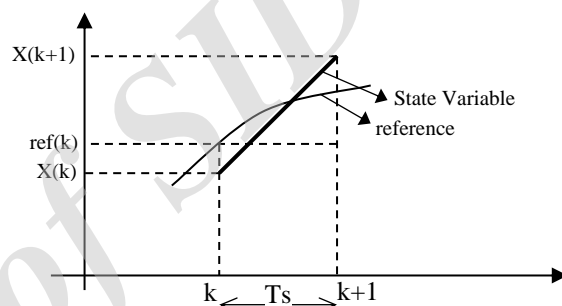

Fig.3. Principle of tracking problem by optimal controller.

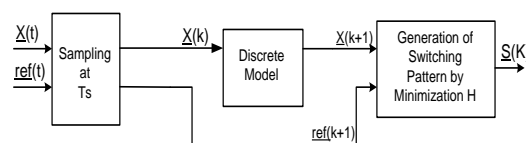

Fig. 4. The Block diagram of switching pattern generation method.

We have three controlling signals, the S_a , S_b and S_c , so we have 2^3 combination of input signals. Now by checking the objective function for each state, optimal controller will be derived and will applied to the switches in a way that selected state is the best at minimizing the square error between reference and state variables.

The Optimal Controller block diagram can be observed in Fig.5.

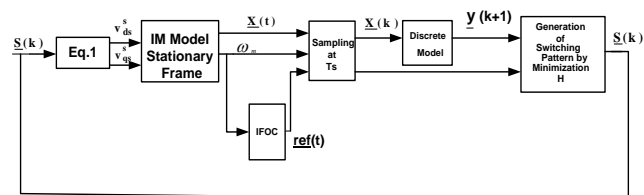

Fig.5 The block diagram of Optimal Controller.

3. SIMULATION RESULTS

In this section simulation results are presented in order to verify the performance of new optimal control method in comparison to traditional strategy i.e. the HCC method.

Since in the HCC method, it is not possible to have a fixed switching frequency, by modifying hysteresis band we can obtain same switching numbers in two methods i.e. the HCC and optimal controller.

The motor data and parameters have been given in Table 1.

The first simulation presents the steady state behavior for each two methods when motor is operated at 150 rad/s with load torque of 200 N.M. The voltage, stator current, rotor speed and torque are shown in Fig6.

The average switching frequency is equal to 5 KHZ.

Table1. The induction motor parameters.

Rated power	50 hp
Voltage	460 volt
Number of poles	4
Stator Resistance R_s	0.087 Ω
Rotor Resistance R_r	0.228 Ω
Stator self-Inductance	$0.8 \cdot 10^{-3}$ H
Rotor self-Inductance	$0.8 \cdot 10^{-3}$ H
Multi Inductance	$34.7 \cdot 10^3$ H
Total Inertia	1.662 kg.m ²
Rater rotor flux	0.83 wb

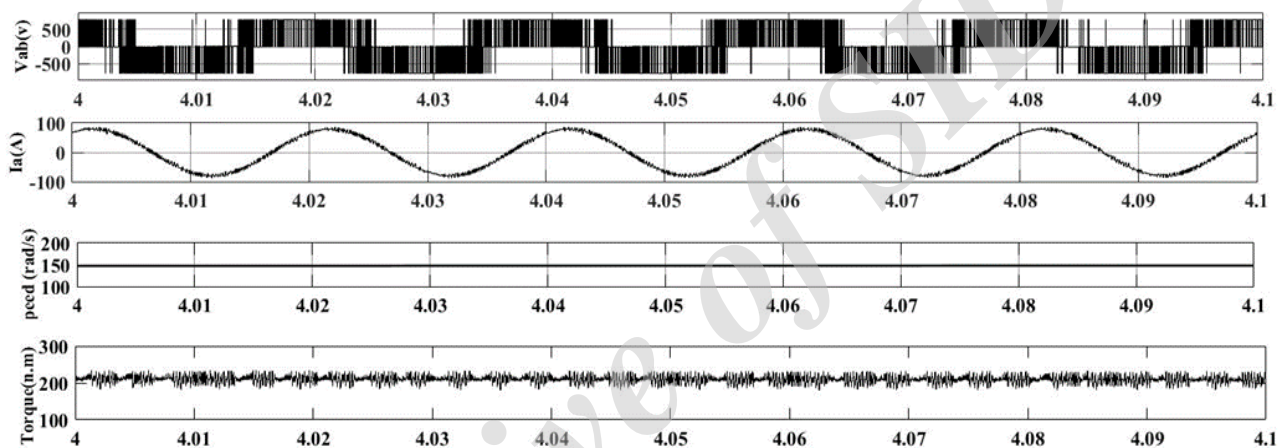

a) HCC

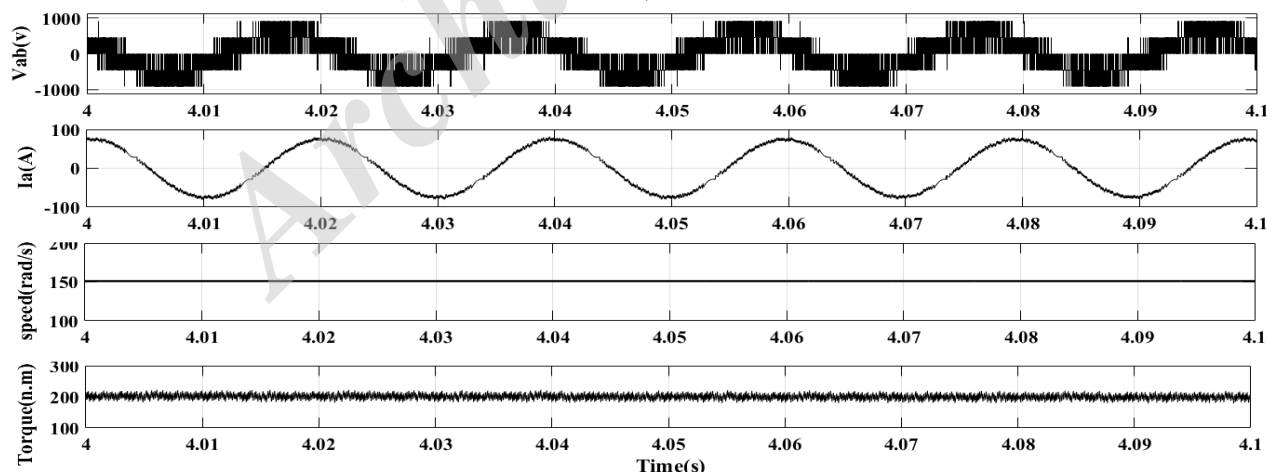

b) Optimal Controller

Fig.6. The steady state behavior of each control strategy.

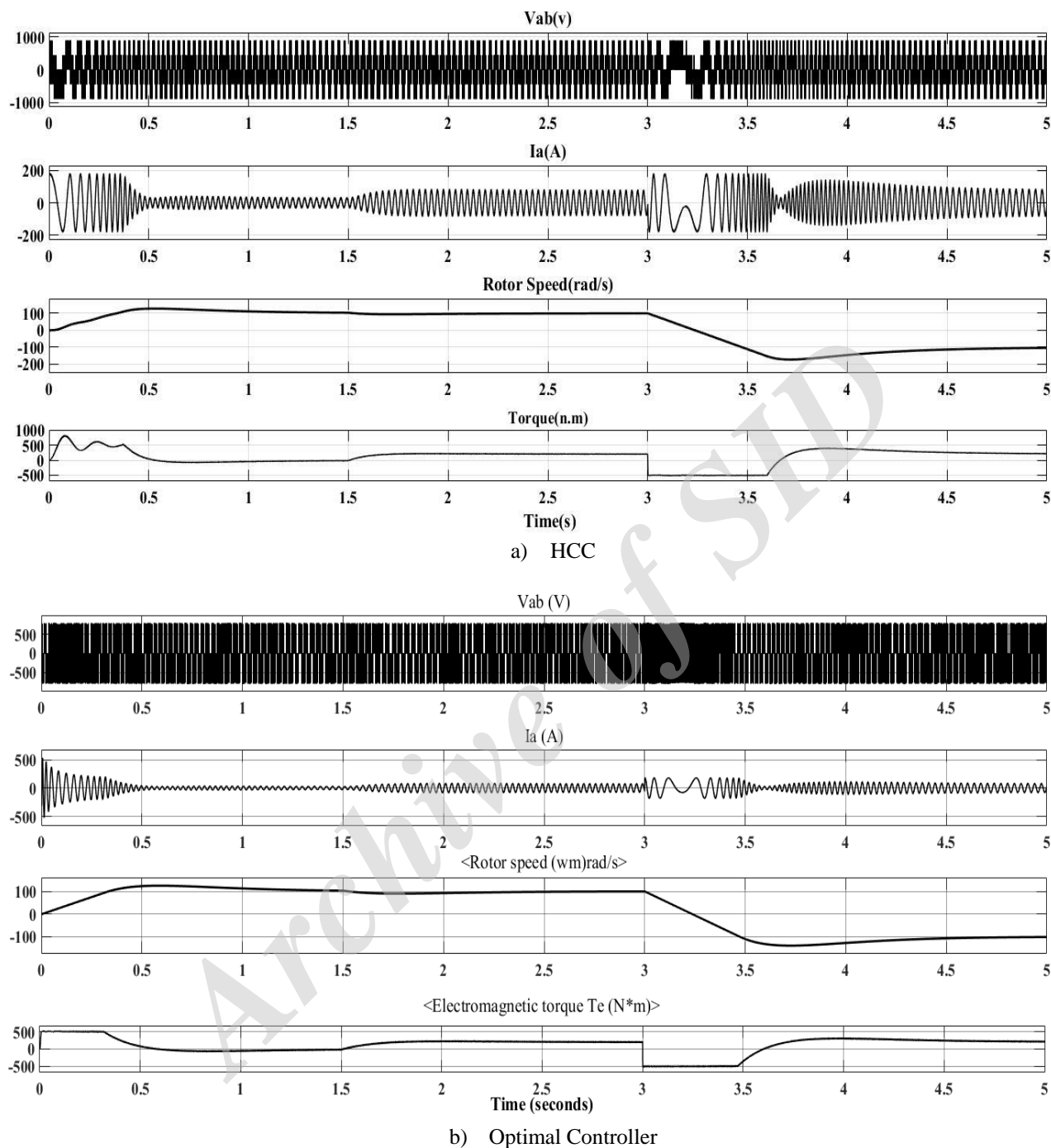

Fig.7. The transient behavior of each control strategy.

The high performance of optimal controller is shown in Fig.6-b. In this structure, very low current distortion is obtained (THD=4%), where, in HCC controller the THD result is 8%.

. Due to the hysteresis comparators, torque contains a lot of noise, this fact is a typical feature of this controller.

The second simulation considers a controlled starting from zero to rotor speed (100 rad/s) and a speed reverse operation at time $t=3s$. The load torque 200N.M is applied at $t=1.5s$. In fig.7 speed, torque, voltage and current of stator are shown. The optimal controller has quick response in comparison with HCC method.

4. CONCLUSION

A new optimal controller is presented for generating of switching pattern of VSI. The proposed optimal controller is a good operating technique to generate the gating control signals for VSI. The indirect field-oriented control method is used for controlling speed and torque. The results of simulation confirm the efficiency of optimal controller. It has fast response in tracking reference currents by actual currents of VSI. In addition to the lower ripple of injection currents, it has fixed decision time intervals. This results of this method is limiting the maximum switching frequency on a fixed value. It is obvious that the proposed strategy can easily generate any desired reference current for VSIs for different applications.

The salient of this controller are simplicity, quick response, lower number of switching and THD. The THD of motor current diminishes from 16% to 4% while reducing the switching losses. In addition, it has fixed frequency switching, but HCC method has not constant switching frequency.

REFERENCES

- [1] Onederra, Oier, et al. "Three-Phase VSI Optimal Switching Loss Reduction Using Variable Switching Frequency." *IEEE Transactions on Power Electronics* 32.8, pp. 6570-6576, 2017.
- [2] M. Tarafdar Haque, R. Fathi, "A Novel Optimal Controller for Tracking of Reference Compensating Currents of Parallel Active Filter," *EPE power electronic, Pelincec2005, paper ID: 66*, Warsaw, October 2005.
- [3] Wu, Bin, and Mehdi Narimani. "High-power Converters and Ac Drives", *John Wiley & Sons*, 2017.
- [4] Hasse, "Control of Electrical Drives", Berlin: Springer-Verlag, 1996.
- [5] Kennel, R., et al. "High Performance Speed Control Methods for Electrical Machines: An Assessment." *Industrial Technology (ICIT), 2010 IEEE International Conference on. IEEE*, 2010.
- [6] Takahashi, Isao, and Toshihiko Noguchi. "A New Quick-Response and High-Efficiency Control Strategy of an Induction Motor." *IEEE Transactions on Industry applications* 5, pp. 820-827, 1986.
- [7] Blaschke, Felix. "The Principle of Field Orientation as Applied to The New Trans Vector Closed-Loop System for Rotating-Field Machines." *Siemens review* 34.3, pp. 217-220, 1972.
- [8] Zaky, Mohamed S., and Mohamed K. Metwaly. "Sensorless Torque/Speed Control of Induction Motor Drives at Zero and Low Frequencies with Stator and Rotor Resistance Estimations." *IEEE Journal of Emerging and Selected Topics in Power Electronics* 4.4, pp. 1416-1429, 2016.
- [9] Marei, M. I., E. F. El-Saadany, and M. M. A. Salama. "A New Contribution into Performance of Active Power Filter Utilizing SVM Based HCC Technique." *Power Engineering Society Summer Meeting, 2002 IEEE*. Vol. 2. IEEE, 2002.
- [10] Nabae, Akira, Satoshi Ogasawara, and Hirofumi Akagi. "A Novel Control Scheme for Current-Controlled PWM Inverters." *IEEE Transactions on Industry Applications* 4, pp. 697-701, 1986.
- [11] Krause, Paul C., Oleg Wasynczuk, and Scott D. Sudhoff. "Analysis of Electrical Machines and Drive Systems." *IEEE Wiley*, 2002.