



## Stage specialization for design and analysis of flotation circuits

V. Radmehr, S.Z. Shafaei\*, M. Noaparast and H. Abdollahi

*School of Mining Engineering, College of Engineering, University of Tehran, Tehran, Iran*

Received 14 February 2018; received in revised form 8 July 2018; accepted 8 July 2018

### Keywords

*Froth Flotation*  
*Circuit Design*  
*Specialization*  
*Lead Flotation Plant*  
*Primary and Secondary Concentrations*

### Abstract

This paper presents a new approach for flotation circuit design. Initially, it was proven numerically and analytically that in order to achieve the highest recovery in different circuit configurations, the best equipment must be placed at the beginning stage of the flotation circuits. The size of the entering particles and the types of streams including pulp and froth were considered as the basis for specialization of the flotation processes. In the new approach, the flotation process plays as the two functions of primary and secondary concentrations. The proposed approach was applied to a lead flotation circuit of a lead-zinc flotation plant. The results obtained showed that in most traditional-oriented circuits, a large part of the streams containing valuable metals were returned to the rougher stage, which, in turn, reduced the efficiency and caused perturbation. In the new approach, providing more control over unit operations in the circuit could provide a higher performance. In addition, in cases where zinc minerals are liberated from their gangue in coarse size, the new approach, by generating coarse-grained tailing, can prevent excessive grinding of zinc minerals in the feed into the zinc flotation circuit.

### 1. Introduction

A variety of equipment such as screen, hydrocyclone, heavy media cyclone, and flotation cell are used in mineral separation circuits [1]. By decreasing the grade and difficulty of valuable particle separation, more control over the operating conditions of each separation unit plays an important role in the flotation process [2, 3]. Therefore, each unit can properly act in accordance with its design situation. In separation units, the mineral flow is introduced to the unit, and is affected by gravity, surface, electrical forces etc., which are functions of mineral properties such as the size, density, and surface conditions [4].

Flotation is widely employed to process the sulfide, oxide, and coal minerals. Due to the lack of a proper separation at one stage, several flotation banks are often required under the name of flotation circuit in order to achieve an optimal efficiency [5, 6]. In the last few years, there has been a growing interest in separation circuit

optimization using modeling, simulation, search strategies, etc. [7-10]. Most of these circuit optimization techniques utilize a super-structure containing all the possible layouts for displaying the circuit design alternatives. Then mathematical modeling and a search algorithm are implemented to find the optimal circuit based on one or more objective functions. Different search strategies such as genetic algorithm, integer linear programming, and mixed integer have been used to find the optimal design of flotation circuit [11-14].

However, to the author's best knowledge, very few publications are available in the literature that addresses the issue of specialization of the separation stages. The major drawback of the optimization approaches is that the results of these methods are largely complex and impractical. Search algorithms are highly dependent on the input data and the accuracy of process models [15]. The main objective of this research work is

✉ Corresponding author: [zshafaei@ut.ac.ir](mailto:zshafaei@ut.ac.ir) (S.Z. Shafaei).

to propose an approach for the specialization of the separation function for different stages of the flotation circuit based on the feed particle size and the proposed two-stage separation circuits. In this work, for the first time, it was proved numerically and analytically that in a flotation circuit with any arrangement, the highest recovery should be assigned to the rougher stage. Therefore, the best equipment must be used at the beginning stage of separation. By separating the feed particles into two fine and coarse fractions, suitable equipment could be employed for their processing. The remainder of the paper is organized in various sections named as recovery allocation, function specialization, solution of a case study, and results.

## 2. Methodology

### 2.1. Recovery allocation

Different units such as rougher, scavenger, and cleaner are normally used in flotation circuits. One of the indicators used for evaluating the efficiency of these units is the ratio of the mass flow rate of the valuable metals in concentrate by that of the feed, which is called recovery (R). Placing a number of separation units next to each other, a circuit is obtained, which has an overall recovery and is accordingly dependent on the recovery of each stage. As a result, the recovery of each stage affects the overall recovery of the circuit, and its allocation is very significant. In this section, the most important stage through the actual allocation of recovery for four stages of flotation circuits with the assumption of available recovery values of 60%, 50%, 40%, and 30% have been investigated.

Some common circuit configuration for a 4-stage flotation plant are shown in Table 1 [4, 16]. F, C, and T are the tonnages of products with a specific characteristic in the feed, concentrate, and tailings, respectively. R, C, and S are symbols of the stages rougher, cleaner, and scavenger, respectively. In addition, the symbols C<sub>3</sub> and S<sub>2</sub> were used for simplicity for the three stages of cleaner and the two stages of scavenger. For all configurations, the recovery numbering is started from the left. Therefore, the calculated recovery functions are in a specific order. In Table 1, the R-C<sub>3</sub>, R-S<sub>3</sub>, R-S-C<sub>2</sub>, and R-S<sub>2</sub>-C circuits are counter-current. In these circuits, the pulp and froth streams move in the opposite direction. The R-S-CS-C and R-S-SC-C circuits are not counter-currents due to the cleaner-scavenger or scavenger-cleaner units. These circuits can be considered as circuits with a side unit. The numerical values of the total circuit

recovery for a variety of recovery allocation are presented in Table 2.

The highlighted numbers represent the highest numerical values of the circuit recovery function for the different stage recoveries. The maximum recoveries for the R-C<sub>3</sub> and R-S<sub>3</sub> circuits are 17.65% and 81.88%, respectively. As a result, by decreasing the cleaner stage number and increasing the scavenger stage number, the total circuit recovery increases. In addition, in the counter-current circuits, without side-units and cross-flow streams, there is merely one state where the total recovery of the circuit has its maximum value. These circuits include R-C<sub>3</sub>, R-S<sub>3</sub>, R-S-C<sub>2</sub>, and R-S<sub>2</sub>-C with the overall recoveries of 17.65, 85.81, 59.42, and 37.97%, respectively. However, in the circuits with cleaner-scavenger and scavenger-cleaner units, the conditions are different. Although in all of these circuits the highest recovery is assigned to the rougher stage, the maximum recovery in the cleaner-scavenger or scavenger-cleaner stages can also lead to maximize the circuit overall recovery. The total recovery order for different configurations shown in Table 2 is as follows:

$$R-S_3 > R-S_2-C > R-C-S_2 > R-C-S-CS > R-C_2-S > R-C_3 \quad (1)$$

Equation (1) shows that the maximum circuit grade and recovery have inverse trends.

Table 2 shows that the maximum recovery of the circuit occurs when the highest recovery is assigned to the rougher stage. As a result, for the highest recovery, the best equipment must be placed at the beginning of the circuit. The proof of the calculated optimal allocation for the global optimal type is shown for the R-C<sub>3</sub> circuit, with the feed to stage one. By calculations, the order of optimal allocation in the form of R<sub>1</sub>, R<sub>2</sub>, R<sub>3</sub>, and R<sub>4</sub> was obtained. This means that the first step must be firstly allocated, and then stages two, three, and four should be run. Assume that all R<sub>i</sub> values are non-zero and that R<sub>1</sub> > R<sub>4</sub>. Consider that:

$$R_T(R_4, R_3, R_2, R_1) > R_T(R_1, R_3, R_2, R_4) \quad (2)$$

It will be shown that how this leads to a contradiction, and to prove it, the first stage must get a higher recovery value than stage four, according to Equation (2). In which  $\bar{R}$  is equal to  $1-R$ . By removing the numerator of the fraction in Equation (3) and multiply the denominator in the numerator of the opposite fraction, Equation (4) is obtained.

$$\frac{R_1 R_2 R_3 R_4}{1 - R_4 \bar{R}_3 - R_3 \bar{R}_2 - R_2 \bar{R}_1 + R_4 \bar{R}_3 R_2 \bar{R}_1} > \frac{R_1 R_2 R_3 R_4}{1 - R_1 \bar{R}_3 - R_3 \bar{R}_2 - R_2 \bar{R}_4 + R_1 \bar{R}_3 R_2 \bar{R}_4} \quad (3)$$

$$1 - R_1 \bar{R}_3 - R_3 \bar{R}_2 - R_2 \bar{R}_4 + R_1 \bar{R}_3 R_2 \bar{R}_4 > 1 - R_4 \bar{R}_3 - R_3 \bar{R}_2 - R_2 \bar{R}_1 + R_4 \bar{R}_3 R_2 \bar{R}_1 \quad (4)$$

**Table 1. Recovery function and some conventional configurations for 4-stage flotation circuit.**

	Circuit	Circuit equation (Overall recovery, $R_T$ )
R-C <sub>3</sub>		$\frac{R_1 R_2 R_3 R_4}{1 - R_1(1 - R_2) - R_2(1 - R_3) - R_3(1 - R_4) + R_1 R_3(1 - R_2)(1 - R_4)}$
R-S <sub>3</sub>		$\frac{R_4(1 - R_1(1 - R_2) - R_2(1 - R_3))}{1 - R_1(1 - R_2) - R_2(1 - R_3) - R_3(1 - R_4) + R_1 R_3(1 - R_2)(1 - R_4)}$
R-S-C <sub>2</sub>		$\frac{R_2 R_3 R_4}{1 - R_1(1 - R_2) - R_2(1 - R_3) - R_3(1 - R_4) + R_1 R_3(1 - R_2)(1 - R_4)}$
R-S <sub>2</sub> -C		$\frac{R_3 R_4(1 - R_1(1 - R_2))}{1 - R_1(1 - R_2) - R_2(1 - R_3) - R_3(1 - R_4) + R_1 R_3(1 - R_2)(1 - R_4)}$
R-S-C-SC		$\frac{R_2 R_4 + R_1(1 - R_2) R_3 R_4}{1 - R_2(1 - R_4) - R_1 R_3(1 - R_2)(1 - R_4)}$
R-S-C-CS		$\frac{R_2 R_4}{1 - R_1(1 - R_2) - R_3(1 - R_4) + R_1 R_3(1 - R_2)(1 - R_4)}$

**Table 2. Recovery allocation and circuit recovery for different configurations (maximum recovery in each circuit is bold).**

Stage recovery (%)				Circuit recovery (%)					
R <sub>1</sub>	R <sub>2</sub>	R <sub>3</sub>	R <sub>4</sub>	R-C <sub>3</sub>	R-S <sub>3</sub>	R-C <sub>2</sub> -S	R-C-S <sub>2</sub>	R-S-C-SC	R-C-S-CS
30	40	50	60	7.89	<b>81.85</b>	26.32	53.95	36.57	36.59
30	40	60	50	8.70	79.71	28.99	<b>59.42</b>	34.05	34.84
30	50	40	60	8.70	79.71	28.99	49.28	43.30	42.02
30	50	60	40	10.47	75.58	34.88	59.30	36.53	36.76
30	60	40	50	10.47	75.58	34.88	51.16	<b>47.93</b>	<b>42.61</b>
30	60	50	40	11.39	73.42	<b>37.97</b>	55.70	43.71	38.96
40	30	50	60	8.45	80.28	21.13	50.70	32.04	31.25
40	30	60	50	9.37	78.13	23.44	56.25	30.55	29.76
40	50	30	60	10.17	76.27	25.42	40.68	43.30	<b>42.61</b>
40	50	60	30	13.64	68.18	34.09	54.55	32.86	32.33
40	60	30	50	12.24	71.43	30.61	42.86	<b>47.93</b>	42.02
40	60	50	30	14.63	65.85	36.59	51.22	38.93	32.97
50	30	40	60	9.84	77.05	19.67	42.62	32.04	32.97
50	30	60	40	12.16	71.62	24.32	52.70	29.39	28.85
50	40	30	60	10.71	75	21.43	37.50	36.57	38.96
50	40	60	30	14.63	65.85	29.27	51.22	29.29	29.56
50	60	30	40	15.25	64.61	30.51	40.68	43.71	36.59
50	60	40	30	16.67	61.11	33.33	44.44	38.93	31.28
60	30	40	50	12.68	70.42	21.13	40.85	30.55	32.33
60	30	50	40	14.06	67.19	23.44	45.31	29.39	29.56
60	40	30	50	13.64	68.18	22.73	36.36	34.05	36.76
60	40	50	30	16.67	61.11	27.78	44.44	29.29	28.85
60	50	30	40	16.07	62.50	26.79	37.50	36.53	34.84
60	50	40	30	<b>17.65</b>	58.82	29.41	41.18	32.86	29.76

Combining and substitution  $1 - R_4$  for  $\bar{R}_4$  and  $1 - R_1$  for  $\bar{R}_1$  in Equation (4) give the following result:

$$R_2(R_4 - R_1) > R_2\bar{R}_3(R_4 - R_1) - \bar{R}_3(R_4 - R_1) \quad (5)$$

Simplifying Equation (5):

$$(R_2 + \bar{R}_3 - R_2\bar{R}_3)(R_4 - R_1) > 0 \quad (6)$$

A further substitution of  $R_2(1 - R_3)$  for  $R_2\bar{R}_3$  gives:

$$(R_2R_3 + \bar{R}_3)(R_4 - R_1) > 0 \quad (7)$$

Given that in Equation (7), the first expression is positive in the parenthesis, it is obtained by dividing it.

$$R_4 - R_1 > 0 \text{ or } R_4 > R_1 \quad (8)$$

Albeit that is a contradiction, and as a result, when  $R_1 > R_2$ ,  $R_T(R_1, R_2, R_3, R_4)$  is higher than  $R_T(R_4, R_2, R_3, R_1)$ , it points to this fact that the highest value of the recovery must be allocated to the first stage. Similarly, it can be concluded that the second stage must be allocated before the other stages. It should be noted that when changing both  $R_i$ , no restrictions are placed on the other  $R_i$ . This

means that the optimal allocation order, regardless of the available values for  $R_1, R_2, R_3$ , and  $R_4$ , is maintained. Similar proofs can be developed for other circuits in Table 1.

## 2.2. Function specialization

In the traditional approach, the separation circuits have two or three stages including rougher, scavenger, and cleaner. Investigation of the flow sheets used for various types of minerals including sulfide ores, coal, and even industrial minerals shows that the conventional layout of counter-current separation circuits is employed for processing all types of minerals. The flotation section of the copper and barite processing plants is shown in Figure 1 [17].

In such circuits, after the grinding phase, the feed with a certain solid percent enters the flotation circuit. The flotation circuit for copper processing (Figure 1a) is R-S-C<sub>2</sub>, which contains four cells per unit as the rougher stage, two cells as the scavenger stage, one cell as the cleaner, and one cell as the re-cleaner stages. The barite flotation circuit (Figure 1b) has one-stage rougher and two-stage cleaner and shows in the form of R-C<sub>2</sub>. These circuits are counter-current. As shown, for the separation of various types of minerals, especially sulfide ores, usually three or four stages of separation have been used, due to the high

separation factor of these minerals [18]. In such a situation, while maintaining the existing structure, by specializing the tasks of each stage, using the appropriate equipment in each part, and mastering the operating conditions as well, it is possible to control the separation units as much as possible. In this section, the following points are considered to design a new separation circuit:

1. Split the feed into the flotation circuit based on the particle size.
  - 2- Concentration in two stages including pre-concentration and final concentration.
  - 3- Coarse and fine particles processing in different unit operations and conditions.
  - 4- Usage of Conventional circuits in the secondary concentration stage for processing the pre-concentrated stream.
- The input feed contains a variety of minerals with different particle size fractions. By separating and specializing the separation of these particles in

particular equipment, except to achieve the desired quality of the product, the efficiency of the equipment is going to increase, and the energy required for grinding will accordingly decrease as well. The feed can be split based on a special size such as 250  $\mu\text{m}$  in flotation into two coarse and fine fractions, and then appropriate equipment based on that size can be applied. In order to separate the feed in terms of grain size, it is possible to use classifiers such as hydrocyclone, mechanical classifier or screen. Particles in small size are transferred to a mechanical flotation bank, while particles in coarse size are processed in special equipment such as HydroFloat. In the past, unit-cell had been employed in the mill output to recovery of the valuable particles and produce the concentrate with a desired grade [17]. Figure 2 presents a sample flowsheet of lead-zinc minerals processing containing the unit-cell.

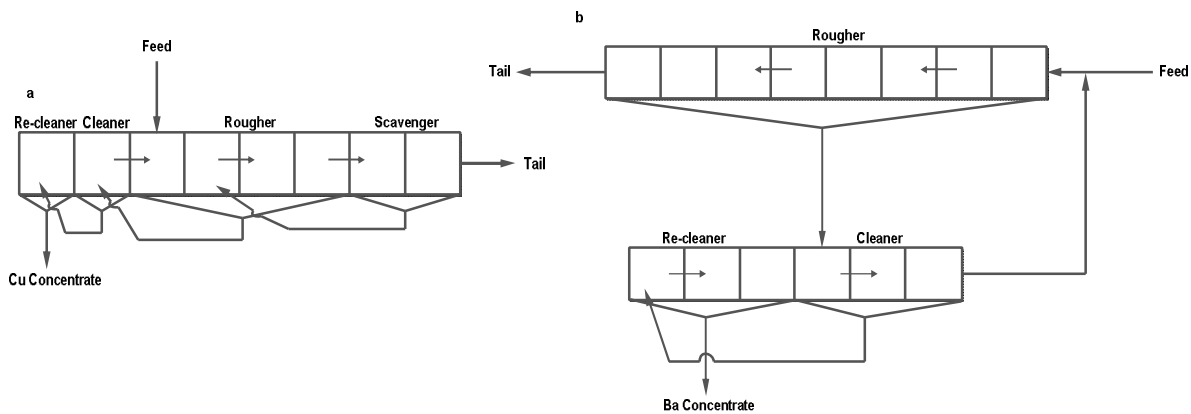

Figure 1. Types of flotation circuits: a) copper and b) barite [17].

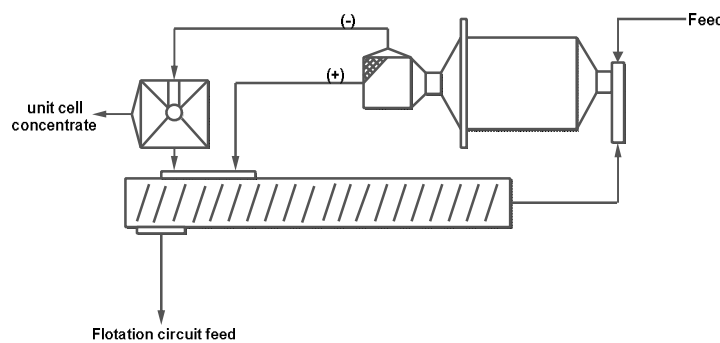

Figure 2. Unit-cell for flotation of lead minerals in coarse particle size fraction [17].

The existence of this unit operation, in addition to recovering the valuable particles liberated in the coarse size, prevents excessive grinding of these particles in the mill. As a result, energy consumption is reduced in the grinding section, which results from the return of materials from the classification units. Today, flotation equipment

for processing of particles in the coarse size is often employed for the hydrocyclone underflow stream. Recent studies have shown that installing this equipment at the plant would greatly reduce energy consumption [19-23]. Usually valuable minerals are softer and have higher densities than the host rock. Therefore,

they accumulate in the circulating load in the grinding circuit. This can lead to an excessive comminution of valuable minerals before it reaches the hydrocyclone, which results in the recovery loss in the flotation circuit. In comparison, the flotation conditions in the hydrocyclone underflow are much better than the overflow (flotation feed), which is due to the presence of fast floating liberated particles in this stream. However, it should be noted that the surface of the particles is less oxidized in the hydrocyclone underflow, and the slimes in this section are less. As a result, the installation of these equipment in the grinding circuit would significantly increase the plant efficiency. In the new approach, the goal of the initial concentration (pre-concentration) is to achieve the maximum recovery of valuable particles and the lowest possible particle loss in the tailing of this stage. In this stage, the grade of the product is not a very key factor, and the main focus is on maximizing the process recovery. The step-by-step flowsheet of this stage is shown in Figure 3. In the primary stage, the particles are separated into coarse and fine size fractions by classifiers such as screen or hydrocyclone. Coarse-sized

particles are recovered in special equipment such as HydroFloat or flash cell, and fine-sized particles go to the mechanical flotation cells. The concentrates of these two parts with the maximum recovery and with a low grade are transferred to the secondary concentration circuit in order to achieve the desired grade/quality. The schematic two-stage separation unit is presented in Figure 4. In the secondary separation stage, various types of configurations for the flotation circuit can be employed. Here, the rougher-scavenger-cleaner arrangement is selected to process the froth from the primary concentration stage. In a common view, the flotation circuit is used to separate the valuable and gangue minerals existing in the pulp flow. As a result, in the scavenger stage, there is a need for large enough equipment to process and return the middling materials to the rougher or cleaner stages. In the new approach, however, the primary concentration stage by receiving coarse-sized particles will reduce the consumption of energy in the grinding circuit, while the low density and tonnage in the secondary concentration stage will reduce the perturbation, control more operational parameters, and probably increase in the recovery.

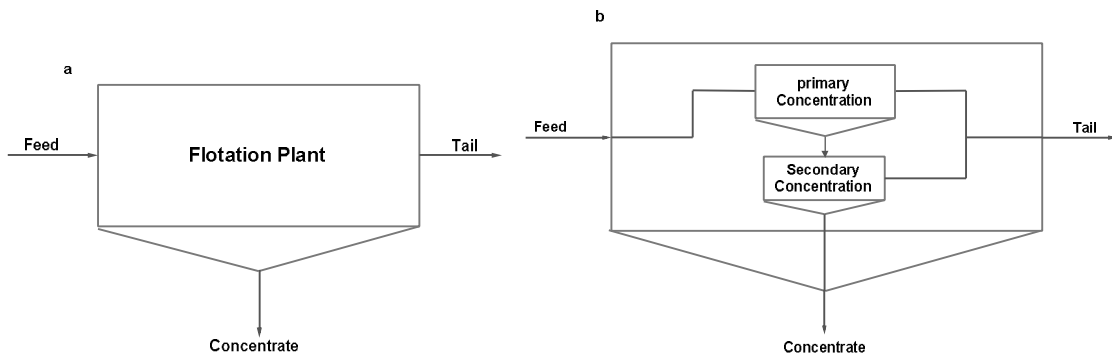

Figure 3. Design of the separation circuit a) flotation plant b) separation by primary and secondary concentration units.

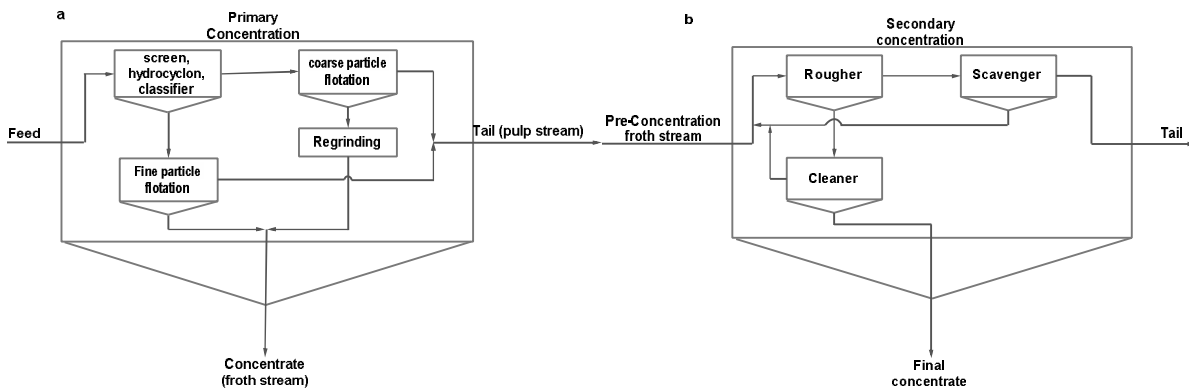

Figure 4. Details of separation units in a) primary concentration and b) secondary concentration.

### 3. Case study: Bama lead and zinc flotation plant

The lead flotation circuit of the Bama lead-zinc processing plant is in accordance with Figure 5 with a feed grade of 2.5% Pb and a feed rate of 50 t/h. The recovery of this circuit is 75% with a grade of 67% Pb in concentrate. The mass balance of input and output is also shown in Figure 5. For a better evaluation, the information about 80% passing size and the percentage of solids in the grinding section is shown in Figure 6. In this

circuit, according to the plant conditions, it was not possible to take the sample from the hydrocyclone feed. Figure 6 shows that the feed enters the open circuit of a rod mill, and the product with the output of the ball mill enters the hydrocyclone. Hydrocyclone underflow is further ground in a closed circuit with a ball mill. Hydrocyclone overflow as the output of the grinding circuit with 40% solid and  $d_{80}=90$  microns enters the flotation section.

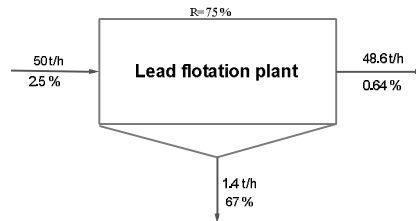

Figure 5. Lead section of the Zn-Pb flotation plant.

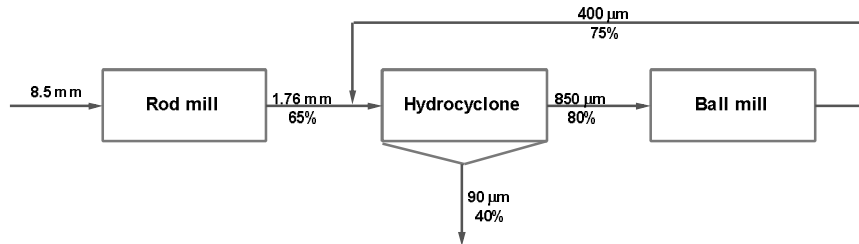

Figure 6. Grinding and classification sections of the lead processing plant.

The following two traditional and new approaches are used for the re-design and analysis of this circuit.

#### 3.1. Traditional approach

In this method, the grinding of the particles is continued to achieve the appropriate degree of liberation. Typically, in the grinding section, the particles are ground to reach about 80% of particles to -100 or -150 microns as the flotation feed. Here, the rougher-scavenger-cleaner-

recleaner configuration has been applied in the flotation section. By sampling from the input and output streams of each stage in the lead flotation circuit, the recoveries were estimated, which were about 75, 66, 58, and 44% in banks, respectively. The flotation plant along with the streams containing lead is shown in Figure 7. The volume of the cells in the rougher, scavenger, cleaner, and recleaner stages are 6, 9, 4, and 2 m<sup>3</sup>, respectively.

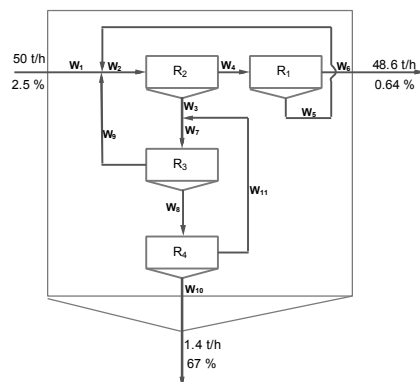

Figure 7. The lead flotation circuit designed with traditional approach.

According to calculations in Section 2, it was shown that the highest amount of recovery and the best equipment had to be allocated to the first stage. Since this point is not observed in the flotation circuit of this plant, in order to achieve the desired recovery, it is necessary to return a high amount of middling from the scavenger to the rougher stage. This, in turn, causes a disturbance in the function of the rougher stage and decreases the grade of the concentrate, which consequently enters the cleaner stage. As a result, in order to achieve the desired grade, it is necessary to increase the number of cleaner stages. The mass balance was calculated based on the

recovery of each stage, which is presented in Table 3. The mass of metal in the fresh feed is 1.25 and at the entrance to the rougher bank is 3.74 t/h. This means that the weight of the metal entering the bank is approximately three times the weight of the metal entering the circuit. If the rougher stage for this circuit is designed only to meet the tonnage of 50 t/h with a grade of 2.5%, it will be associated with a lot of difficulties since increasing the amount of metal in the input, in addition to the design parameters, will affect the operating parameters such as the type and amount of chemicals, and pulp density.

**Table 3. The mass ratio and stream metal content in conventional approach.**

Stream i	$w_i / w_1$	Metal content
$w_1$	1	1.25
$w_2$	2.99	3.74
$w_3$	1.97	2.47
$w_4$	1.028	1.27
$w_5$	0.76	0.95
$w_6$	0.25	0.32
$w_7$	2.92	3.65
$w_8$	1.70	2.12
$w_9$	1.23	1.53
$w_{10}$	0.75	0.93
$w_{11}$	0.95	1.19
<b>Verification:</b> $w_1 = w_{10} + w_6$		

### 3.2. New approach

The primary and secondary concentration steps in Figure 8 and its details are shown in Figures 8a,b. In this approach, the lower tonnage is introduced into the secondary concentration section, and also the pulp density of the input to the secondary concentration stage is much lower than the traditional circuit, which results in a higher recovery in the steps.

The purpose of the primary concentration stage in Figure 8 is only to achieve the highest recovery value, and the grade is not very significant at this stage. In order to maintain the results of both the traditional and the new approaches, the recovery in the primary and secondary concentration stages were considered to be 85% and 88%, respectively, and therefore, the total recovery would be 75%

(85\*88/100), while in the new approach, due to more control over the operating conditions, there is a possibility of achieving higher recoveries. For example, in the secondary concentration stage, the recovery can increase by reducing the tailing grade. The results of some research works have also shown that the recovery in coarse-sized particles can reach up to 95% or even more [23]. In addition, increasing the grade and decreasing the density of the pulp entering the secondary concentration section could increase the recovery in each stage. It is assumed that this increase in recovery of the rougher, scavenger, and cleaner stages leads to 70, 80, and 55%, respectively. In such a case, the mass balance calculations for the secondary concentration circuit are obtained as in Table 4.



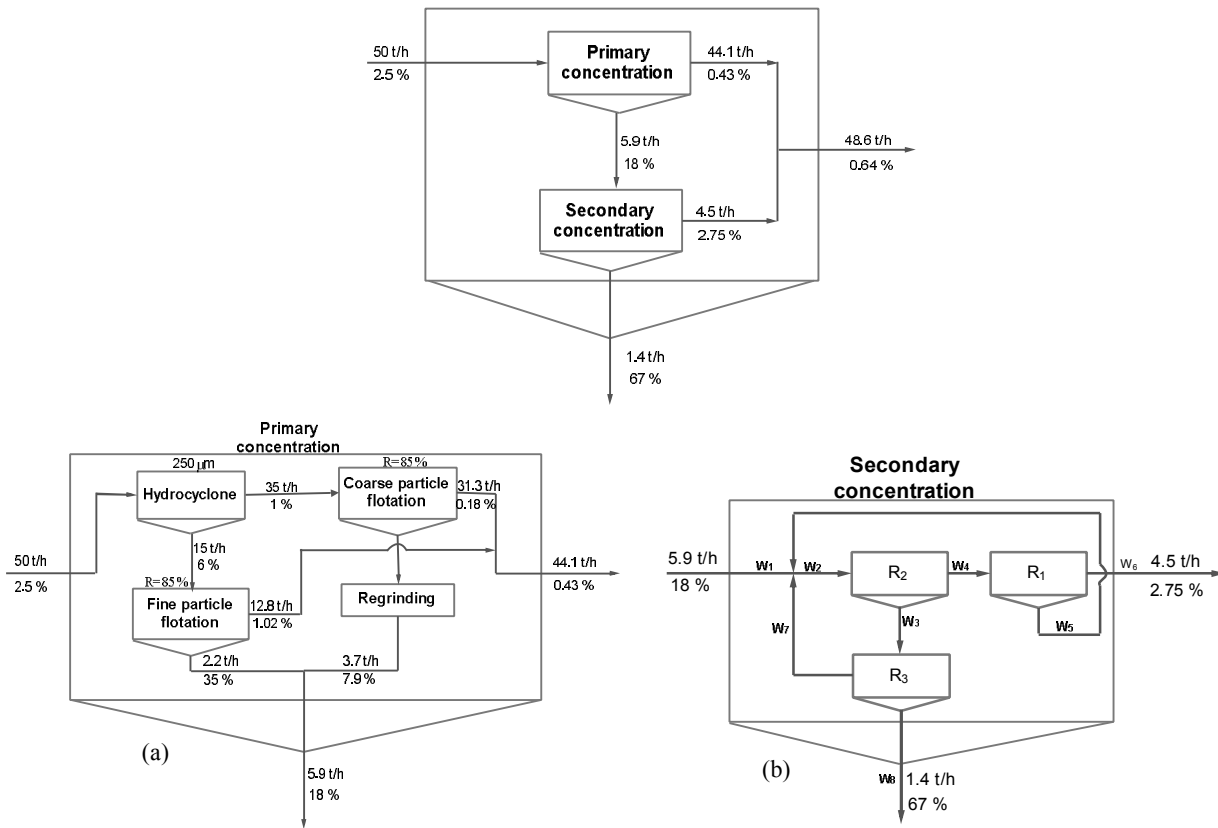

Figure 8. Primary and secondary concentration steps and details: a) primary and b) secondary units.

Table 4. The mass ratio and stream metal content in new approach.

Stream i	$w_i / w_1$	Metal content
$w_1$	1	1.06
$w_2$	2	2.12
$w_3$	1.6	1.70
$w_4$	0.4	0.42
$w_5$	0.28	0.30
$w_6$	0.12	0.13
$w_7$	0.72	0.76
$w_8$	0.77	0.93

**Verification:**  $w_1 = w_6 + w_8$

Tables 3 and 4 show that the amount of metal in the final concentrate is equal to 0.93 t/h, while the amount of metal entering the traditional and new circuits are 1.25 and 1.06 t/h, respectively. As a result, by reducing the amount of the gangue mineral fraction, more suitable conditions are provided to achieve the maximum grade and recovery. Some other benefits of the new approach are listed as follow:

- It is possible to enter the output of the rod mill to the pre-concentration stage and use a smaller mill

to reduce the size of the concentrate obtained from the coarse-sized particles.

- The input to the secondary concentration circuit in Figure 8 has the characteristics such as low tonnage, desired grade, and low pulp density. These all would facilitate the circuit control, and therefore, improve its efficiency.

- Previous experiments and some studies have shown that zinc minerals are often liberated in coarse size from their gangue [20, 21]. Usually in the lead and zinc flotation plants, lead is initially

separated and zinc is then processed. Under such condition, if the lead is liberated in a fine size fraction from its gangue, it is required to be fine enough to achieve the desired degree of liberation. This, in turn, leads to an excessive grinding of the zinc ore on the entrance the flotation section, and except for reducing the process efficiency, it can increase the consumption of chemicals as well. Therefore, the new approach emphasizes the production of the course-sized tailing in the lead flotation part.

#### 4. Conclusions

In this research work, a new approach was proposed based on more control over unit operations in the design of flotation circuits. The results of this work can be summarized as follow:

- 1) This paper has clearly shown that the highest amount of recovery in all types of flotation circuit layouts must be allocated to the first separation stage.
- 2) Presentation of a new approach for specialization of the flotation process based on the size of the input particles and the separation equipment. Firstly, the feed in two fractions with coarse and fine size is to be processed in order to reach the concentrate containing the most valuable particles. The resulting concentrate is then introduced to the secondary separation circuit to maximize the amount of grade and recovery.
- 3) Usage of conventional flotation circuits for processing the low density froth stream from the pre-concentration stage, which leads to an increase in the recovery and reduce in the energy consumption.

#### Acknowledgments

The authors would like to express their special thanks of gratitude to the Bama Mining Company for assistance supplied throughout the period of the test work.

#### References

[1]. Noble, A. and Luttrell, G.H. (2015). A review of state-of-the-art processing operations in coal preparation. *International Journal of Mining Science and Technology*. 25 (4): 511-521.

[2]. Boroski, M., Rodrigues, A.C., Garcia, J.C., Gerola, A.P., Nozaki, J. and Hioka, N. (2008). The effect of operational parameters on electrocoagulation- flotation process followed by photocatalysis applied to the decontamination of water effluents from cellulose and paper factories. *Journal of Hazardous Materials*. 160 (1): 135-141.

[3]. Labidi, J., Pelach, M.A., Turon, X. and Mutje, P. (2007). Predicting flotation efficiency using neural networks. *Chemical Engineering and Processing: Process Intensification*. 46 (4): 314-322.

[4]. Wills, B.A. and Finch, J. (2015). *Wills' mineral processing technology: an introduction to the practical aspects of ore treatment and mineral recovery*: Butterworth-Heinemann.

[5]. Mehrabani, J.V., Noaparast, M., Mousavi, S.M., Dehghan, R. and Ghorbani, A. (2010). Process optimization and modelling of sphalerite flotation from a low-grade Zn-Pb ore using response surface methodology. *Separation and Purification Technology*. 72 (3): 242-249.

[6]. Al-Thyabat, S. (2008). On the optimization of froth flotation by the use of an artificial neural network. *Journal of China University of Mining and Technology*. 18 (3): 418-426.

[7]. Guria, C., Varma, M., Gupta, S.K. and Mehrotra, S.P. (2009). Optimal synthesis of an industrial fluor spar beneficiation plant using a jumping gene adaptation of genetic algorithm. *Minerals and Metallurgical Processing*. 26 (4): 187 - 202.

[8]. Cisternas, L.A., Méndez, D.A., Gálvez, E.D. and Jorquera, R.E. (2006). A MILP model for design of flotation circuits with bank/column and regrind/no regrind selection. *International Journal of Mineral Processing*. 79 (4): 253-263.

[9]. Schena, G., Zanin, M. and Chiarandini, A. (1997). Procedures for the automatic design of flotation networks. *International Journal of Mineral Processing*. 52 (2-3): 137-160.

[10]. Mehrotra, S.P. and Kapur, P.C. (1974). Optimal-suboptimal synthesis and design of flotation circuits. *Separation Science*. 9 (3): 167-184.

[11]. Hu, W., Hadler, K., Neethling, S.J. and Cilliers, J.J. (2013). Determining flotation circuit layout using genetic algorithms with pulp and froth models. *Chemical Engineering Science*. 102: 32-41.

[12]. Ghobadi, P., Yahyaei, M. and Banisi, S. (2011). Optimization of the performance of flotation circuits using a genetic algorithm oriented by process-based rules. *International Journal of Mineral Processing*. 98 (3): 174-181.

[13]. Mendez, D.A., Gálvez, E.D. and Cisternas, L.A. (2009). State of the art in the conceptual design of flotation circuits. *International Journal of Mineral Processing*. 90 (1-4): 1-15.

[14]. Reuter, M.A. and Van Deventer, J.S.J. (1990). The use of linear programming in the optimal design of flotation circuits incorporating regrind mills. *International Journal of Mineral Processing*. 28 (1-2): 15-43.

- [15]. Noble, A. and Luttrell, G.H. (2014). The matrix reduction algorithm for solving separation circuits. *Minerals Engineering*. 64: 97-108.
- [16]. Lynch, A.J., Johnson, N.W., Manlapig, E.V. and Thorne, C.G. (1981). Mineral and coal flotation circuits-their simulation and control. (Developments in mineral processing. no. 3). Elsevier Scientific Publishing Co., xiv+ 291, 24 x 16 cm, illustrated (USDollars U. S. 63. 50).
- [17]. Denver Flowsheets. (1962). Modern Mineral Processing, Denver Equipment Company. Denver, Colorado.
- [18]. Sutherland, D.A. (1981). Study on the optimization of the arrangement of flotation circuits. *International Journal of Mineral Processing*. 7 (4): 319-346.
- [19]. Franco, J.J.C., Castillo, M.F., Concha, J., Christodoulou, L. and Wasmund, E.B. (2015). Coarse gold recovery using flotation in a fluidized bed. In Proceedings of the 13<sup>th</sup> Canadian Mineral Processors Conference, Ottawa, Canada.
- [20]. Fosu, S., Awatey, B., Skinner, W. and Zanin, M. (2015). Flotation of coarse composite particles in mechanical cell vs. the fluidised-bed separator (The HydroFloat™). *Minerals Engineering*. 77: 137-149.
- [21]. Awatey, B., Skinner, W. and Zanin, M. (2015). Incorporating fluidised-bed flotation into a conventional flotation flowsheet: A focus on energy implications of coarse particle recovery. *Powder Technology*. 275: 85-93.
- [22]. Newcombe, B., Wightman, E. and Bradshaw, D. (2013). The role of a flash flotation circuit in an industrial refractory gold concentrator. *Minerals Engineering*. 53: 57-73.
- [23]. Awatey, B., Thanasekaran, H., Kohmuench, J.N., Skinner, W. and Zanin, M. (2013). Optimization of operating parameters for coarse sphalerite flotation in the HydroFloat fluidised-bed separator. *Minerals Engineering*. 50: 99-105.

## تخصصی‌سازی مراحل برای طراحی و آنالیز مدارهای فلوتاسیون

وحید رادمهر، سید ضیاءالدین شفائی تنکابنی\*، محمد نوع‌پرست و هادی عبداللهی

دانشکده مهندسی معدن، دانشکده‌های فنی، دانشگاه تهران، ایران

ارسال ۲۰۱۸/۲/۱۴، پذیرش ۲۰۱۸/۷/۸

\* نویسنده مسئول مکاتبات: zshafaie@ut.ac.ir

---

### چکیده:

پژوهش حاضر یک روش جدید برای طراحی مدار فلوتاسیون ارائه کرده است. در ابتدا به صورت تحلیلی و عددی اثبات شده است که به منظور دستیابی به بالاترین بازیابی در چیدمان‌های متفاوت، بهترین تجهیزات باید در مرحله آغازین مدارهای فلوتاسیون قرار داده شود. ابعاد ذرات ورودی و انواع جریان‌های حاوی پالپ و کف به عنوان مبنایی برای تخصصی‌سازی فرآیندهای فلوتاسیون مد نظر قرار گرفت. در رویکرد جدید، فرآیند فلوتاسیون دارای دو نقش پرعیارسازی اولیه و ثانویه است. روش پیشنهادی برای یک مدار کارخانه فلوتاسیون سرب و روی به کار گرفته شد. نتایج به دست آمده نشان داد که در اغلب مدارهای مرسوم، بخش اعظم جریان‌های حاوی فلزات با ارزش به مرحله رافر برگشت داده می‌شود که به نوبه خود سبب کاهش کارایی و ایجاد اغتشاش می‌شود. در رویکرد جدید، فراهم کردن کنترل بیشتر بر روی واحدهای عملیاتی در مدار می‌تواند سبب کارایی بالاتر شود. علاوه بر این، در مواردی که کانی‌های روی در ابعاد درشت‌تر، از گانگ خود آزاد می‌شوند رویکرد جدید با ایجاد باطله دانه درشت می‌تواند از آسیاکنی بیش از اندازه کانی‌های روی در خوراک ورودی به مدار فلوتاسیون روی جلوگیری کند.

**کلمات کلیدی:** فلوتاسیون، طراحی مدار، تخصصی‌سازی، کارخانه فلوتاسیون سرب، پرعیارسازی اولیه و ثانویه.

---