

Performance of Profiled Vertical Reflective Parallel Noise Barriers with Quadratic Residue Diffusers

Monazzam, M.R.* and Nassiri, P.

Occupational Hygienic Department, Scholl of Public Health, Tehran University of Medical Sciences, Tehran, Iran

Received 10 March 2008;

Revised 15 June 2008;

Accepted 25 June 2008

ABSTRACT: The paper presents the results of an investigation on the acoustic performance of vertical profile parallel barriers with quadratic residue diffuser tops and faces. A 2D boundary element method (BEM) is used to predict the barrier insertion loss. The results of rigid and with absorptive coverage are also calculated for comparisons. Using QRD on the top surface and faces of all vertical profile parallel barrier models presented here is found to improve the efficiency of barriers compared with fully absorptive equivalent parallel barrier at the examined receiver positions. It is found that reducing the design frequency of QRD shifts the performance improvement towards lower frequency, and therefore the most efficient model for vertical profile parallel traffic noise barrier is a setup treated with QRDs tuned to around 400 Hz. The overall performance improvement by the above diffusive barrier is predicted to be 5.8 dB (A) compared to its rigid equivalent barrier. It is also found that if increase in absorption coefficient of QRD by well reduction destroys the effect of wells in resonance; it will also have negative effect on the performance of parallel QRD barrier and will reduce the overall A-weighted insertion loss of the reactive barriers.

Key words: Parallel noise barrier, Diffusion, Boundary element, Quadratic residue diffuser

INTRODUCTION

Control of traffic noise by screens has been the subject of numerous investigations (Kurze, 1974, Monavari & Mirsaed, 2008). However little work have been reported on the effect of various parallel traffic noise barrier configurations, where a single barrier is placed on the other side of a roadway. This is mostly due to low perception of the problem, generally wide distance between some existing parallel barriers, lack of post construction measurements, unavailability of readily accessible analysis and design devices. Nonetheless, concern is increasing as more is achieved about the issue and greater needs for parallel traffic noise barriers are being identified. In this case the multiple reflections problem ranked as the highest priority item in a Transportation Research Board survey based on Federal Highway Administration (FHWA) conference on traffic noise research needs (Bowlby, 1986).

*Corresponding author E-mail: mmonazzam@hotmail.com

A detailed examination of previous literature on parallel barrier multiple reflections has shown that most of the previous research pointed to a quantifiable degradation in insertion loss due to the second barrier (Bowlby, 1984). It is shown that multiple reflections cause a significant rise in noise level in the screened area in addition to that expected behind a single noise barrier sited on one side of the road. Numerous scale and theoretical models and field studies at highway locations have shown that the rise in noise depends on the configurations range from zero to over 5 dB(A). In 1990, Tobutt and Nelson studied the effectiveness of absorptive treatment applied to 3 m high parallel set 45 m apart using computer model results. The difference in insertion loss with and without an effective absorptive treatment was from 1.5 to 3 dB(A) at spaces behind the barrier between 20 and 70 m length and up to height of 4.5 m (Tobutt & Nelson, 1990). A few years later Slutsky and Bertoni (1998) developed a specific

model to predict the effects of absorptive treatments and angled barriers where parallel barriers are utilized. They also demonstrated the advantages of using absorptive materials on the traffic faces of the barriers. In this case they found that with 4.5 m high barriers set 45 m apart over hard ground the reduction in noise levels when using absorptive material was 4.5 dB at 45 m behind the barrier. Although in this research the height of receiver is not given, it compares favorably with the results of Tobutt and Nelson for similar geometry. They also found that where the barriers are only 18 m apart the average improvement in insertion loss resulting from using absorptive material rose to approximately 6 dB at the same distance. (Slutsky & Bertoni, 1998). This is worth noted that Hjak in 1980 with field trials of parallel barriers 3 m high sited 74 m apart showed no significant degradation in acoustic performance. This was described by the large separation and seems reasonable conclusion considering the reduction in performance between absorptive and rigid barriers with increasing separation distance introduced by Slutsky and Bertoni (1998). Moreover, a study by Nelson et al on one of UK's wide highway also failed to show a reduction in performance when 3 m rigid barriers were placed 33 m away on the far side of the carriageway (Nelson, et al., 1976). In 1986 Bowlby introduced a validated Image program to predict the degradation in insertion loss when parallel noise barriers are located on opposite sides of a highway. The study identified that any reduction in performance can be eliminated through the use of sound absorptive noise barriers (Bowlby & Cohn, 1986).

In 1993 a set of field measurements of noise, traffic, and meteorology were made by Hendricks in three stages: before barrier construction, after construction of the near barrier, and after construction of the barrier on the opposite side of a highway. The results showed reduction of 0 to 1.9 dB (A), independent of wind. Vector wind velocities of -3 to +11 mph caused variations in noise levels of up to 9 dB (A) at 70 m behind the near barrier (Hendricks, 1993). Watts also examined the performance of parallel traffic noise barrier by a full scale method. It was concluded that the screening performance of a single 2 m high reflective barrier on the nearside is reduced

by 4 dB (A) when a rigid barrier of similar height is placed at the edge of the far side carriageway. It was shown that both sound absorbing barriers and tilted barriers are effective in degradation of single barrier performance due to unwanted reflected paths (Watts, 1996).

Studies have also suggested that to reduce the degradation in the performance of parallel reflective noise barriers, the width-to-height ratio of the roadway section to the barriers should be at least 10:1. The width is the distance between two barriers, and the height is the average height of the barriers above the roadway. This means that two parallel barriers 3 meters high should be at least 30 meters apart to avoid any reduction in effectiveness. This model is suffering from its feasibility in the real application due to land taking or aesthetic aspects of it. A popular way of reduction in multiple reflections is utilizing sound absorptive materials. Recently numerous researches have been conducted to improve the performance of parallel traffic noise barrier by incorporating sound absorptive elements. In this case Watts and Godfrey by a field measurement study showed a fairly significant improvement by changing the barrier face from reflective to sound absorptive (Watts & Godfrey, 1999).

One more condition with multiple reflections is the tall building effect on barrier performance effect. In this case a ray model by Li and Tang was developed and validated for the prediction of the insertion loss of barriers that are located in front of a tall building in high-rise cities. In the model the diffraction and multiple reflection effects were included since they play important roles in determining the overall sound pressure levels for receivers located between the façade and barrier. They showed reasonably good agreement over a broad frequency range compared with field measurement and boundary element method. They also raised the significance of positioning the barrier relative to the noise-sensitive receivers in order to achieve improved shielding efficiency of the barrier (Li and Tang, 2003). Li et al also in 2008 developed and validated a ray model for prediction of the insertion loss of hard parallel noise barriers placed either in front of a row of tall buildings or in a street canyon. Comparisons of the ray model with a wave-based boundary element formulation show reasonably good

agreement over a broad frequency range (Li *et al.*, 2008).

In order to suppress the edge effect of reflective noise barriers the reactive barriers are also introduced by Fujiwara (Fujiwara, 1990) at which the efficiency of the “soft” barrier increased by more than 10 dB in the frequency range with lowest surface pressure. In 2007 also the acoustic performance of pairs of diffusive roadside barriers was tested experimentally in a scale model, and compared to that of reflecting barriers. Significant attenuation benefits were detected not only in the shadow zone behind the barriers, but also above the barriers, thus proving that diffusive traffic faces of the barriers may effectively help in canceling out multiple reflection effects (Cianfrini *et al.*, 2007). Application of quadratic residue diffuser (QRD), on different reflective single barrier profiles is also investigated by Monazzam & Lam, 2005, where the best shape for using the device was found to be a T-shape profile. Although the utilized surface is well known as a diffuser that spreads sound in many directions with very low loss in energy, there are also a few studies showing that they can also work as an absorbent device (Commins *et al.*, 1988 ; Fujiwara, 1992 ; Kuttruff, 1993 ; Fujiwara, 1995). This paper investigates the effect of a new set of vertical parallel traffic noise profile barrier using the most common Schroeder diffuser, which is quadratic residue diffuser, on both top surface and also barrier roadside faces. In this paper the single reference reflective barrier is a vertical rigid T-shape barrier which has been shown by numerous papers that it is a barrier with high performance and also the best shape for using both absorptive and diffusive elements (e.g. Hothersall *et al.*, 1991; Monazzam & Lam, 2005). In this report the performance of upright parallel noise barrier with quadratic residue diffuser either on the top surface or on the barrier roadside faces with different frequency design and properties, is predicted using a two dimensional boundary element method. Insertion loss at 1/3 - octave centre frequencies are calculated. The results are also compared with reflective as well as equivalent absorptive vertical parallel barrier on the rigid ground to show that it is efficient to use ribbed surfaces instead of absorptive elements on parallel barrier to contradict the effects of multiple reflections in these kinds of problems.

MATERIALS & METHODS

Quadratic Residue Diffuser (QRD) is a phase grating diffuser that consists of a series of wells of the same width and different depths. The wells are separated by thin fins. Within one period, the depths of the wells are determined by a quadratic residue sequence. In each well, the incident wave will excite a pressure wave traveling toward the rigid bottom from which it is reflected. After returning to the entrance plane of the structure, these waves will have undergone different phase shifts corresponding to the different path lengths they have traveled. If the phase differences are sufficiently large, the structure will produce a significant scattering of the reflected wave, with scattering characteristics depending on the depth sequence of the elements. Ideally a QRD should produce a uniform scattered field within its design frequency range.

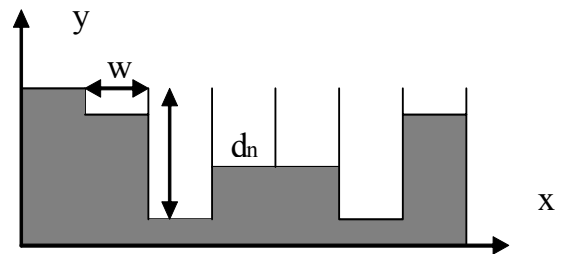

Fig. 1. A one dimensional cross-section of an N=7 quadratic residue diffuser

The sequence number for the n-th well, s_n , is given by:

$$s_n = n^2 \text{ mod } N, \tag{1}$$

Where modulo (mod for short) is the least non-negative remainder. N is the prime number, which is also the number of wells per period. For example one period of an N=11 QRD has $s_n = \{0,1,4,9,5,3,3,5,9,4,1\}$. The diffuser has best performance at integer multiples of a design frequency, f_0 . The design frequency is usually set as the lower frequency limit. It is always found more convenient to use wavelength λ_0 in the formulations instead of frequency. The depth of n-th well d_n (see Fig.1) is calculated from the sequence using the following equation:

$$d_n = \frac{s_n \lambda_n}{2N} \tag{2}$$

Therefore, the well depths vary between zero and approximately half the design wavelength. The design frequency is not the lowest frequency at which the diffuser makes more scattering than a plane surface; it is the first frequency at which the scattering can have uniform energy diffraction lobes. It is worth adding that the diffuser design theory is correct while plane wave propagation within wells exist. Therefore, an upper frequency limit can approximately be found from:

$$\lambda_{\min} = 2w \quad (3)$$

Where w is well width. (see Fig.1). Many more information with more details on the design, diffusive and absorptive properties of this kind of surfaces can be found in the Cox and D'Antonio's book (Cox & D'Antonio, 2004) and Monazzam's recent paper (Monazzam & Lam, 2008). A vertical parallel noise barrier of infinite length lies on the plane, and it is assumed that the acoustical properties and the cross-section shape of the noise barriers do not vary across their length. Therefore the problem is reduced to two-dimensional, with the z-axis parallel to the parallel barrier length, and all the geometrical and acoustical variables remains constant in the z-direction. The barrier surfaces are assumed to be locally reacting with specific surface admittances. The Helmholtz wave equation is then solved by the boundary integral equation at a single frequency using boundary element method. Full detail of the method can be found in (Monazzam & Lam, 2005). In the numerical simulations, dimension of elements was taken to be less than $\lambda/5$ to give a reasonable representation of constant surface pressure over an element. In the cases with welled structure, the ribbed surfaces are represented by a box with the top surface having an admittance distribution as given by the simple phase changes due to plane wave propagation inside the wells. Using this method it is much easier to do the calculations over a wide range of barrier designs, and the validation result of this assumption on QRD barriers is presented by Monazzam and Lam, 2008. The interference between the source and its ground image was minimized by locating the sound source very close to a rigid ground. The ground is always taken to be rigid. In this investigation a T shape profile barrier (barrier number 1 of the vertical parallel barrier) is always used for co-

ordination. Distance from the source to the centre line of the barrier is kept at 5 m. The sound pressure is predicted at 1/3-octave centre frequencies between 50 and 4000 Hz at different receiver locations. The insertion loss at each frequency is calculated by:

$$IL = -20 \log_{10} |p_b/p_g| \text{ dB}, \quad (4)$$

where p_b is the pressure with both the ground and barrier present and p_g is the pressure at the receiver with only the rigid ground present. For the simulation of the effect of absorbent surfaces, a fibrous material is assumed and the empirical formulae of Delany and Bazley, 1970, are used for the calculation of the characteristic impedance and propagation constant of the fibrous material. The normalized specific impedance of the wells of quadratic residue diffuser is calculated by the method introduced by Wu *et al.*, 2001. In this method the viscous and thermal losses in the wells are also taken in account, although if the surfaces of the wells are rigid and it is sufficiently wide the viscous and thermal losses are generally small and can be ignored.

RESULTS & DISCUSSION

The performance of a few different shapes of vertical parallel noise barriers with different configurations has been predicted using 2D-boundary element method. The typical design used in the simulation is shown in (Fig. 2.) Barrier No.1 is a T shaped barrier and barrier No.2 is a vertical plain barrier which is sited in 40 m distance with barrier No.1. As it is shown in the (Fig. 2). the overall heights of both barriers are the same and it is fixed at 3m, which is typically used in literature. In all models the stem and cap thickness of barrier No.1 is respectively 0.1 and 0.3 m. The width of the T top in T-shape barrier is 1m. This width is mostly used because in most areas highway traffic noise has a dominant frequency of approximately 550 hertz, resulting in a wavelength approximately 2 feet long (FHWA 1980), a 3-feet (1 m) width for T-top is used to ensure adequate performance of the top edge of barrier No1. These dimensions are similar to those used in previous studies (Hothersall, *et al.*, 1991; Crombie, *et al.*, 1995; Fujiwara *et al.*, 1998; Monazzam & Lam, 2008). In all models the stem

of barrier No.2 is 0.3 m. This thickness for the stem in barrier No.2 and the cap in barrier No.1 is used to ensure enough space for utilizing different QRD designs on these surfaces.

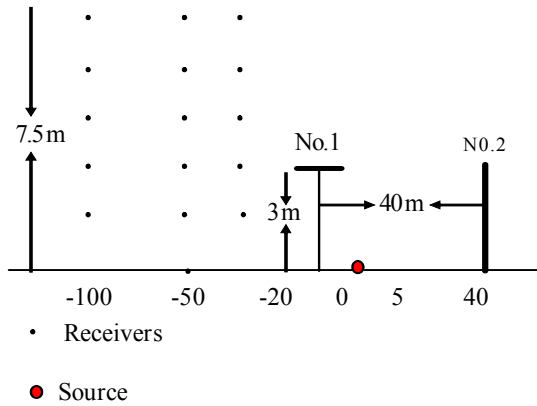

Fig. 2. Schematic set up of the vertical parallel barrier (Source and receivers locations are also included, dimensions are in m)

As it is shown in Fig. 2. the 16 receiver points model a wide field behind barrier number 1 from 20 to 100 m on ground extended to height of 7.5 m. The receiver's coordinates and numbers are introduced in (Table 1). The source is located at coordinate (5, 0.02). Three different surfaces were used on the barrier including:

- 1) Rigid surface: All surface admittances are zero, which is the Neumann boundary condition.
- 2) Absorbing surface: The upper surface of the cap in barrier No.1 and roadside of barrier No.2 is covered with fibrous absorptive material. The flow resistivity of the fibrous material is taken to be $20000 \frac{N.s}{m^4}$. The thickness of the fibrous material is fixed at 0.2445 m (the same as the thickness of the QRD).
- 3) QRD barrier: Quadratic residue diffusers with different designs are fixed to the surface of barrier No.1 and roadside of barrier No. 2 shown in Figure 2 with the overall height remained constant.

Different designs are used to examine how diffusers affect the performance of vertical parallel barriers. The different designs and their model names are given in (Table 2). The dimension of one of the tested QRD designs in the top surface of barrier No.1 and the vertical barrier No. 2 having 3 QRDs (labeled model "PGG" here) is shown in detail in (Fig. 3).

Table 1. Coordinates and the numbers of receiver points

Receiver No.	Distance from Barrier No.1(m)	Height above rigid ground(m)
1	50	0
2	20	1.5
3	50	1.5
4	100	1.5
5	20	3
6	50	3
7	100	3
8	20	4.5
9	50	4.5
10	100	4.5
11	20	6
12	50	6
13	100	6
14	20	7.5
15	50	7.5
16	100	7.5

In order to investigate to what extent the QRD barriers reduce the degradation effect of multiple reflection effect of specular reflective parallel barrier, the results are compared against an equivalent vertical rigid parallel barrier.

The effect of multiple reflection on vertical plain parallel barriers by many investigators (e.g. Watts, 1996), but this effect on profile vertical barrier also needs to be tested. This is why in this investigation the effect of a plain vertical barrier when is erected in front of a T shaped barrier with 40 m distance is studied. A comparison on the performance of two different conditions including a T shaped barrier with no multiple reflection degradation effect (barrier model T) and its equivalent condition with the multiple reflection reduction effect (barrier model PT) in 1/3 octave center frequencies is made in (Fig. 4). In barrier model T all the surface conditions and source positions are exactly the same as barrier model PT, the only difference is the multiple reflection effect resulting from barrier No.2.

As one can clearly see from (Fig.4). the performance of barrier model PT is reduced dramatically almost in all frequency bandwidth apart from 125 Hz, which can be explained by the constructive effect of incident and reflected waves in this special geometry. The performance of the parallel barrier is highly frequency selective

Table 2. Design model names and corresponding configurations

Model	Barrier No.1	Barrier No.2
PT	RIGID	RIGID
PAT	T part is covered with fibrous material	Rigid
PAAT	T part is covered with fibrous material	Roadside is covered with fibrous material
PG	QRD edged $f_r=400$ Hz $w=12$ cm	RIGID
PGA	QRD edged $f_r=400$ Hz $w=12$ cm	3 QRD at the roadside $f_r=1$ kHz, $w=12$ cm
PGG	QRD edged $f_r=400$ Hz $w=12$ cm	3 QRD at the roadside $f_r=400$ Hz, $w=12$ cm
PAA	QRD edged $f_r=1$ kHz $w=12$ cm	3 QRD at the roadside $f_r=1$ kHz, $w=12$ cm
PHH	QRD edged $f_r=400$ Hz $w=6$ cm	6 QRD at the roadside $f_r=400$ Hz, $w=6$ cm
PII	QRD edged $f_r=400$ Hz $w=2$ cm	12 QRD at the roadside $f_r=400$ Hz, $w=2$ cm

Note. The overall surface and thickness of fibrous material in absorptive barrier models is the same with those of in their equivalent diffusive barrier models

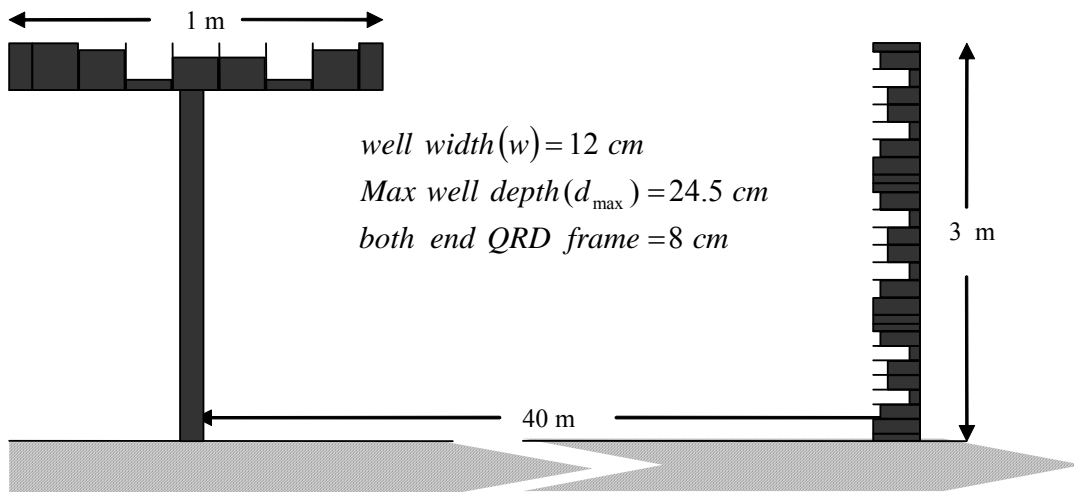

Fig. 3 . Dimensions of the T-shape barrier (barrier No.1) having a QRD ($N = 7^*$ and $f_r = 400$ Hz) and the vertical barrier No.2 having 3 QRDs ($N = 7$ and $f_r = 400$ Hz) in parallel barrier model “PGG”

* The number of wells is 7 ($N=7$) but one well (the first one from left hand side) has a zero depth therefore in the figure one can just see 6 distinct wells

due to constructive and destructive effects of incident and reflected rays according to the geometry of the boundary and wavelength of the wave. The performance of the barrier model T due to lack of multiple reflection degradation is much higher and less frequency selective. As it was expected the performance of the designed single barrier improves as frequency increases. This is of course predictable that with changing the geometry say receiver position the performance of both barriers will change but parallel barrier is more dependant to the geometry, this is why in this investigation 16 receivers points are examined. The results for the 16 receivers showed that the performance of parallel barrier compared to that of in equivalent single T shaped barrier is getting worse in most frequencies in far field especially

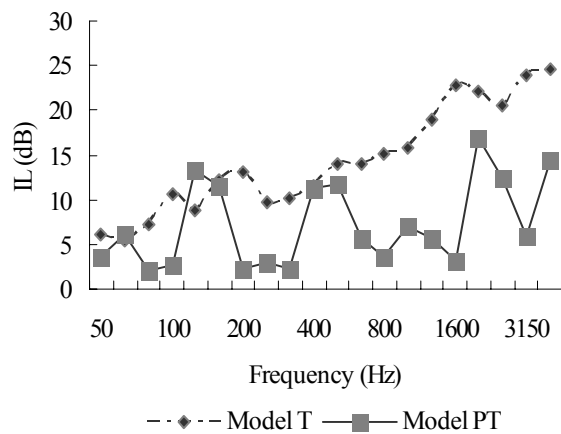

Fig. 4. Predicted spectra of Insertion Loss for single vertical T shaped rigid barrier along with its equivalent parallel barrier at receiver point (-50, 0)

above barrier's height. In order to average the interference effects observed at single frequencies, and allow smoother trends to be identified more easily, the A-weighted road traffic noise spectrum (BS EN 1793-3:1998) is calculated by combining the results for insertion loss at one-third octave band centre frequencies over the range 50–4000 Hz and assuming a suitable source spectrum.

The A-weighted mean reduction of insertion loss by multiple reflections which is created by barrier model PT at 16 receivers is presented in (Table 3). The average 12 dB (A) decrease in overall performance behind the vertical profile parallel barrier is a significant reduction which is presented in the table. It means the overall performance gets less than half that of a single equivalent T shaped barrier due to multiple reflections. Apart from the receiver number 14 which has certain geometry in this designed model with destructive wave interference effect, with increase in the distance and height the effect of multiple reflection degradation increases. Referring to previous studies, a single T shaped barrier has around 3 dB (A) higher performance than its equivalent plain barrier and in here we see the amount of overall degradation is also 3 dB(A) is higher than that of in the results of previous paper for vertical plain parallel barrier (Hothersall, *et al.*, 1991; Watts, 1996). It means the reflections from second barrier almost remove the benefits of the cap of the barrier number 1. In other word any attempt for improving the performance of a single rigid profile barrier can be removed, if nothing done for absorbing or diffusing the reflections from different surfaces of both barriers. The most contributing surfaces in the problem raised in this investigation are the top surface of barrier number 1 and roadside surface of barrier number 2.

In this part of the study assuming the dominant frequency of around 500 Hz for highway traffic noise a set of calculations in a wide area (400 receiver points) for the reduction of performance of parallel barrier in both far and near field is also done and the result is shown in a contour graph. The studied area was from 2 to 50 meter distance from barrier number 1 from ground to the height of 7 meter. It should be noted in our designed model geometry the 500 Hz has a very low overall

Table 3. The A-weighted mean reduction of insertion loss of barrier model PT compared to that of in barrier model T

Receiver No.	The A-weighted mean reduction of insertion loss(dB(A))
1	9.2
2	8.3
3	9
4	9.1
5	10.1
6	11.1
7	11.2
8	14.3
9	13.5
10	12.6
11	13.6
12	15.6
13	14.1
14	7.5
15	16.5
16	15.7
Average (App.)	12

degradation, which can get higher in different geometry. The reduction of performance in parallel barrier model PT compared to the single equivalent T shaped barrier is shown in (Fig. 5).

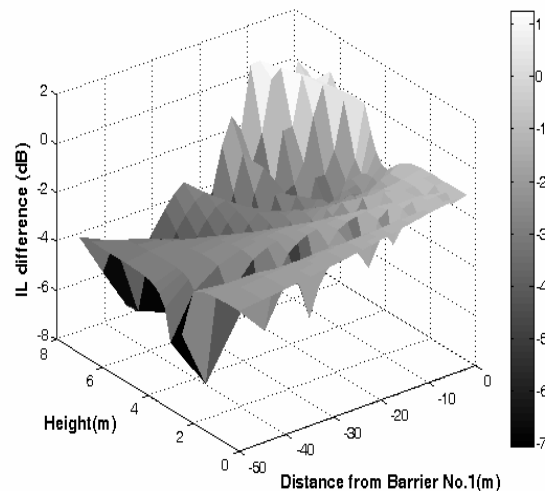

Fig. 5. The amount of reduction in insertion loss of barrier model PT compared to that of in barrier model T at 500 Hz in the wide field behind barrier number 1

As it is clearly seen from the contour the amount of reduction increases when height and distance increases, some thing that is also true for the overall performance of the profile parallel barrier as well. Of course one can found a very

narrow field in the illuminated zone that the destructive effect of the reflective waves from the top surface of barrier number 1 and waves coming from the roadside of the barrier number 2 is made slight improvement in the performance of the profile vertical parallel barrier.

The absorbent elements are used in this investigation to study the reflective wave absorption effect on the profile parallel noise barrier. In this case two different methods are introduced. Firstly the reflected wave from the top surface of T-shaped barrier is removed by covering just the top surface by fibrous materials (barrier model PAT) and secondly the reflective waves of both the top surface of barrier number 1 and also the roadside of barrier number 2 is vanished by utilizing absorbent elements (barrier model PAAT). To investigate the effect of top surface reflection of barrier number 1, a comparison between barriers models PT and PAT is made in (Fig. 6). Removing the top surface reflections by fibrous materials could slightly improve the performance of the barrier model PAT above 1 kHz compared to that of the rigid barrier model PT. Below 1 kHz no considerable improvement is made by fibrous material of the top surface of barrier number 1. The frequency selectivity behavior of rigid parallel barriers is also there with no considerable changes at entire frequency range. Though in both conditions above 1 kHz utilizing absorbent material is in favor of lessen the insertion loss degradation of parallel barrier. In 2 kHz the performance in barrier model PAT is even higher than the single T-shaped barrier, which shows the length of top surface covered with absorbent elements and also the geometry of the source/receiver and barriers dimensions plays an important role in improving the performance of partially absorbent parallel barrier as well. It can be predicted that by increasing the top surface dimension, the benefit of absorbent materials is shifted toward lower frequencies and the overall performance gets to some extent higher than the designed cap length. This is beyond the purpose of this investigation and will not be presented here.

The A-weighted mean insertion loss of partially absorbent parallel barrier is compared by its equivalent parallel as well as single T shaped barrier in (Fig. 7). Almost in entire receiver points slight overall improvement is visible, which is

achieved by the improvement in frequencies above 1 kHz as it was shown in (Fig. 6).

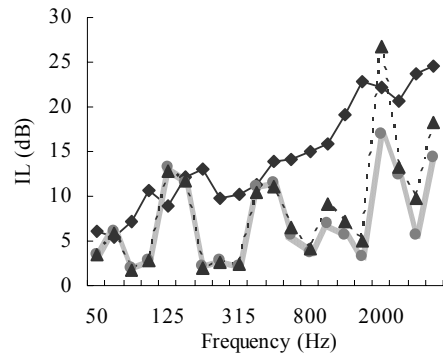

Model T Model PT Model PAT
Fig. 6. Predicted frequency spectra of barrier insertion loss for two different parallel barriers along with their equivalent T shaped single barrier at the receiver point (-50,0)

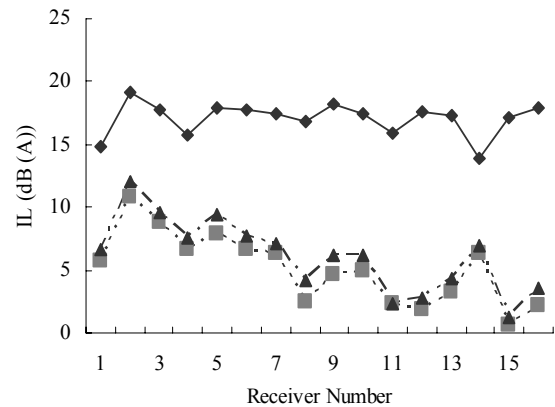

Model T Model PT Model PAT
Fig. 7. The A-weighted mean insertion loss for two different parallel barriers along with their equivalent T shaped single barrier at 16 receiver points

Covering the roadside of barrier number 2 as well as the top surface of barrier number 1 by fibrous material in parallel barrier model PAAT fairly improves the performance of its equivalent rigid parallel barrier model PT. The effective frequency is shifted toward frequencies lower than 1 kHz as one can see in (Fig. 8). This is made a fairly significant overall A-weighted improvement which is shown in (Fig. 9).

One more important result which is visible in Fig. 8. is that by removing a considerable reflection by absorbent element, the destructive effect of multiple reflections is slightly affected so that the performance of absorbent parallel barrier is not improved at those frequencies; even in some frequencies the slight reduction is also achieved.

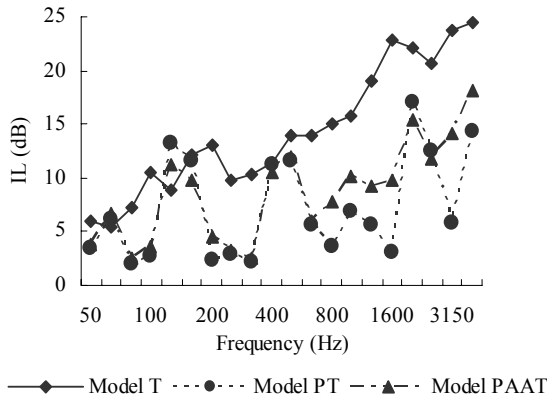

Fig. 8. Predicted frequency spectra of barrier insertion loss for two different parallel barriers along with their equivalent T shaped single barrier at the receiver point (-50,0)

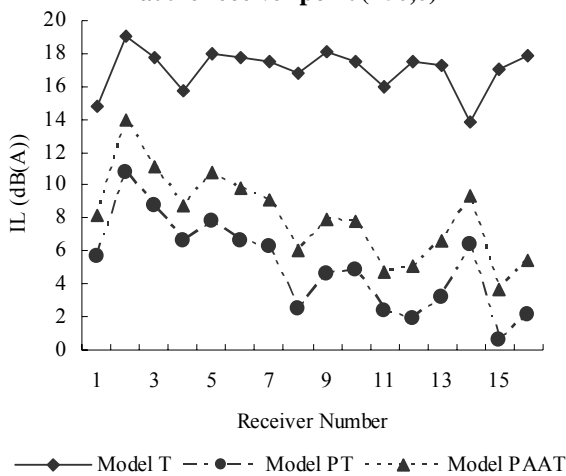

Fig. 9. The A-weighted mean insertion loss for two different parallel barriers along with their equivalent T shaped single barrier at 16 receiver points

In this case the performance of partially absorbent parallel barrier in 2 kHz (barrier model PAT) is more than that of absorbent parallel barrier (barrier model PAAT). An interesting result in absorbent parallel barrier model PAAT is its almost regular improvement in performance in 500 Hz in a wide field behind barrier number 1 according to (Fig.10). Nonetheless in this condition by removing the multiple reflection deconstructive effect in illuminated zone, a significant reduction of performance in absorbent compared to rigid parallel barrier in this area is shown in the contour graph.

In order to give a clear comparison of the results for different parallel QRD barriers, two different methods of incorporating absorbent materials are also used by QRD surfaces. In this case in the first model the top surface of barrier number 1 is covered

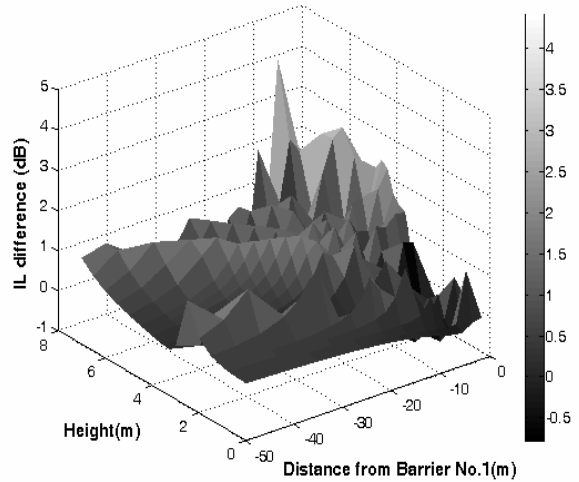

Fig. 10. The amount of improvement in insertion loss of barrier model PAAT compared to that of in barrier model PT at 500 Hz in the wide field behind barrier number 1

by QRD (barrier model PG) and in the second model both top surface and roadside of barrier number 2 are covered by QRDs (barrier model PGA). (Fig.11) shows the performance of partially diffusive parallel barrier model PG compared with the fully absorbent parallel barrier model PAAT in receiver point number 1.

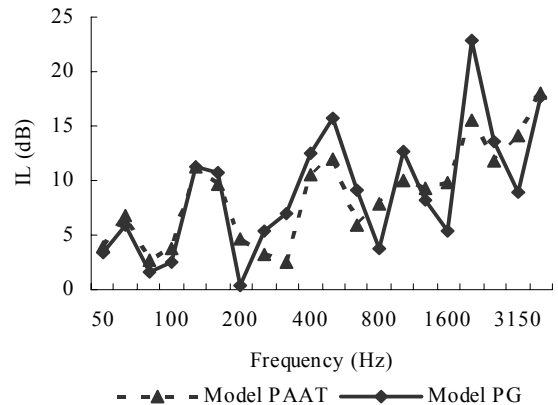

Fig. 11. Predicted frequency spectra of barrier insertion loss for barrier models PG and PAAT at the receiver point (-50,0)

Employing the designed QRD on model “PG” increases significantly the insertion loss of the barrier compared with the fully absorbent profiles parallel barrier at a wide frequency range above 315 Hz. Figure 11, clearly shows the peaks of insertion loss gained by model “PG” at 630, 1000 and 2000 Hz. Increases at 315, 500 Hz, 1.25 kHz are also significant. At frequencies lower than 315 Hz and above 2 kHz (outside the QRD frequency

bandwidth) the performance start to decline and go even slightly lower than absorptive shape at very low frequencies. In 800 and 1600 Hz which are the even function of frequency design of the utilized diffuser, the performance of the partially diffusive parallel barrier is reduced. The reason behind this phenomenon is explained in detail by Monazzam (Monazzam, 2005). Overall performance of the partially diffusive parallel barrier in dB (A) is also compared with its equivalent fully absorbent barrier in (Fig.12). The reason behind this significant improvement lies on the low frequency performance improvement, which is achieved by the designed diffuser. The very interesting result which is clearly visible in Figure 12 is that the overall improvement increases as the distance and heights of receivers increases. Some thing is favorable for the real application. In fact diffusing the wave arriving to the top surface of the barrier nearer to the receiver is reduced the main weakness or main degradation effect of the multiple reflection in the vertical parallel barrier. It is worth remembering that all vertical parallel barriers suffer form low performance in far field and high height. It is also predictable that with lowering the design frequency in this barrier configuration, higher overall performance is achievable due to shifting the effective frequencies to the lower frequencies by using QRDs with lower design frequency. The amount improvement in performance of parallel barrier model PG compared to its equivalent fully absorbent barrier model PAAT is shown in (Fig. 13). The amount of improvement is significant almost

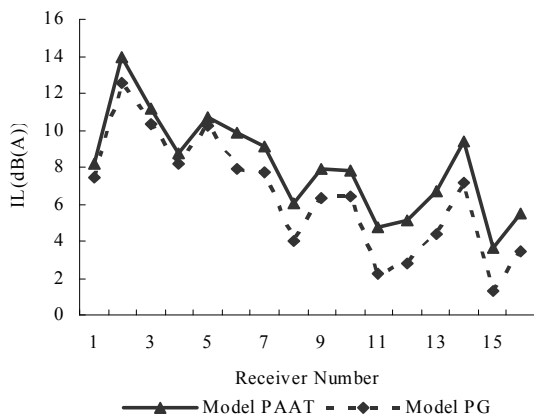

Fig. 12. The A-weighted mean insertion loss for partially diffusive parallel barrier model PG along with its equivalent fully absorbent barrier model PAAT at 16 receiver points

in entire field including far field and higher heights. The average improvement in the tested wide zone behind barrier number one is above 4 dB in 500 Hz. A weakness in this shape of barrier is its low performance at the heights close to the barrier height. This can be explained by the random and upward wave distribution rather than specular reflection of sound wave on this surface.

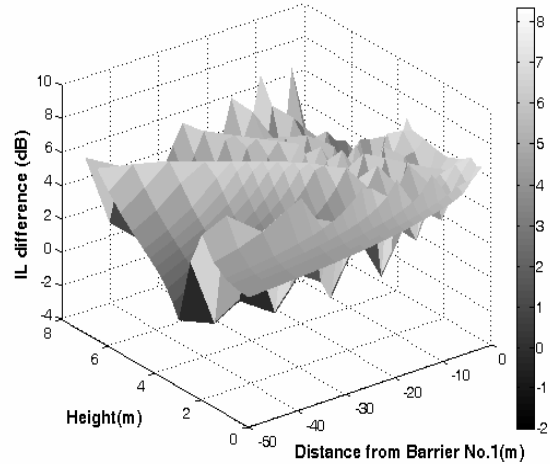

Fig. 13. The amount of improvement in insertion loss of barrier model PG compared to that of in barrier model PAAT at 500 Hz in the wide field behind barrier number 1

The acoustic performance of the second diffusive parallel barrier having diffusive surfaces on both top surfaces of barrier number 1 and the roadside of barrier number 2 in receiver number 1 is also compared with its equivalent partially diffusive and fully absorbent parallel barriers in (Fig. 14). The frequency design of QRDs used in the roadside of barrier number 2 is 1 kHz while the frequency design used on the top surface of barrier number 1 is 400 Hz. This is done to have a mixture of frequency designs in the diffusive parallel barrier and the selection of these wasn't by design. Although the optimization of this frequency designs mixture could be an interesting future work for further improvements of the QRD parallel barriers.

According to Fig. 14. the new designed barrier has better performance compared to both partially diffusive and fully absorbent parallel barriers in frequencies above 500 Hz, which is the product of two design frequencies. However using QRD with high design frequency couldn't improve the performance of barrier in low frequency even in some frequencies the performance is even lower

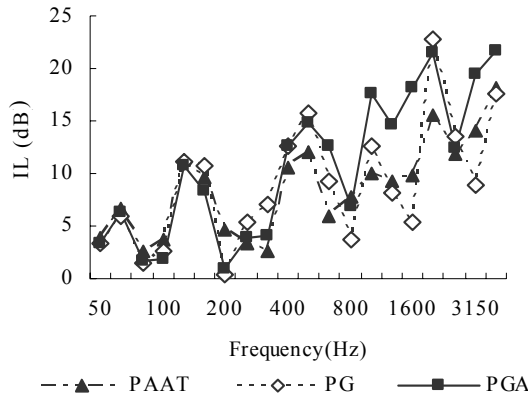

Fig. 14. Predicted frequency spectra of barrier insertion loss for barrier models PGA, PG and PAAT at the receiver point (-50, 0)

than the partially diffuse parallel barrier, which is because if the dominant effect of the QRD with higher design frequency and higher surfaces (3 QRDs with design frequency of 1 kHz are used on the roadside faces of barrier number 2 while just one QRD with design frequency of 400 Hz is implied on the top surface of barrier number 1). The A-weighted performance of three parallel barriers with different diffusive and absorption properties in 16 receiver points is compared in (Fig.15). Apart from receiver number 14 which has a special geometry in this investigation with high destructive wave interferences, the overall acoustical performance of the barrier model PGA is significantly higher than others. Increase in distance and height increases the efficiency of diffusive parallel barrier, as it was seen in the partially diffusive parallel barrier as well.

The performance of the diffusive parallel barrier in wide field behind barrier number 1 in 500 Hz is also compared with its equivalent fully absorptive parallel barrier model PAAT in (Fig. 16). The amount of improvement in this frequency is astonishing. This is of course because of the mixture of the utilized QRDs, which makes the barrier very effective in this frequency. The average 8.5 dB improvement compared to barrier model PAAT means doubling the performance of this barrier in 500 Hz. In this part of investigation the effect of *design frequency on profilecl* (QRDs) barriers with different frequency design is investigated. The performance of three different parallel QRD barriers at receiver number one is compared in 1/3 octave frequencies with that of rigid profile parallel barrier in (Fig.17).The

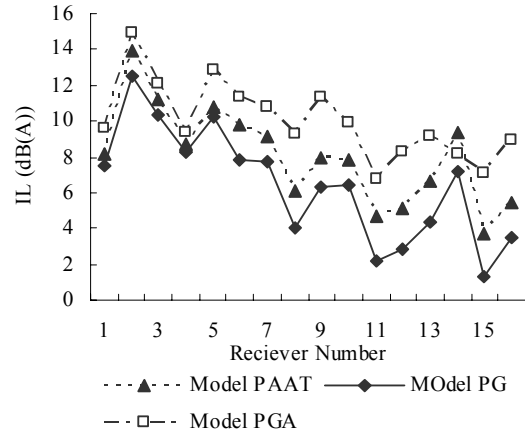

Fig. 15. The A-weighted mean insertion loss for diffusive parallel barrier model PGA along with its equivalent partially diffusive barrier model PG and fully absorbent barrier model PAAT at 16 receiver points

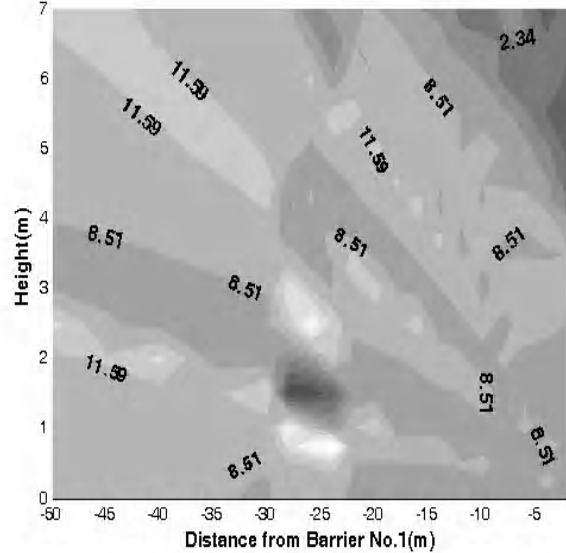

Fig. 16. The amount of improvement in insertion loss of barrier model PGA compared to that of in barrier model PAAT at 500 Hz in the wide field behind barrier number 1

improvements are stated at 400 and 630 Hz in QRD barrier models PGG and PAA with design frequencies of 400 and 1000 Hz respectively. While the barrier with a mixture of two different QRD with design frequency of 400 and 1000 Hz started to improve the performance of barrier from 500 Hz. This makes it easy to describe the effect of frequency design of QRD on the performance of parallel QRD barriers. The lower the design frequency provides the lower effective frequency, which means the higher overall performance will be achieved.

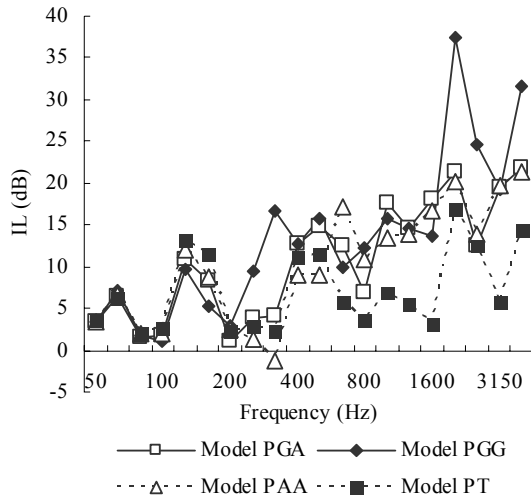

Fig. 17. Predicted frequency spectra of barrier insertion loss for barrier models PGA, PGG and PAA along with their equivalent rigid parallel barrier model PT at the receiver point (-50,0)

It is worth noted that in high frequency when the plane wave effects inside the wells are removed the results achieved in this investigation will not be longer correct since the prediction method is only correct when the plane wave exist within wells. In order To make a clear demonstration of frequency design effect a graph with frequency bandwidth equal to effective bandwidth of the utilized QRDs is made. The result is shown in (Fig. 18). As it is clearly seen from Figure 18 the first effective frequency is lower for the barrier with lower frequency design, which is barrier model PGG with design frequency of 400 Hz and it is the highest for the barrier with the highest design frequency, which is the barrier model PAA with design frequency of 1000 Hz. This phenomenon in single profile barrier with no multiple reflection effect has already been described by Monazzam (Monazzam, 2005), some thing is seen in parallel diffuser barrier as well. This describes the importance of design frequency and its influence on diffusive barriers either single or parallel. Though in parallel barriers the interference of extra surfaces (surface with no diffusers) makes the situation to some extent different compared to single profiled barrier, therefore in design models for the real application these extra interferences are also needed to be considered. However by comparing the overall performances of the above different diffusive parallel barriers in (Fig.19).no significant

difference is identified in far field and high heights, although at receivers with smaller distances or lower heights the overall performances are higher in the diffusive barriers with lower design frequencies.

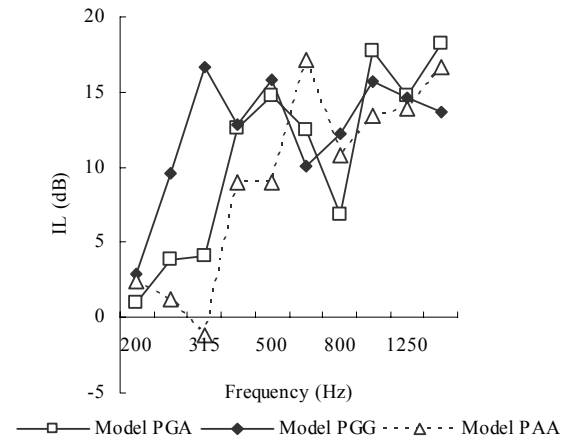

Fig. 18. Predicted frequency spectra of barrier insertion loss for barrier models PGA, PGG and PAA along with their equivalent rigid parallel barrier model PT within the frequency bandwidth of the utilized diffusers at the receiver point (-50,0)

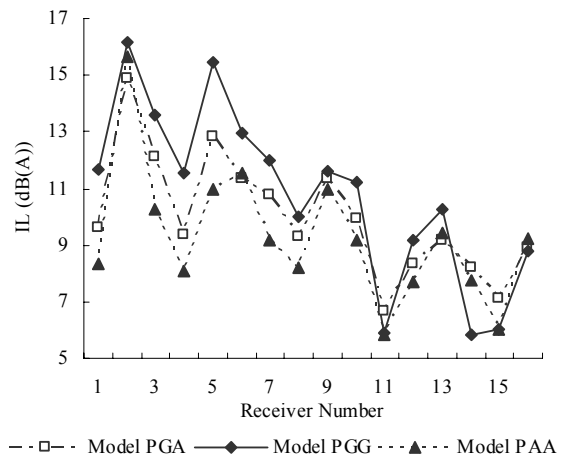

Fig. 19. The A-weighted mean insertion loss for diffusive parallel barrier models PGA, PGG and PAA at 16 receiver points

Among designed parallel QRD barriers, the best overall performance is achieved by introducing QRD with 400 Hz design frequency in barrier model PGG. The amount of increase in overall performance made by barrier model PGG in different receiver points is presented in (Table 4). The average improvement is 5.7 dB (A) and the worst performance is on the receiver point number 14. As a general rule one can identify the increase in performance with rise in receiver's heights.

Reduction of well width in QRD design causes increase in absorption ability of the device due to thermal and viscous effect inside each well. Increase in the absorption properties of the single profile diffusive barriers by reduction of the utilized well width has already been proved. (Monazzam & Lam, 2008) On the other hand it is also should be noted that the effect of well in resonant will be limited to shorter frequency bandwidth by reduction of well width. In other word decrease in well width causes demolishing the plane wave traveling inside the wells and the effective frequency bandwidth will be narrower. In this investigation the effect of well width in parallel profile diffusive barrier is investigated. In this case 3 different parallel QRD barriers with the same QRD design in barrier number 1 and different QRD design in the roadside faces of barrier number 2 are introduced. The acoustic performance of these parallel barriers in 1/3 octave frequencies at receiver point number 1 is compared with together and also their equivalent rigid profile parallel barrier model PT in Figure 20. The number of QRDs in barrier model PGA is 3 and therefore the well width used in barrier number 2 of this setup is 12 cm, while it is 6 and 2 respectively for barrier models PHH and PII. In other word the well width in QRD used in barrier model PHH is 1/3 of that of in barrier model PGA and as one can easily see from the graph the performance of barrier model PHH is slightly higher than that of barrier model PGA. However according to Figure 20 the performance of barrier model PII with much narrower well width and of course higher absorption coefficient is lower than that of both barrier models PHH and PGA with wider well width and therefore lower absorption property. It seems reduction of well width causes smaller effective frequency bandwidth in the utilized QRDs and therefore the effective performance of the diffusive barrier with smaller bandwidth gets limited. But on the other hand the barrier model PHH with smaller well width and higher absorption property shows fairly higher performance because this special well width still provide the effect of well in resonant and also because of more wells and better distribution of the wave in front of the barrier faces, the performance in reduction of degradation effects is also still significant. Therefore one can conclude that the increase in absorption while the effect of well in resonant is not removed protects the reactive

Table 4. The overall A-weighted improvement made by barrier model PGG over barrier model PT at 16 different receiver points

Receiver No.	The A-weighted mean improvement of insertion loss(dB(A))
1	6
2	5.4
3	4.8
4	4.9
5	7.6
6	6.3
7	5.7
8	7.5
9	7
10	6.4
11	3.5
12	7.2
13	7
14	-0.5
15	5.4
16	6.7
Average (App.)	5.7

behavior of the surface with no losses in acoustic performances of reactive barriers. However, if increase in absorption coefficient destroys the effect of wells in resonance; it will also have negative effect on the QRD edge parallel barrier. The overall performance of the above mentioned parallel barrier is compared in (Fig. 21). The overall performance of barrier model PHH and PGA are

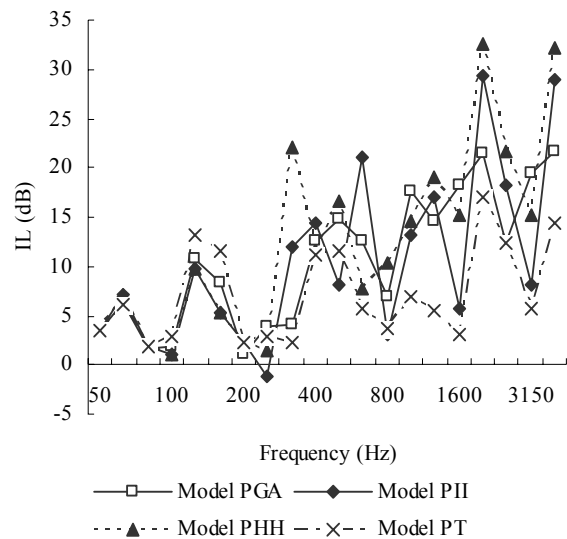

Fig. 20. Predicted frequency spectra of barrier insertion loss for barrier models PGA, PII and PHH along with their equivalent rigid parallel barrier model PT at the receiver point (-50,0)

almost the same in most receiver points and their performance is significantly higher than that of barrier model PII. The average decrease in performance by well width reduction of 12 to 2 cm is 3.5 dB (A), which confirms the above discussion on the importance of the effect of well in resonant on the overall performance of diffusive parallel barriers. A comparison is also made for the acoustic performance of barrier model PII compared to barrier model PGA at 500 Hz in wide area behind barrier number 1 in (Fig.22). By close looking to this contour graph the extent of the effect of well in resonant is revealed. The graph shows that at almost in entire field in the shadow zone the performance of parallel diffusive barrier

reduced dramatically by sharp reduction of the effect of wells in resonant in barrier model PII. The amount of average reduction is 12 dB. Therefore selection of suitable well width plays a vital role on the overall performance of the reactive parallel barriers. To give a clear picture of the entire designed profile QRD parallel barriers, their overall acoustic performance are compared in (Fig. 23). In the graph two types of receivers are introduced including the receivers with heights of lower barriers' height (receiver's height 3 m or lower) and the receivers with heights of 7.5 m or lower. At any types of receivers the overall results are averaged. As it is expected and clearly seen, none of the designed barriers could totally remove

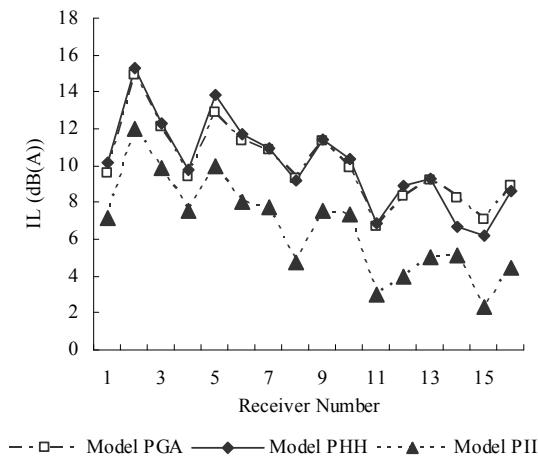

Fig. 21. The A-weighted mean insertion loss for diffusive parallel barrier models PGA, PHH and PII at 16 receiver points

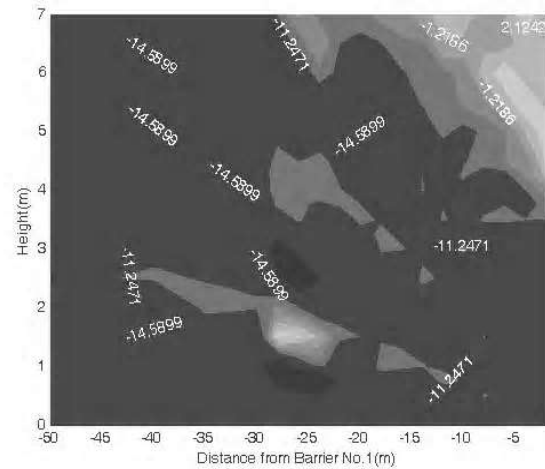

Fig. 22. The amount of reduction in insertion loss of barrier model PII compared to that of in barrier model PGA at 500 Hz in the wide field behind barrier number 1

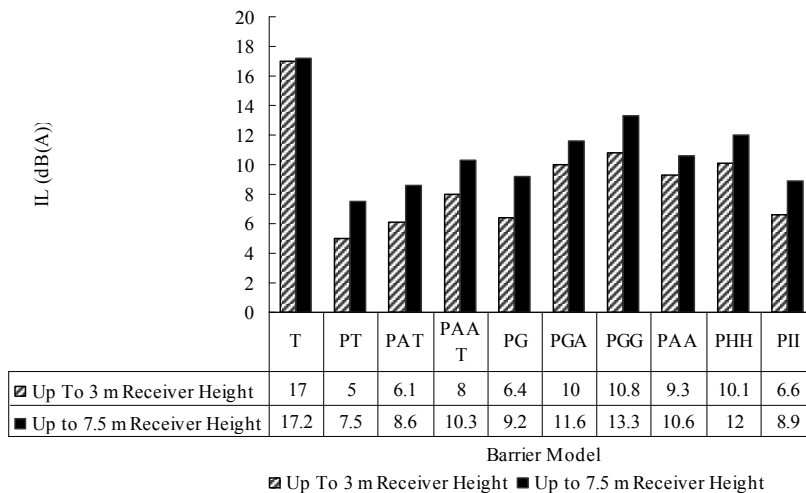

Fig. 23. The A-weighted mean insertion loss for all vertical designed profile parallel barriers along with the single vertical T shaped barrier at two different receiver categories

the multiple reflection degradation effect of parallel barriers. However among the designed barriers the best overall performance is achieved by introducing barrier model PGG. Using this parallel diffusive barrier the overall performance of the fully absorbent parallel barrier model PAAT improves by 3 dB (A) and the performance of the equivalent rigid parallel barrier improves by 5.8 dB (A). The other interesting result in the graph is that all designed profile parallel barriers have better performance in higher heights some thing is desirable in the real application. The lowest improvement is made by barrier model PII. In fact narrowing the well width in the QRD barrier removes the effects of well in resonant so that this barrier performs very similar to rigid barrier rather than a diffusive barrier.

CONCLUSION

The attenuation of sound by QRD edged vertical parallel noise barriers has been investigated using a two-dimensional boundary element model. Broadband insertion loss has been predicted over a range of representative receiver positions using an A-weighted traffic noise spectrum in 1/3-octave band from 50 to 4000 Hz. The performance of three different top surfaces; rigid; absorptive; and QRD on a set of vertical parallel profile barriers has been evaluated. The performances of QRD parallel barriers have been compared with their equivalent absorbent and rigid barriers. The results can be summarized as follows:

1. The multiple reflection effect in the vertical profile parallel barrier makes the acoustic performance of the barrier to be very frequency selective with dramatic reduction in overall acoustical efficiency on traffic noise abatement programs. Of course the performance of profile parallel barriers is also dependant to the geometry of the condition, but in the present condition and geometry the mean A-weighted reduction compared to an equivalent single profile barrier ranges between 8.3 to 16.5 dB(A) depends on receiver points, the longer the distance of the receiver from the barrier the higher reduction.
2. Utilizing absorbent elements on just top surface of barrier number 1 doesn't show a significant improvement on overall performance of the profile parallel barriers, which is due to low treated surfaces. The mean A-weighted overall improvement is predicted to be only 1 dB (A). However by treating more surfaces including the

roadside faces of barrier number 2 the performance in lower frequencies is improved and therefore the overall performance is also increased. The mean A-weighted overall improvement compared to its equivalent rigid barrier is calculated to be only 3 dB (A). In parallel absorbent barrier the improvement in near and far field including close to ground or higher heights remains almost the same.

3. Utilizing a quadratic residue diffuser with design frequency of 400 Hz on the top surface of barrier number 1 improves the performance of its equivalent rigid as well as even fully absorbent barriers. The effective frequency is above 315 Hz while in some frequencies including 800 and 1600 Hz which are the even functions of the design frequency the performance is low. This low performance is due to low reactive behavior of the diffuser in these frequencies. The overall performance of the partially diffused profile barrier in A-weighted scale is even higher than that of a fully absorbent parallel barrier because of low frequency effect of the designed QRD barrier. With introducing the designed QRD on more surfaces including roadside face of barrier number 2, the overall performance improves 5.8 dB (A) compared to its rigid equivalent barrier.

4. An interesting result in all different diffusive parallel barriers is that the performance is improved with distances and heights some thing is desirable for real applications. This results is consistent with the results of Claudio et al. (Claudio, *et al.*, 2007)

5. Among the different design frequencies tested, namely 1000, and 400 Hz, the most efficient design was found to be a QRD tuned to 400 Hz. As expected, lowering the design frequency while keeping the upper cut-off frequency constant provided higher broadband mean insertion loss in the profile parallel barriers.

6. Reducing the well width of utilized QRD on profile parallel barriers reduces the overall A-weighted insertion loss of the barriers, which is due to reducing the effect of wells in resonant. This result confirm the results of the recent work on the single profile barriers by Monazzam (Monazzam & Lam, 2008)

7. Among the designed parallel barriers the best overall performance is achieved by introducing barrier model PGG. Using this parallel diffusive barrier the overall performance of the fully absorbent parallel barrier model PAAT improves

by 3 dB (A) and the performance of the equivalent rigid parallel barrier improves by 5.8 dB (A).

It should be noted that the above results were obtained purely by numerical simulations while the environmental factors such as atmospheric turbulence are ignored in prediction models. Although the boundary element method used for the simulation has been found in previous studies to have very good accuracy when applied to QRD barriers (Monazzam, 2005), its accuracy when dealing with QRD on a parallel barrier has yet to be confirmed with measurements.

REFERENCES

- Bowlby, W. (1984). Analysis and Control of multiple reflections between parallel Traffic Noise Barrier. Ph.D dissertation, Vanderbilt University, Nashville, TN.
- Bowlby, W. and Cohn, L. (1986). A model for insertion loss degradation for parallel highway noise barriers. *J. Acoust. Soc. Am.* **80(3)**, 855-868.
- Bowlby, W. (1986). Traffic noise research needs of state highway agencies. Transportation Research Circular, Transportation Research Board, Washington, DC.
- BS EN 1793-3:1998 (1998). Road traffic noise reducing devices- Test method for determining the acoustic performance, Part 3. Normalized traffic noise spectrum.
- Claudio, C., Massimo, C. and Lucia, F. (2007). Experimental verification of the acoustic performance of diffusive roadside noise barriers. *Applied acoustics*, **68**, 1357-1372.
- Commins, D. E., Auletta, N. and Suner, B. (1988). Diffusion and absorption of quadratic residue diffusers. *Proc. I. O. A.* **10(2)**, 223-232.
- Cox, T. J. and D'Antonio, P. (2004). *Acoustic Absorber and Diffusers: Theory, design and application*. Spon Press, Taylor and Francis Group, London and N.Y., USA.
- Crombie, D.H., Hothersall, D.C. and Chandler-Wild, S.N. (1995). Multiple-edge noise barrier. *Applied Acoustic*, **44(4)**, 353-367.
- Delany, M.E. and Bazely, E.N. (1970). Acoustical properties of fibrous absorbent material. *Applied Acoustic*, **3(2)**, 105-16.
- Fujiwara, K. and Miyajima, T. (1992). Absorption characteristics of a practically constructed Schroeder diffuser of quadratic- residue Type. *Applied Acoustics* **35**, 149-152.
- Fujiwara, K. (1995). A study on the sound absorption of a quadratic- residue type diffuser. *Acustica*, **81**, 370 -378.
- Fujiwara, K., Hothersall, D.C. and Kim, C.H. (1998). Noise barriers with reactive surfaces. *Applied Acoustic*, **53(4)**, 225-72 .
- Fujiwara, K. (1990). Sound shielding efficiency of a barrier with soft surface. *Proc. Inter noise*, **90**, 343-346.
- Hajak, J.J. (1980). Performance of parallel noise barriers Yonge Street to Bayview Avenue. Ontario Ministry of Transportation and Communication, Ottawa.
- Hendricks, R. W. (1993). Field evaluation of acoustical performance of parallel highway noise barriers in California. National Research Council, Washington, DC, , Transportation Research Record 1366 .
- Hothersall, D.C., Crombie, D.H. and Chandler-Wilde, S.N. (1991). The performance of T-shape profile and associated noise barriers. *Applied Acoustics*, **32(4)**, 269-281.
- Hothersall, D.C., Crombie, D.H. and Chandler-Wilde, S.N. (1991). The performance of T-shape profile and associated noise barriers. *Applied acoustics*, **32(4)**, 269-81.
- Kurze, U.J. (1974). Noise reduction by barriers. *J. Acoust. Soc. Am.*, **55**, 504-518.
- Kuttruff, H. (1993). Sound absorption by pseudo-stochastic diffusers (Schroeder Diffuser). *Applied Acoustics*, **42**, 215-231.
- Li, K. M. and Tang S. H. (2003). The predicted barrier effects in the proximity of tall buildings. *J. Acoust. Soc. Am.* , **114 (2)**, 821-823 .
- Li, K. M., Man, P. K. and Ming, K. L. (2008). A ray model for hard parallel noise barriers in high-rise cities. *J Acoust Soc Am.*, **123(1)**, 121-32.
- Monavari, M. and Mirsaeeed, Sh. G. (2008). Ecological impact assessment of highways on national parks: Tehran – Pardis highway (Iran). *Int. J. Environ. Res.*, **2(2)**, 133-138.
- Monazzam, M. R. (2005). Application of diffuser surfaces on single profile environmental noise barriers: Evaluation, Theory and optimization. PhD Thesis, University of Salford
- Monazzam, M. R. and Lam, Y. W. (2005). Performance of profile single noise barriers covered with quadratic residue diffusers. *Applied Acoustics*, **66**, 709-730.
- Monazzam, M.R. and Lam, Y.W. (2008). Performance of T-shape barriers with top surface covered with absorptive quadratic residue diffusers. *Applied Acoustics*, **69(2)**, 93-109.
- Nelson, P.M., Abbott, P.G. and Savidge, C. (1976). Acoustic performance of the M6 noise barriers. Transport Research Laboratory Report, LR 731, Crowthorne, UK
- Slutsky, S. and Bertoni, H.L. (1998). Analysis and programs for assessment of absorptive and tilted parallel barriers. Transportation Research Record 1176, Washington.
- Tobutt, D.C. and Nelson, P.M. (1990). A model to calculate traffic noise levels from complex highway cross – sections. Transport Research Laboratory Report RR245, Crowthorne, UK.
- Watts, G. R. and Godfrey, N. (1999). Effects on roadside noise levels of sound absorptive materials in noise barriers. *Applied Acoustics*, **58**, 385-402 .
- Watts, G.R. (1996) Acoustic performance of parallel traffic noise barrier. *Applied Acoustic*, **47(2)**, 95-119.
- Wu, T., Cox, T. J. and Lam, Y. W. (2001). From a profiled diffuser to an optimized absorber. *J. Acoust. Soc. Am.*, **119(6)**, 3064-3070.