



The attitude of Horand's villagers toward wildlife and determinants of human-wolf conflict, East Azerbaijan, Iran

Mortaza Nematpour, Nader Habibzadeh*

Department of Environmental Science, Tabriz Branch, Islamic Azad University, Tabriz, Iran

* Corresponding author's E-mail: habibzadeh@iaut.ac.ir

ABSTRACT

The study aimed to investigate the attitudes of the villagers of Horand County, East-Azerbaijan about wildlife species with the focus on eight species and to determine the main causes of their conflict with the gray wolf. The data was collected using a semi-structured questionnaire during the spring and summer 2016. In 37 randomly selected villages, households were categorized as farmer-shepherd, shepherd, or farmer. In each village, 10% of the households belonging to each of the three groups were randomly selected and an interview was conducted with senior households. The results exhibited that three carnivorous species i.e. bear, hyaena and gray wolf were classified as problematic species along with boar, but the people were negative in their views toward hyaena and jackal than gray wolf and bear. The intensity of human-wolf conflict was positively influenced by an increase in respondents' number of income sources, as well as by livestock disease-related losses. However, respondents' increased awareness of wildlife was correlated with the decreased intensity of the human-wolf conflict. These results suggest that biodiversity conservation programs should prioritize attention to shepherd-farmers in managing the human-wolf conflict in Horand County.

Key words: Conservation attitudes, East-Azerbaijan, Horand County, Wildlife-human conflict, Gray wolf.

INTRODUCTION

Human-wildlife conflict is currently a major challenge in the conservation and management of wildlife. Therefore, controlling and mitigating the negative effects of animal-human conflict is one of the issues ahead in the protection of various species (Madden 2004). The persecution of carnivores by some due to domestic livestock depredation contrasts with others' desire to protect carnivores and has led to carnivore-human conflict (Woodroffe *et al.* 2005). The extent of the actual damage caused by wildlife and the people's view toward the livestock losses compromise the dimensions of people's hostility towards wildlife (Suryawanshi *et al.* 2013). Livestock depredation is a conservative and economic concern. Having a consolidate knowledge about spatial distribution and factors affecting domestic depredation (Suryawanshi *et al.* 2013), along with the study of people's attitude (Habibzadeh, 2016) are beneficial on effective management human-carnivores conflict. The tolerance of people in the face of animal-induced damages is different and depends on many factors, including religious beliefs, income and educational level, characteristics of carnivores and people's culture (Mishra 1997; Liu *et al.* 2011).

Gray wolf (*Canis lupus*), one of the most widely spread carnivorous species, has a high adaptation to living in a variety of habitats (Mech & Boitani 2004). The widespread distribution and the ability to feed on the numerous preys, has contributed to the wolves-human conflict where the destruction of habitats and the depletion of natural preys are taking place (Treves & Karanth 2003; Loe & Röskaft 2004). Such a condition in anthropogenic landscapes of Iran has financial consequences (Behdarvand *et al.* 2014) and the wolf attack on human in the rural communities (Behdarvand & Kaboli 2015) as well as affecting the conservation status of the species (Ahmadi *et al.* 2013; Behdarvand *et al.* 2014). Wolves have suffered the most severe harassments in many parts of Iran due to increased conflicts with villagers (Ziaie 2011). However, there are ethical and scientifically supported

ecological reasons to protect wolves (Mech & Peterson 2003; Ripple & Beschta 2004; Lute *et al.* 2016). Wolf, as a keystone species, has huge impacts on the landscape of its own habitat. Its disappearance in nature leads to extinction cascades throughout the associated ecosystems (Ripple & Beschta 2004; Fortin *et al.* 2005; Hebblewhite *et al.* 2005).

Many studies show the willingness of young, educated, urban residents and women to protect wolves, but all of these studies indicate that there is a severe antagonism toward wolves among livestock and crop producers who dwell close to wolves' habitats (Kaltenborn *et al.* 1999; Williams *et al.* 2002; Naughton-Treves *et al.* 2003). Accordingly, without compensation measures in the case of these conflicts, it seems that most of the cost of the wolf conservation is likely to be returned to the local communities such as shepherds (Muhly & Musiani 2009). Domestic animals represent the highest percentage of wolves' diet in areas where the human population has a high density (Eggermann *et al.* 2011; Llaneza *et al.* 2012). Livestock husbandry is the main occupation among people in Horand County. The diversity and complexity of the habitat in the Horand area, although creating favorable habitats for the wolves, a juxtaposition of the natural and agricultural lands which increase livestock depredation probability is a major obstacle for applying an effective management plan to reduce the incompatibility of human and wolf. There are frequent reports of the wolf losses in this region indicating an increase in the intensity of the human-wolf conflict (the livestock reported lost to gray wolf between 2006 and 2016 in the Horand region indicates an annual average of 12.81 small livestock and 1.1 cow; unpublished reports of Official Department of Environment in East-Azerbaijan). The potential establishment of the wolf-human coexistence in the vulnerable rural communities in Horand County must recognize such realities and make fundamental investments in strategies to reduce these conflicts. In the present study, we discerned the views of villagers in Horand region about wildlife species with focusing on eight species (gray wolf, bear (*Ursus arctos*), jackal (*Canis aureus*), hyaena (*Hyaena hyaena*), fox (*Vulpes vulpes*), least weasel (*Mustela nivalis*), badger (*Meles meles*) and wild boar (*Sus scrofa*)) and ascertained the main determinates of the wolf-human conflict to provide a base knowledge for conflict management.

MATERIALS AND METHODS

This study was conducted in Horand County in one of the 12 counties of the East-Azerbaijan Province in Northwest Iran, including the Dickleh, Dodangeh, and Chardangeh regions. This area, which is dominated by the agro-ecosystem landscape, comprises diverse habitats of agricultural-land types, pastures, and human settlements. Rain-fed crops are grown in the majority of the region. The rangelands have been roamed by local shepherds throughout the year except on winter days with harsh weather conditions. After crop harvesting, some villagers use either their farms to feed the livestock or lease them to other livestock producers. The pastures are governed by the government, follows a plan that was prepared in cooperation with local communities and is based on a traditional grazing regime that dates back generations. 34 villages out of the 104 from these three regions were randomly selected in QGIS (Fig. 1). The data was collected using a semi-structured questionnaire based on the Dickman (2008) method during the spring and summer 2016. Questions were categorized into two basic categories. The first was concerning to the socio-economic characteristics of the respondents based on self-reported livestock losses over the last year and sources of their income, and the second was related to people's attitudes toward wildlife species, with a focus on eight species that were more likely to lift conflict. In order to complete a semi-structured questionnaire, at first, a list categorizing households based on their job as shepherd-farmer, shepherd, and farmer was prepared for each village employing the data acquired from the village's leader. Then, in each village, 10% of households (Kangwana 1993; Maddox 2002) from each aforementioned category were randomly selected. After identifying the target households, only the head of the household (the 18-year olds who playing an essential role in his/her family's livelihood) was interviewed.

To assess whether the respondents categorized gray wolf into a distinct group of other wildlife species, especially carnivores, the free list of species names was used (Dickman 2008) through the multi-dimensional scaling approach based on the relative distance between the species in the list. The respondents were shown the picture cards of the eight species and were asked whether or not they recognize the species, and if they misidentified every species, then they were told the correct name of the species. If they knew which species it was, they were then asked whether the species was seen around their household (defined as the within one-day patrol around the village), and if so, they were asked to classify them as either posing no problem, a small problem or a large problem.

A hierarchical cluster approach was used to examine which species tended to have the similar conflict scores (according to Dickman 2008). The conflict scores were also compared with the respondents' views on the desired future carnivore population trends, in order to evaluate whether people were positive, consistent, or negative in their views toward every eight focal species (according to Dickman 2008; Table 1). The one-sample Kolmogorov-Smirnov test was employed for normality. If so, the parametric statistics were used, otherwise, non-parametric alternatives were applied. The Levene's test was employed to check equality of variances and the chi-squared test for independence to assess whether the two categorical variables were related to each other. It was also true for the Mann-Whitney U test to compare the median differences in a continuous variable between two independent groups; the Kruskal-Wallis H test for comparing differences between three or more groups; the paired samples *t*-test to compare the means of a variable measured from the same group of people on two different occasions; the Wilcoxon's signed ranks test as the non-parametric alternative to the paired samples *t*-test to compare variation in a non-normally distributed variable between two points in time; the univariate analysis of variance (ANOVA) to compare the mean scores of a continuous variable between two or more groups; Pearson's correlation to explore the strength of the relationship between two normally distributed continuous variables; and Spearman's rank for the non-parametric correlation analysis. All these tests were conducted using the Statistical Package for Social Sciences (SPSS) PC version 18.0 (SPSS Inc., Chicago, USA). Generalized linear modeling (GLM) procedure using glmulti (Calcagno & de Mazancourt 2010) in the RStudio software environment (RStudio Team 2016) was used to determine which factors were retained in the final model with the lowest Akaike's information criterion (AIC) score and to describe best the intensity of the human-wolf conflict.

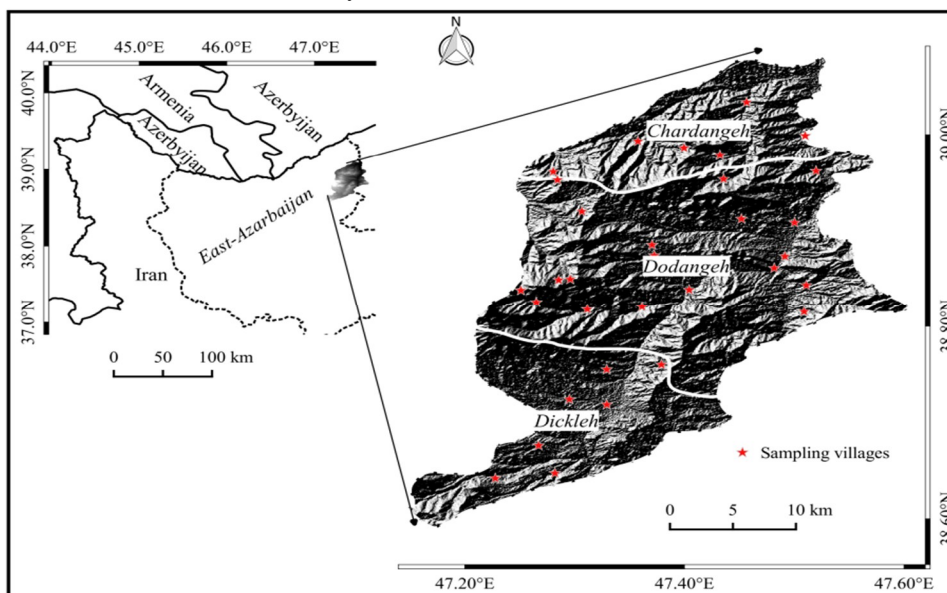

Fig. 1. The location of the study area in East-Azerbaijan, Iran.

Table 1. Comparison of respondents' reported problems with eight focal species, and their stated desired trend for that species, to determine their views towards that species.

Conflict intensity with species of interest	Desired population trend for that species			
	Increase	Stay the same	Decrease	Disappear
Big problem	Positive	Positive	Consistent	Consistent
Small problem	Positive	Positive	Consistent	Negative
No problem	Positive	Consistent	Negative	Negative

RESULTS

Respondent characteristics

Overall, 95 interviews were conducted in 34 villages in the three parts of Horand county. 47.7% of the interviewees were in the Dodangeh, while 21.1% and 31.6% in the Dickleh and Chardangeh respectively. 66.3% of the interviewees were shepherd-farmer, while 21.1% and 12.7% were shepherd and farmer, respectively (Fig. 2).

The life span of respondents at their present location indicated relatively long average tenure (mean = 46.9 years), with a large range (18-78 years). The length of the residence period was significantly different between the three parts ($\chi^2_{(2)} = 11.45$, $p = 0.003$), with the Chardangeh interviewees usually having been settled for 41.3 (± 8.14) years, compared to an average of 48.42 (± 11.16) and 51.70 (± 13.92) years for the Dodangeh and Dickleh interviewees, respectively ($z = -2.59$ $p = 0.01$; $z = -3.09$ $p = 0.002$). The number of income resources ranged from 1 to 3 (mean \pm SD = 1.65 \pm 0.72), agricultural occupations represented a particularly important asset, (67.4% of interviewees), followed by the livestock husbandry, working in cities, and hunting accounted for 50.5%, 30.5%, and 6.3%), respectively.

The respondents from the Chardangeh were significantly dependent on the income from the agricultural crops relative to livestock products ($\chi^2_{(1)} = 5.70$ $p = 0.02$), while interviewees of Dodangeh and Dickleh's people dependency on both types of agricultural products and livestock were equal ($\chi^2_{(1)} = 0.01$ $p = 0.92$; $\chi^2_{(1)} = 0.05$ $p = 0.83$).

The livestock selling was the main cause of livestock loss, accounted for 48.5 %, followed by losses due to carnivores, diseases, slaughtering, gift, and other factors, respectively (Fig. 3).

Although there was not a significant difference between the total number of livestock lost due to carnivores between shepherds and shepherd-farmers ($F = 0.029$, $p = 0.86$), this variable varied significantly between the three parts of the county ($F = 3.70$, $p = 0.03$). The difference between the Dickleh and Chardangeh was significant; the Dickleh had 67.6% of the most livestock loss over the past year compared to the Chardangeh (9.5%) and Dodangeh (23%).

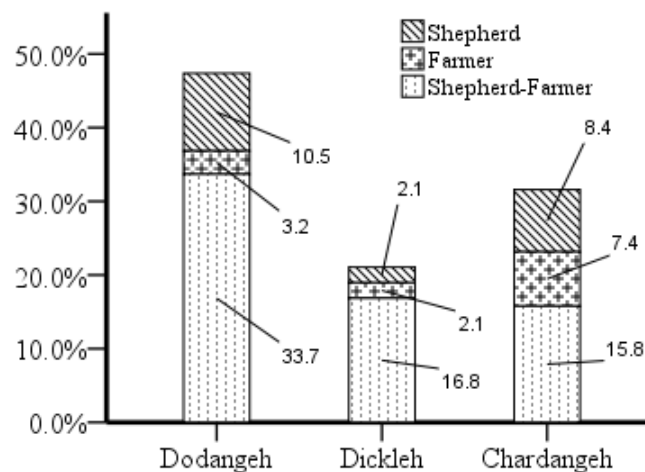

Fig. 2. Percentage of the respondents with different occupations across three parts in Horand County, Iran.

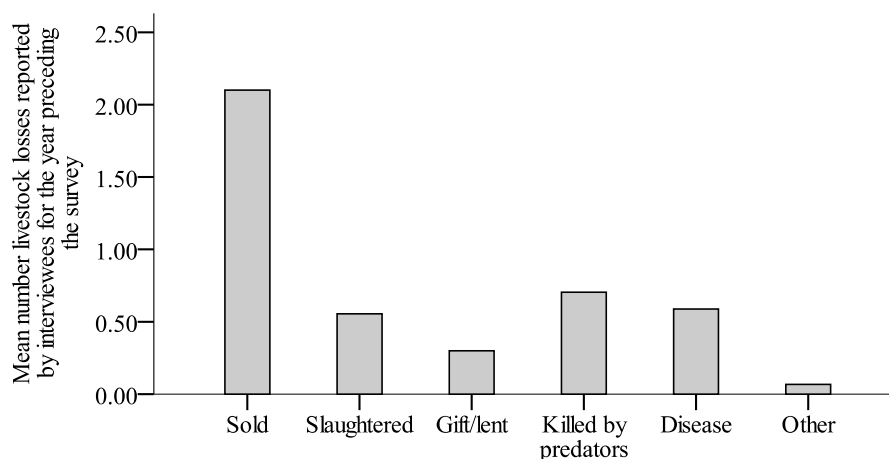

Fig. 3. Mean number of reported livestock lost due to different causes, for the year preceding the survey.

People’s knowledge of wildlife

In general, the names of 3-13 species of wildlife, with an average of 5.9 and totally 21 species of wildlife were mentioned by the respondents in the free listing of wildlife species. The multidimensional scaling indicated that the species of gray wolf, bear, rabbit, and boar were considered in a distinct group than other species (Fig. 4).

There was no difference in the number of listed species by the different occupational groups ($\chi^2_{(2)} = 0.79$ $p = 0.67$); but there were significant differences between the three parts ($\chi^2_{(2)} = 6.9$ $p = 0.03$), this difference was significant between the Dodangeh and the Dickleh ($z = -2.54$ $p = 0.01$).

The respondents correctly identified an average of 11.3 (7 to 14) of the 14 species of wildlife pictures. Although the correctly species recognition amongst the different occupational groups exhibited a significant difference ($\chi^2_{(2)} = 6.09$ $p = 0.04$), there was no difference between the interviewees of the different parts ($\chi^2_{(2)} = 0.73$, $p = 0.62$). The shepherd group identified significantly the wildlife species in comparison with the farmer ($z = -2.04$ $p = 0.04$) and shepherd-farmer groups ($z = -2.3$ $p = 0.02$). The roe deer that identified correctly by only 35% of people was less known than the rest of the species.

When the interviewees asked to list which one of 14 species described using their photographs could be seen within one day’s walking surrounding the villages, the responses were varied between the different occupational groups ($\chi^2_{(2)} = 10.06$, $p = 0.007$), whereas there was no difference between the three parts ($\chi^2_{(2)} = 3.23$ $p = 0.19$). There was significant variation amongst the farmers than the two other occupational groups ($z = -2.3$ $p = 0.02$; $z = -3.2$ $p < 0.01$).

When asked about their feelings toward gray wolf, the majority of the interviewees described it as a beautiful, ecologically important, dangerous, scary creature. Surprisingly, gray wolf was classified as an intolerable species despite mentioning its usefulness (Fig. 5).

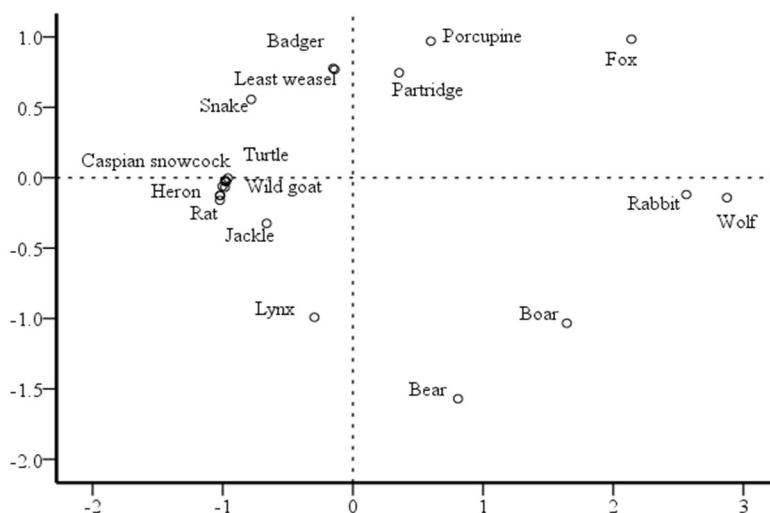

Fig. 4. Multidimensional plot showing the relative distance between species in free-lists.

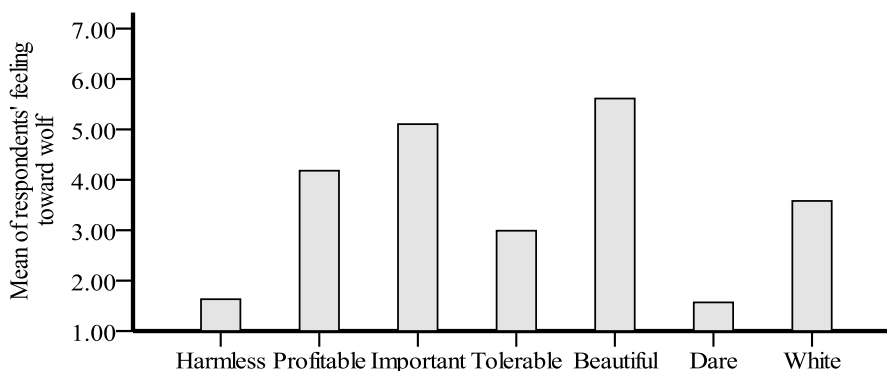

Fig. 5. Interviewee’s feelings regard to the gray wolf in terms of various words.

Assessing human-wildlife conflict and consistency of attitudes

The mean of conflict scores given to the eight focal species (1.4 ± 0.33) had a significant difference between the different species ($\chi^2_{(7)} = 159.87$ $p < 0.001$); the intensity of human-bear conflict was the highest, whereas was the lowest toward fox (Fig. 6). Although no significant difference was found between the four species with the big problem such as the three focal carnivore species i.e. bear, hyena, and gray wolf as well as boar ($\chi^2_{(3)} = 5.67$ $p = 0.13$), however, the intensity of the hostility between this group and those with low incompatibility score (fox, jackal, least weasel, and badger) exhibited a significant difference ($\chi^2_{(1)} = 36.0$, $p < 0.001$). The conflict level between people and the eight focal species displayed a momentous difference between three parts of the county ($\chi^2_{(2)} = 19.15$ $p < 0.001$) with a significant difference between Dodangeh (mean = 1.3, SD = 0.56) and Dickleh (mean = 1.83 SD = 0.54; $z = -3.5$ $p < 0.01$) as well as between Dickleh and Chardangeh (mean = 1.18 SD = 0.35; $z = -4.02$ $p < 0.001$). There were also differences amongst the occupational groups ($\chi^2_{(2)} = 7.5$ $p = 0.02$) apparently between farmer and shepherd-farmer ($z = -2.5$ $p = 0.01$). However, no significant difference was found between the respondents on the reported conflict scores for the each eight species ($\chi^2_{(92)} = 92.00$ $p = 0.48$). A hierarchical cluster analysis on the reported conflict scores for every eight focal species revealed two distinct species clusters in terms of their degree of perceived conflict with respondents (Fig. 7). The first cluster consisted of the lower conflict-scoring species including fox, jackal, least weasel, and badger, while the second one contained all species cited as the species make the big problem.

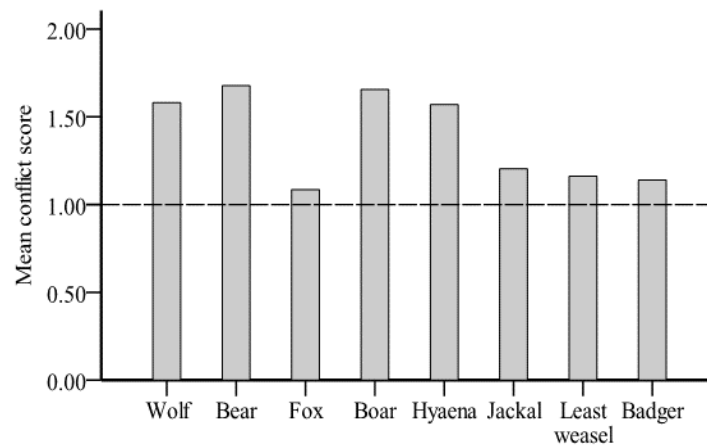

Fig. 6. Mean conflict scores assigned by respondents to the species exhibited in the study. The dotted line displays the mean across all species.

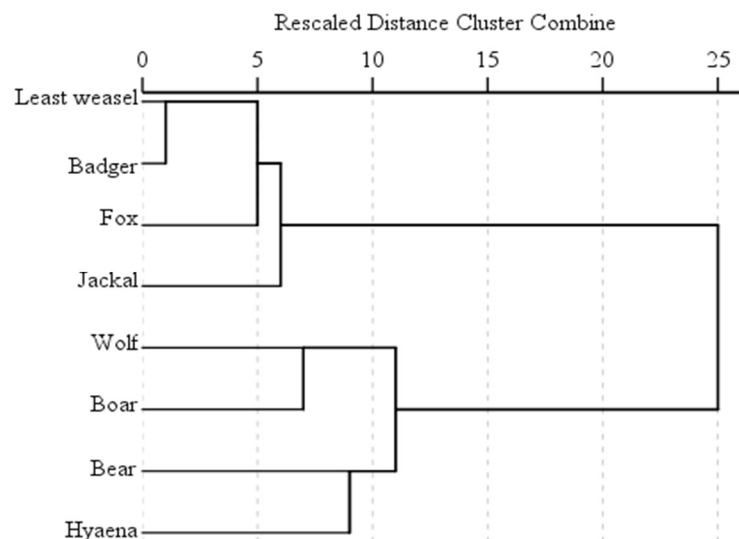

Fig. 7. Dendrogram produced through hierarchical cluster analysis, with two resultant clusters based on average distance of conflict scores between groups.

Hyaena is capable of coexist closely with people by feeding on readily available livestock and anthropogenic food where the natural prey is very low (Yirga *et al.* 2015). Therefore, it is not surprising that it has the potential to make the main problems for people. Conflict with hyaena was reported as high, with a significant level in the view of farmer-shepherd group compared to farmer ($z = -2.75$ $p = 0.006$) and shepherd ($z = -2.57$ $p = 0.01$) ones.

Once asking people to declare which species making the big problem was observed within one day's walk around the villages, the respondents declared no observations of hyaena, but gray wolf, bear, and boar were observed more frequently. The majority of the respondents asserted that they have no information on the population trends except for gray wolf and boar which were reported to be increased. There was a significant difference concerning to the population trends between the occupational groups ($\chi^2_{(2)} = 20.88$ $p < 0.001$) and the three parts of county ($\chi^2_{(2)} = 9.12$ $p = 0.01$). Surprisingly, a large number of the respondents exhibited tendency to be increased population of all species.

The stated desired population trends exhibited a significantly difference between the three parts ($\chi^2_{(2)} = 13.3$ $p = 0.001$) but this was not the case for the occupational groups ($\chi^2_{(2)} = 5.9$ $p = 0.06$). The respondents from Dickleh wished the eight focal species to be increased in comparison with the other parts i.e. Dodangeh ($z = -3.01$ $p = 0.003$) and Chardangeh ($z = -3.13$ $p = 0.002$).

Over half of the respondents from the different occupational groups wished to be increased population of all the species, consistent with the magnitude of the problem previously declared for that species.

The level of consistency varied significantly between the species ($\chi^2_{(7)} = 21.94$ $p = 0.003$), with people far less consistent in the relationship between the problems and desired trends for foxes, jackals, least weasels, and badgers than for bears and hyaenas. How positively and negatively people were about the eight focal species varied also significantly between the different species ($\chi^2_{(7)} = 22.40$ $p = 0.002$; $\chi^2_{(7)} = 19.86$ $p = 0.006$), with people particularly positive towards bears, foxes, boars, least weasels, and badgers as well as negative towards jackals and hyaenas in terms of the desired population trends compared to how problematic they were actually considered to be.

Key determinants of the human-wolf conflict

The level of reported conflict with gray wolf varied significantly between the different respondents ($\chi^2_{(94)} = 5.8$ $p = 0.48$). Initial exploratory tests revealed that the magnitude of the reported gray wolf conflict varied significantly between different occupational groups ($\chi^2_{(2)} = 5.8$ $p = 0.006$); with farmer-shepherd group tending to be less tolerant than farmer group ($t = -2.39$ $n = 75$ $p = 0.02$).

The gray wolf conflict level also varied between different age groups ($\chi^2_{(26)} = 50.3$ $p = 0.003$), with old people more tolerant ($r = 0.18$ $n = 95$ $p = 0.04$) than younger ones. A significant positive relationship was also found with the residence time of the respondents in the villages ($r = 0.19$ $n = 95$ $p = 0.03$). The primary income sources seemed to affect the magnitude of the reported conflict ($F = 7.11$ $df = 2$ $p = 0.001$), with least hostility amongst people who gain their income from livestock ($t = -2.01$ $n = 94$ $p = 0.04$) and also those with more versatile income ($r = 0.29$ $n = 95$ $p = 0.003$). The reported conflict levels were also increased with low level of people's knowledge about wildlife ($r = -0.35$ $n = 95$ $p < 0.001$), number of livestock lost by carnivores ($r = 0.19$ $n = 83$ $p = 0.04$) and disease ($r = 0.32$ $n = 83$ $p = 0.002$).

Clearly, however, many of these factors were correlated with one another, e.g., the low level of conflict declared by farmers may, in fact, reflect the level of their high income or less encountering with gray wolf. The relative importance of different factors examined relating to the mean conflict score by GLM analysis revealed that the original model (a model that included all variables) had an AICc value of 202.6, while the final model (the best-fitted model) AICc value was 194.4.

This model retained the people's knowledge level of wildlife species, the number of livestock reportedly lost by disease, and the number of sources of income as the most important variables influencing the magnitude of reported conflict with gray wolf (Table 2).

Table 2. Final variables which contributed to the general linear model with the lowest AIC score to examine conflict with the gray wolf.

Source	Variable coefficients	Standard error	t	Sig.
Intercept	2.74	0.52	5.28	< 0.001
People's knowledge of wildlife species	-2.33	0.52	-4.46	< 0.001
Number of sources of income	0.62	0.12	5.13	< 0.001
Number of livestock lost by disease	0.13	0.06	1.9	0.045

DISCUSSION

As the level of the human-wildlife conflict has substantial consequences on wildlife populations and its understanding has been important for biodiversity conservation, it is imperative to shed light the key determinants of this conflict. In the present study, the three carnivores i.e. bear, hyena, and gray wolf along with boar were ranked as significantly more problematic than the other species. One of the unexpected results in this study was that people had a more negative view toward hyena and jackal compared to gray wolf and bear. It is a fact that some antagonistic behaviors of human derive from their appearances or dislike of their behavior (Dickman 2008); although this factor, along with the high reported level of hostility for hyena might be considered a reason for making the negative perception of the people toward this species, important for further studies. This is not entirely clear for Jackal with a low level of conflict score.

The study of the interactions of local people and predators help to advise more effective predator management (Majić & Bath 2010). It has been pointed out that conserving the wildlife habitat sources especially their natural preys reduce the human-wildlife conflict. Thus, conservationists have to take some steps to protect the main preys as a momentous dimension of species habitat in order to de-escalate the human-wildlife conflict. The initial analysis exhibited that the shepherd-farmer group had the highest degree of hostility toward gray wolf than the framers, in agreement with Western (1989), but not with Dickman (2008). However, the fact that the occupation was not considered as an effective variable in the final model, exhibited that the different hostile levels between the occupational groups in this study is due, to the fact that the livelihood of the shepherd-farmer group to the products variety (livestock and agriculture), which entered the final model as an important variable, increased the likelihood of their encounter with the studied species (both carnivorous and boar), leading to a negative view of them toward gray wolf. Although with the increased number of the income sources, there is a reduced inconsistency with wolf due to the fact that this reduces the vulnerability of a household to the wolf depredation or other unpredictable incidents (Naughton-Treves 1997; Cutter *et al.* 2000), inconsistent with our finding in Horand County. One of the unsurprising results of the study was that the intensity to the human-wolf conflict was reduced by an increased awareness of wildlife species, in agreement with Biggs (1988) and also Ericsson & Heberlein (2003). Lost due to diseases was another key factor for the antipathy toward gray wolf. The increase in disease-related losses raise costs of maintenance for the livestock owners who likely lose even a small amount of livestock because of wolves. Therefore, these have a synergetic effect and exacerbate their economic troubles that, in turn, make those people not tolerate the presence of wolves in the region and exhibit high conflict with them. One of the main factors influencing a person's vulnerability is the potential reversibility to the initial condition after an incident (Turner *et al.* 2003). The fragile rural economy and the lack of compensation systems within the villages of the study area make it very difficult for people to return to the initial point.

The results exhibited that the people who works on livestock and farms and faced to the enormous livestock losses caused by diseases, had the most inconsistency with gray wolf. Therefore, paying more attention to the shepherd-farmers in managing the wolf-people conflict in Horand County should be a priority of biodiversity conservation programs. A quick assessment of households with such key factors can help identifying the target villages in terms of conflict and implementation of measures to reduce the conflict in such areas. Based on these results, the potential approach to reducing the level of hostility toward gray wolf is to reduce the livestock lost to diseases and to increase opportunities for the people involving to livestock activities than those who involve simultaneously to the livestock and agriculture.

The human-wildlife conflict which is shaped by more complex, interrelated drivers can be more addressed by understanding clearly the source, magnitude, and consequences of the conflict (Larson *et al.* 2016). However, the identified factors here shed light the parts of Horand County where the efforts and the conflict resolution strategies should be initiated. Paying more attention to the shepherd-farmers of Horand County who suffer from livestock losses due to the diseases, should be a priority of biodiversity conservation programs in managing the wolf-people

conflict. According to the results obtained by Naderi (2017), the farmers in Ardabil City who in particular, produce the irrigated crops, are faced to the highest risk of wolf attack on livestock and human. Apparently, livestock husbandry beside the farm fields can bring wolves in more regular contact and increases depredation rate on livestock.

While it may be reasonable to suppose that the diminishing public tolerance of bears occurs as a result of agricultural damage and livestock depredation (Can & Togan 2004; Karamanlidis *et al.* 2011; Rigg *et al.* 2011), the robustness of negative attitudes toward species as hyena and jackal, despite little to no actual depredation, proves that effective conflict resolution needs long-term work and requires a broader strategy than just reducing the immediate costs of living alongside the carnivores.

Authors' contribution

Mortaza Nematpour performed the experiment and data gathering. Nader Habibzadeh conceived and designed the experiments, performed the experiments, analysed the data, prepared figures and tables, authored and reviewed drafts of the paper, approved the final draft.

REFERENCES

- Ahmadi, M, Kaboli, M, Nourani, E, Alizadeh, SA & Ashrafi, S 2013, A predictive spatial model for gray wolf (*Canis lupus*) denning sites in a human-dominated landscape in western Iran. *Ecological Research*, 28: 513-521.
- Behdarvand, N & Kaboli, M 2015, Characteristics of gray wolf attacks on human in an altered landscape in the west of Iran. *Human Dimensions of Wildlife*, 20: 112-122.
- Behdarvand, N, Kaboli, M, Ahmadi, M, Nourani, E, Salman Mahini, A & Asadi Aghbolaghi, M 2014, Spatial risk model and mitigation implications for wolf-human conflict in a highly modified agroecosystem in western Iran. *Biological Conservation*, 177: 156-164.
- Biggs, JR 1988, Reintroduction of the Mexican wolf into New Mexico - An attitude survey. M.Sc. Thesis, New Mexico State University, 66 pages.
- Calcagno, V & de Mazancourt, C 2010, glmulti: an R package for easy automated model selection with (generalized) linear models. *Journal of Statistical Software*, 34: 1-28.
- Can, OE & Togan, I 2004, Status and management of brown bears in Turkey. *Ursus*, 15: 48-53.
- Cutter, S, Mitchell, J & Scott, M 2000, Revealing the vulnerability of people and places: A case study of Georgetown County, South Carolina. *Annals of the Association of American Geographers*, 90: 713-737.
- Dickman, AJ 2008, Key determinants of conflict between people and wildlife, particularly large carnivores, around Ruaha National Park, Tanzania. PhD Dissertation, London University College, London, UK, 373 pages.
- Eggermann, J, da Costa, G.F, Guerra, AM, Kirchner, WH & Petrucci-Fonseca, F 2011, Presence of Iberian wolf (*Canis lupus signatus*) in relation to land cover, livestock and human influence in Portugal. *Mammalian Biology*, 76: 217-221.
- Ericsson, G & Heberlein, TA 2003, Attitudes of hunters, locals, and the general public in Sweden now that the wolves are back. *Biological Conservation*, 111: 149-159.
- Fortin, D, Beyer, HL, Boyce, MS, Smith, DW, Duchesne, T & Mao, JS 2005, Wolves influence elk movements: behavior shapes a trophic cascade in Yellowstone National Park. *Ecology*, 86: 1320-1330.
- Habibzadeh, N 2016, Key determinants of human-wolf (*Canis lupus*) conflict in Shabestar's villages of East Azerbaijan Province. *European Journal of Wildlife Research*, 62: 199-202.
- Hebblewhite, M, White, CA, Nietvold, CG, McKenzie, JA, Hurd, TE, Fryxell, JM, Bayley, SE & Paquet, PC 2005, Human activity mediates a trophic cascade caused by wolves. *Ecology*, 86: 2135-2144.
- Kaltenborn, BP, Bjerke, T & Vittersø, J 1999, Attitudes toward large carnivores among sheep farmers, wildlife managers, and research biologists in Norway. *Human Dimensions of Wildlife*, 4: 57-73.
- Kangwana, KF 1993, Elephants and Maasai: Conflict and conservation in Amboseli, Kenya. PhD Dissertation, University of Cambridge, Cambridge, UK, 256 pages.
- Karamanlidis, AA, Sanopoulos, A, Georgiadis, L & Zedrosser, A 2011, Structural and economic aspects of human-bear conflicts in Greece. *Ursus*, 22: 141-151.
- Larson, LR, Conway, AL, Hernandez, SM & Carroll, JP 2016, Human-wildlife conflict, conservation attitudes, and a potential role for citizen science in Sierra Leone, Africa. *Conservation & Society*, 14(3): 205-217.

- Liu, F, Mcshea, WJ, Garshelis, DL, Zhu, X, Wang, D & Shao, L 2011, Human-wildlife conflicts influence attitudes but not necessarily behaviors: factors driving the poaching of bears in China. *Biological Conservation*, 144: 538-547.
- Llaneza, L, Lopez-Bao JV & Sazatornil, V 2012, Insights into wolf presence in human-dominated landscapes: the relative role of food availability, humans and landscape attributes. *Diversity and Distributions*, 18: 459-469.
- Löe, J & Roskaft, E 2004, Large carnivores and human safety: A review. *AMBIO: A Journal of the Human Environment*, 33: 283-288.
- Lute, ML, Navarrete, CD, Nelson, MP & Gore, ML 2016, Moral dimensions of human-wildlife conflict. *Conservation Biology*, 30: 1200-1211.
- Madden, F 2004, Creating coexistence between humans and wildlife: global perspectives on local efforts to address human wildlife conflict. *Human Dimensions of Wildlife*, 9: 247-257.
- Maddox, TM 2002, The ecology of cheetahs and other large carnivores in a pastoralist-dominated buffer zone. PhD Dissertation, Department of Anthropology, University of London, London, UK, 372 pages
- Majić, A & Bath, A 2010, Changes in attitudes toward wolves in Croatia. *Biological Conservation*, 143: 255-260.
- Mech, LD & Boitani, L 2004, Grey wolf. In: *Canids: Foxes, wolves, jackals and dogs status survey and conservation action plan* (eds. Sillero-Zubiri, C., M. Hoffmann, and D.W. Macdonald). Pp. 124-129. Gland, Switzerland: IUCN/SSC Canid Specialist Group.
- Mech, LD & Peterson, RO 2003, Wolf-prey relations. In: *Wolves: behavior, ecology, and conservation* (eds. LD, Mech and L, Boitani). The University of Chicago Press, pp. 131-157.
- Mishra, C 1997, Livestock depredation by large carnivores in the Indian Trans-Himalaya: conflict perceptions and conservation prospects. *Environmental Conservation*, 24: 338-343.
- Muhly, TB & Musiani, M 2009, Livestock depredation by wolves and the ranching economy in the Northwestern US. *Ecological Economics*, 68: 2439-2450.
- Naderi, M 2017, Risk mapping of wolf (*Canis lupus*) attacks on human and livestock in Ardabil Province by spatial modeling using Maximum Entropy (MaxEnt) method. *Iranian Journal of Applied Ecology*, 6: 15-27.
- Naughton-Treves, L 1997, Farming the forest edge: vulnerable places and people around Kibale National Park, Uganda. *Geographical Review*, 87: 27-46.
- Naughton-Treves, L, Grossberg, R & Treves, A 2003, Rural citizens' attitudes toward wolf depredation and compensation. *Conservation Biology*, 17: 1500-1511.
- Rigg, R, Findo, S, Wechselberger, M, Gorman, ML, Sillero-Zubiri, C & Macdonald, DW 2011, Mitigating carnivore-livestock conflict in Europe: lessons from Slovakia. *Oryx*, 45: 272-280.
- Ripple, WJ & Beschta, RL 2004, Wolves and the ecology of fear: can predation risk structure ecosystems? *Bioscience*, 54: 755-766.
- RStudio Team 2016, RStudio: Integrated development for R. RStudio, Inc., Boston, MA URL <http://www.rstudio.com>. Accessed on March 18, 2016.
- Suryawanshi, KR, Bhatnagar, YV, Redpath, S & Mishra, C 2013, People, predators and perceptions: patterns of livestock depredation by snow leopards and wolves. *Journal of Applied Ecology*, 50: 550-560.
- Treves, A & Karanth, KU 2003, Human-carnivore conflict and perspectives on carnivore management worldwide. *Conservation Biology*, 17: 1491-1499.
- Turner, BL, Kasperson, R, Matson, PA, McCarthy, J, Corell, L, Christensen, N, Eckley, J, Kasperson, A, Luers, M, Martello, C, Polsky, PA & Schiller, A 2003, A framework of vulnerability analysis in sustainable science. *Proceedings of the National Academy of Science of the United States of America*, 100: 8074-8079.
- Western, D 1989, Conservation without parks: wildlife in the rural landscape. In: *Conservation for the twenty-first century* (eds. D, Western, and MC, Pearl). Oxford University Press, UK, pp. 158-165.
- Williams, CK, Ericsson, G & Heberlein, TA 2002, A quantitative summary of attitudes toward wolves and their reintroduction (1972-2000). *Wildlife Society Bulletin*, 30: 575-584.
- Woodroffe, R, Thirgood, SJ & Rabinowitz, A 2005, *People and wildlife, conflict or co-existence*. Cambridge University Press, Cambridge, UK, 516 pages.
- Yirga, G, De Iongh, HH, Leirs, H, Gebrehiwot, K, Deckers, J & Bauer, H 2015, Food base of the spotted hyena (*Crocuta crocuta*) in Ethiopia. *Wildlife Research*, 42: 19-24.
- Ziaie, H 2011, *A field guide to the mammals of Iran*. Iranian Wildlife Center, Tehran, Iran (In Persian), 426 pages.

دیدگاه روستاییان نسبت به حیات وحش و عوامل کلیدی ناسازگاری انسان-گرگ در شهرستان هوراند، آذربایجان شرقی

مرتضی نعمت پور، نادر حبیبزاده*

گروه محیط زیست، واحد تبریز، دانشگاه آزاد اسلامی، تبریز، ایران

(تاریخ دریافت: ۹۸/۰۱/۲۰ تاریخ پذیرش: ۹۸/۰۵/۱۴)

چکیده

هدف پژوهش، بررسی عوامل کلیدی ناسازگاری انسان با حیات وحش با تمرکز بر هشت گونه و شناسایی عوامل کلیدی ناسازگاری انسان-گرگ در روستاهای شهرستان هوراند، آذربایجان شرقی بود. در هر ۳۷ روستایی که به طور تصادفی انتخاب شدند، به کمک دهیار فهرست خانوارهایی که گله دار محض بودند، گله دارانی که کار گله داری را همراه با کشاورزی انجام می دادند و خانوارهایی که تنها شغل کشاورزی داشتند، مشخص شد. از این فهرست، چندین خانوار از هر سه دسته (۱۰ درصد از خانوارهای هر دسته) در هر روستا به طور تصادفی انتخاب شد. بعد از مشخص کردن خانوارهای هدف، تنها با فرد ارشد خانوارها به کمک پرسشنامه نیمه ساختاریافته مصاحبه انجام شد. نتایج نشان داد که سه گونه گوشتخوار (گرگ، خرس و کفتار) به همراه گراز جزء گونه های بسیار مشکل ساز طبقه بندی شدند، ولی مردم دید منفی تری به گونه های کفتار و شغال نسبت به گرگ و خرس داشتند. شدت ناسازگاری مردم با گرگ با تنوع منابع درآمدی مردم و میزان تلفات دامی ناشی از بیماری ها رابطه مثبت، ولی با افزایش شناخت مردم از گونه های حیات وحش رابطه منفی نشان داد. نتایج نشان داد که برنامه های حفاظت از تنوع زیستی در مدیریت ناسازگاری-های مردم منطقه با گرگ، باید توجه بیشتری به مدیریت روستایی هایی که شغل کشاورزی را به همراه دامداری همزمان انجام می دهند، داشته باشد.

* مؤلف مسئول

Bibliographic information of this paper for citing:

Nematpour, M, Habibzadeh, N 2019, The attitude of Horand's villagers toward wildlife and determinants of human-wolf conflict, East Azerbaijan, Iran. Caspian Journal of Environmental Sciences, 17: 259_269

Copyright © 2019