

Persian translation of this paper entitled:

مبانی معماری مقابر امامزادگان در ایران

is also published in this issue of journal.

Architectural Basics of Imams Descendants' Holy Shrines in Iran

Behzad Masoudi Asl^{*1}, Ahmad Ali Farzin², Shohreh Javadi³, Nasser Barati⁴

1. Ph. D. Condidate in Nazar Research center.

2. University of Tehran, Iran.

3. University of Tehran, Iran.

4. Imam Khomeini University, Iran.

Received 2017/12/25

revised 2018/08/20

accepted 2018/08/27

available online 2018/09/23

Abstract

Statement of Problem: According to existing statistics, there are more than four thousand descendants of Shia Imams in Iran as the major hub of Shiism. During Islamic era in Iran, a number of magnificent mausoleums were constructed for these respected descendants of Shia Imams which have given rise to a special style within Iranian architecture after the mosques. It is noteworthy that in many of the mausoleums of descendants of Shia Imams their basic influence on the process of formation, identity and expansion of many of Iranian cities in the Islamic era. Therefore, according to the fundamental and ideological importance of the holy shrines in Iran, it is important to perform explorations and researches in various aspects regarding the origin and the genesis and the formation foundations and development of them so that the architects can be provided with a better recognition thereby to copy their models and patterns. Of course, it is worth mentioning that, besides the Shiite holy shrines, there are many other mausoleums in Iran's Sunni-dwelling regions constructed with the same patterns that belong to the assistants of the prophet (may Allah bestow him and his sacred progeny with the best of His regards), Rashedin caliphs and Sunni Scholars.

Study Objectives: the present study aims at investigating the importance and the position of architectural basics of the honorable holy shrines in Shiite denomination that can open a novel orifice to discussions on Iranian-Islamic architecture and, in fact, the main objective of the study is acquiring the architectural principles and basics of the holy shrines and figuring out and recognizing the quality of their commonalities in conceptual and objective forms and, eventually, using these principles as theoretical foundations in the contemporary memorial holy shrine architecture.

Study Method: the present study has been carried out based on an analytical-descriptive method and utilizes qualitative research style to analyze the content and finally infer and express the general principles. The information has been collected through library research and referring to authentic historical documents as well as via field studies. To do so, the historical background and the theoretical basics of the topic have been seminally investigated. In a second stage, five examples of the prominent architectural styles belonging to various eras have been selected and the geometry and the constituent elements, spatial position, naturalism and decorations therein have been evaluated and analyzed.

Study Results: in the end, the study findings revealed many considerable points regarding the principles and basics of the holy shrines' architecture and they are all indicative of the idea that despite their being built in various eras and making use of different forms and inscriptions and even varying functional roles, these holy shrines feature common and identical principles such as naturalism, symbolism, introversion, similar vernacular masonry, geometry, regular polygons, use of sacred religious symbols and elements like four-dome roofs as well as the collective space functioning.

Keywords: *architectural style of holy shrines of Imams' descendants, death architecture, mausoleums, architectural basics, sacred places.*

✉ *. Corresponding author: bmasodiasl@yahoo.com, +989121402534

Introduction

The architecture of the mausoleums and holy shrines of Imams' descendants is amongst the most diverse and most persistent types of architecture in Iran second in rank following the lead of those of the mosques and they are enumerated amongst the holy places and the construction of these edifices is more evident in Iran in respect to other Islamic countries due to the Shiism attitudes. The study of these works and buildings as well as the formation and variation processes can provide for the analysis and evaluation of their evolutions in the society. The memorial and symbolic role of such a type of architecture in various historical periods is very notable. "The sacred mausoleums, meanwhile being the centers of the Iranian cities' skeleton, are the grounds of the cultural and social events and life of the citizens in certain times and occasions" (Pirniya, 2008). Therefore, the present study analyzes and evaluates the architecture of the holy shrines of Imams' descendants in Iran. That is because these edifices are culturally and socially attractive to the individuals and groups in the society and they enjoy a space featuring religious and spiritual feeling and moods and they are also considered as the sustainable cultural and identity symbols. In textural terms, as well, these holy shrines are situated in the key and structural spots of the cities and/or in the heart of the nature. "Recreation in the depth of the nature and under the shade of trees has been an exemplary perspective for the Iranian poets and it has been interlaced with the tradition of pilgrimage to the fellows of mausoleums and ritual journeys" (Masoudi Asl & Farzin, 2016).

In the meanwhile, connecting and attaching the spaces of the holy shrines inside the urban texture with their components and elements in the periphery, especially the network of the passageways and primary and secondary paths, mosques, markets and peripheral neighborhoods as well as these holy shrines' being positioned outside the cities hence adjacent to the natural elements like water, tree, mountain and so forth are of a considerable

importance. "Javadi" has the following statement in this regard: "in the Islamic era, water and tree are not essentially sacred but it is their important role in the people's lives and their being tied with the old beliefs and emphasized in the Holy Quran that render them noteworthy and favorable" (Javadi, 2013).

It can be discerned via investigation and analysis of the various types of the holy shrines of the Imams' descendants that they are highly diverse and have exerted a large deal of influence on their peripheral environment and urban view. The present article attempts studying and evaluating some selected examples of the holy shrines that have been more successful in functional, identification and aesthetical aspects so that their governing principles and regulations can be figured out.

The Primary Study Question

1. What are the principles and basics governing the architecture of the holy shrines of the Imams' descendants?

Statement of the Problem and Study Background

The primary objective of the present study is the theoretical investigation of the architectural basics of the holy shrines of the Imams' descendants and, finally, finding the existing principles and solutions based on the theoretical and reliable supports and foundations so that appropriate process and method of treating the subject of Iran's memorial holy shrine architecture can be codified. Unfortunately, despite the prominent examples of such a type of architecture in Iran and its political and religious importance, there are not carried out many comprehensive researches bearing the abovementioned subject. However, some related research conducted in the past two decades regarding Iran's holy shrine architecture can be pointed out. The results obtained from these studies have been summarized in the following table (Table 1)

Theoretical Foundations of Holy Shrines' Architecture

Amongst all the religious edifices, mausoleums and, especially, the holy shrines along with mosques are considered as the most important Iranian edifices. It can be highlighted in a study of the history of mausoleums in Iran that the ancient mausoleums have been formed and perfected in a natural and organic manner as pilgrimage-recreational spaces (Hoseyny, 2010). After Sassanid era and with the advent of the evident religion of Islam, the structures of the holy shrines and mausoleums were heavily questioned in such a manner that the great Apostle of Islam (may Allah bestow him and his sacred progeny the best of His regards) ordered that it has to be favored by the believers not to construct any building on the mausoleums and the mausoleums should be built completely in the same level with the ground. At that time, Muslims should avoid any mourning and crying and grieving on the mausoleums of the dead as ordered by His Highness Muhammad (may Allah bestow him and his sacred progeny the best of His regards) and this was continued to the extent that the dead's graves were built on the ground level and no traces of them could be found in the course of time (Gheravi, 1999). This way, no special trace of mausoleum can be found in the very beginning of Islam. But, the construction of shades over the mausoleums of the commanders killed in the border battles was allowed during these same years for the reasoning that the land above their mausoleums should be kept safe against the abuse of the wind and rain and, after a short while, the mausoleums of the great assistants of the prophet, as well, were covered with wooden indices and tents that became known as pergola mausoleums. However, in the early Islam era, the prevalence of the fundamental Islamic beliefs prevented the mausoleums from being essentially developed. In Samanid era, the mausoleum of Esmā'eil Samani, Ghabous Vault and Ali Abarghou Vault were built and it seems that each have been somewhat inspired by the pre-Islam architecture. Seleucid Sunnis

diversified the form of the mausoleums and created a structure named tower mausoleum emphasizing on elevated construction of the mausoleums (Daneshvary, 2011).

There are mentioned definite AYAT in the Holy Quran for the burial of the dead and burying in SOil is one of the important principles of the religion and shrouding in cerement and ablution, except for the martyrs, and laying the corpse with the face towards Ka'aba are necessary and unquestioned. On the other hand, protruded mausoleums and construction of buildings over them is not only not recommended but also denied in many of the religions. However, one of the important attributes of Islam is its possibility of adaptation with the cultures existing in the newly-converted territories. Iranians, as well, preserved an important part of their myths regarding death and burial rites and construction of mausoleums upon accepting Islam. Gravestone considered in the ancient myths as ensuring the never returning of the dead was turned into a symbolic element for indicating the personality of the dead person as well as a place of expressing the religious art creativities. To investigate the mausoleum-making art in pre-Islam era, it has to be noted that about 800 years before Islam and some 200 years after the advent of Islam, mausoleum-making has not been worthy of note in Iran. So, considering the outset of mausoleum-making in the third hegira century and construction of valuable works like the mausoleum of Amir Esmā'eil Samani and Ghabous Vault, the question is raised as to how has such an architecture come about while it has not been around in serious form for nearly a thousand years?

Three different routes have been taken in finding an answer to the above-cited question:

Connection with Achaemenes Mausoleum-Making, Especially Cyrus Mausoleum

Cyrus mausoleum as an independent and elevated volume with a room for burial and presence of individuals for performing rituals is a concept that

Table 1. The study background regarding funerary architecture. Source: authors.

Article title and date	Author	Proposed topics
Pirmorad Mausoleum, the ritual cultural perspective of Baneh County (2011)	Farnoush Mokhles, Ahmad Ali Farzin, Shohreh Javadi	Expression of the cultural basics and concepts crystalized in the natural cultural view of Baneh's Pirmorad Mausoleum
Investigation of the formation trend of funerary architecture in Islamic Era Iran (2009)	Sayyed Hashem Hosseini	Direct relationship of the mausoleum architectural design with the Sufism streams in Iran
Factors influencing the formation trend of Iran's funerary edifices in the mid-Islam Era (2012)	Sahel Ghasemi	The political and economic power of the country was the most important factor in the formation of the mausoleums and Zoroastrian and Turk tribes' traditions have been effective on the architecture and form
Islamic arts in the architecture of the holy shrines (2011)	Esmā'il Ma'arufi Aghdam, Ali Asghar Mahmoudi Nasab	Tiling is the most important and most frequently applied art and the peak of the architectural decorations in the holy shrines
Reflecting the role of holy shrines in the identity of the urban view (2011)	Ahmad Ali Farzin	Holy shrines as the most valuable places and indicators constructing the people's perception of the city and forming the urban view
Blending art and religion in the architecture of the holy shrines (2014)	Sayyed Ali Asghar Tabataba'einiya	The existence of various kinds of art (calligraphy, inscriptions, ornamented vaulting, stucco relief and so forth) in the holy shrines' environments, very effective on the spectators' emotional foundation and system
Investigating the role of Shiism in art and architecture of Iran's holy shrines (2016)	Mozaffar Abbaszadeh, Ilghar Ardabilchi, Raihaneh Ya'aghoubi, Saba Makhlooghi	All of the arts used in this type of holy shrines deals with the expression of Shiite concepts.
Mazandaran's holy places (2009)	Shohreh Javadi	Many of the past religious places have been kept after Islam but their contents and occasionally forms of worshipping are changed so that they might be coordinated with the new religion.
Holy places in connection with nature (water, tree and mountain) (2007)	Shohreh Javadi	The positioning of the holy shrines in the vicinity of water, spring and mountain is a souvenir from the ancient beliefs indicating naturalism

is identifiable in serious manner in the architecture of the post-Islam mausoleums, especially towered mausoleums. Ghabous Vault does not differ so much from Cyrus mausoleum in terms of its constructional elements and it is situated on a height, it has a room for burial and features a sloped

roof and, of course, visible from distance.

Connection with Four-Dome Pattern

An example of the single-mausoleum pattern or memorial edifice of Cyrus is located in Pasargad and Ghabous Vault can be pointed out as an

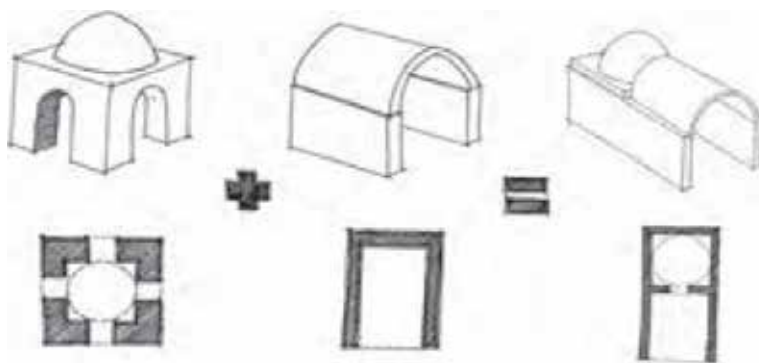

Fig. 1. A schematic view of the stages of four-dome mosque formation. Source: Soltanzadeh, 1983.

Islamic example of memorial mausoleum. As put by Goddard, the four-dome edifice, “is the only building reflecting and representing the ancient Iran’s religious architecture” and “the real example of national edifices inspired from Zoroastrian rites and always a symbol of the creed of Ahoura Mazda followers” (Goddard, 1992).

From the past up to now, four-dome edifices are attributed to Sassanid Era’s fire-temples. But, the four-dome pattern dates back to Zoroastrian rites and the time of Mithra and Anahita worships and they have been transformed into fire-temples upon the emergence of the new religion (Javadi, 2017) Single and intact four-dome patterns are dispersed in various spots in Iran and many of them have been currently given religious names. Undoubtedly, these have been sacred places and the Islamic names have guaranteed the persistence of their sacrosanctity (Mansouri & Javadi, 2016).

Four-Dome architecture as the cornerstone of the Iranian architecture’s spatial patterns has definitely played an influential role in post-Islam Iranian mausoleum-making. It has to be specially noted that the pattern whose connection with ziggurat is debatable has been the most important religious architecture style in the entire period of Sassanid Era and it is found having lost its position in the architecture for a while after the Islam’s entry of the region. So, it finds it auspicious to reappear in one of the architectural types closest to its style that

is mausoleum-making and Amir Esma’eil Samani’s mausoleum with its square plan and a vault on the intersection between the building’s axes is definitely the reemergence ground of four-dome pattern in Iranian architecture. The first specimen of four-dome pattern application after the Islam’s entry of Iran can be found in four-dome mosques because the Muslims performed their worshipping rituals mostly in the fire-temples during the early Islamic era (Soltanzadeh, 1983).

On the one hand, this splendid architectural structure possesses general attributes that can be seen with few changes in the entire remaining examples and, on the other hand, signs of difference are evident in them according to the geographical conditions of the region and the time during which the edifice has been built. But, the point that is noted by everyone is the common feature, i.e. the four-dome pattern, of all Iran’s religious buildings before and after the advent of Islam (Shayesteh, 2008).

Connection with Exotic Architecture

Considering the long prohibition of mausoleum-making in Iran, mausoleum-making patterns have been transferred to Iran from other countries with the following two theories:

Donald Wilber, a researcher in Iran’s architecture, believes that mausoleum-making pattern has been transferred to Iran from Syria as a colony of Roman Empire. Of course, the existence of temples like

Pantheon and their similarities to Iran's towered mausoleums is seriously suggestive of such a probability but it has not been proved based on exact documents.

Being influenced by the traditions of the people from northern and eastern parts of Central Asia whose mausoleums were built using highly persistent constructional materials in the form of large yurts and the corpse was exposed to everyone's sight in a funeral tent and the mourning groups came around the corpse; in the meantime, they used to bury their dead in a hill named Gourkan (Sobuti, 1991).

The Historical Evolution Trend of the Holy shrines of Imams' Descendants in Iran

Extensive activity in the construction of mausoleums on the authentic martyrdom places and graves of the Imams' descendants was started since the period of Al-e-Bouyeh government (912-1026), especially at kingship era of Azd Al-Dawleh Fana Khosrow (Rice, 2001). In Seleucids' Era, the promotion of Shiite denomination and construction of the mausoleums for the Shiite elders considerably grows even with the existence of a Sunni government and this is reflective of Shiites' authority in certain regions of Iran.

With the Mongols' invasion of Iran and their being impartial in supporting the Islamic religions, the road becomes paved for the Shiites to prove their presence (Ja'afariyan, 2010). With the overtaking of the power by Shiite school in Ilkhanate era in this country, the Iranian architecture and, subsequently, the mausoleum-making for the Imams' descendants, enters a new epoch of history. In continuation of this trend, the expansion in Shiite denomination provided for the Shiite architects and artists' reflection of their own beliefs and opinions in certain styles of architecture such as mosques and holy shrines (Gheravi, 1999).

Despite the onset of mausoleum-making in Samanid and Qaznavi eras, Ilkhanate and Timurid eras can be realized as the peak of holy shrine construction in Iran wherein the transformation of separate holy

shrines to a collection of buildings like mosques and schools with the holy shrine being positioned in the center can be witnessed. With the overtaking of power by Safavid in Iran, although the construction of the mosques, schools, palaces, caravansaries and other buildings of the like was kept on like before, the formalization of the Shiite denomination made the art and architecture become the language of expressing Islamic concepts and teachings and, particularly, Shiite denomination. It is evident that these teachings had a greater opportunity of being expressed in the religious edifices such as mosques and religious mausoleums and so forth. In Safavid era and after that in Qajar era, as well, special attention was paid to the construction of majestic mausoleums, repair and decoration of them for the offspring of the immaculate Imams, scholars and saints.

An Analysis of the Formative Style of Holy Shrines' Architecture

Although numerous classifications have been made in relation to the formative structure and architectural style of the holy shrines' edifices, they can be divided in an approach based on a consensus reached by the majority of the researchers into towered mausoleums and domelike or square vaulted mausoleums (Hillenbrand, 1998: 342-343).

In the early Islamic era, the construction of the vaulted square mausoleums was revealed as an ancient method of Islamic mausoleum-making and Esma'eil Samani mausoleum in Bokhara can pointed out as one of the most ancient specimens remaining from such a funerary style (Ettinghausen and Grabar, 1999: 301). However, during the late forth hegira century, the towered mausoleums were preferred to vaulted square mausoleums and it became one of the main forms of mausoleum-making within the interval from the fifth to eighth hegira century but, unlike the towered mausoleums that became prevalent since the ninth hegira century, the vaulted square mausoleums were prevalently constructed almost in all the Islamic periods

(Hillenbrand, 1998: 342-366). A novel change comes about in the vaulted mausoleums during Ilkhanate period in such a way that the edifices are more enlarged and constructed more magnificently. The best example of such a type of buildings is Soltaniyeh Dome in Zanjan (Bererton, 1998: 95). In Timurid era, the squared mausoleums are constructed mostly in small scales and there is made emphasis only on one aspect of the building like pre-vault or the vault's neck or both (Hillenbrand, 1998: 359). From Safavid Era on, no sign of

towered mausoleums can be found and the vaulted square mausoleums became the only form of choice in the architectural styles of the mausoleums from this period because the architecture was a function of geography and environment until before Safavid Era and various kinds of domes and minarets are observed in various spots in Iran; but, in Safavid's tenure of the government, the architectural styles commonly applied in the capital cities were also considered in construction of mausoleums in the other regions (Table 2)

Table 2. general classification of holy shrines' architecture in Iran in an order of the government eras. Source: authors.

Government period	Prominent examples	Explanations
Samanid and Saffavid	-	Vaulted square mausoleums rooted in four-dome and fire-temple styles
Qaznavi and Seleucid	The mausoleum of Yazd's twelve Imam, Damghan's Emamzadeh Ja'afar	Construction of towered mausoleums, regular polygonal plans, addition of cellars, use of pre-dome, brick decorations
Ilkhanate	Emamzadeh Khadijeh Khatoun in Maibod	Use of towered high-rise mausoleums and highly deeparches in the exterior view of the holy shrines, prevalence of gathering hall, mosque, school, mausoleum, plaster and colorful decorations
Timurid	Japalagh's Emamzadeh Ghasem and Ardabil's Sheikh Safi Al-Din hall	Emphasis on the magnificence and elevation, construction of schools and mosques at the side of the holy shrines, increase in the decorations and tilework inscribed with animal shapes and regular inscriptions bearing Nasta'aliq calligraphy, use of arches over the façade and working on the exterior view
Safavid	Ghazvin's Emamzadeh Hussein mausoleum, completion of Imam Reza (PBUH) and Her Highness Ma'asumeh (PBUH) holy shrines, Neishabur's Ghadamgah	Construction of luxurious vaulted mausoleums for the Imams' descendants, holy shrines and mausoleums as the nucleus or gravity center of the cities and the placement of other city organs alongside with them, completion of the hierarchy of reaching the sepulcher
Afsharid	Robot Karim's Emamzadeh Ghasem Vahidiyyeh	Construction of the holy shrines with inspiration by Safavid era mausoleums and continuation of their styles
Zandiyeh	Shiraz's Emamzadeh Bibi Khadijeh	Reduction in the construction of holy shrines, addition of gold-coated minarets to the holy shrine of Imam Reza (PBUH)
Qajariyeh	Shiraz's Emamzadeh Abutaleb	Repair and decoration, addition of single and threefold porches to the square-shaped holy shrines from Safavid Era, mirror surfacing in Imam Reza (PBUH)'s holy shrine, gold-coating of Her Highness Ma'asumeh (PBUH) dome

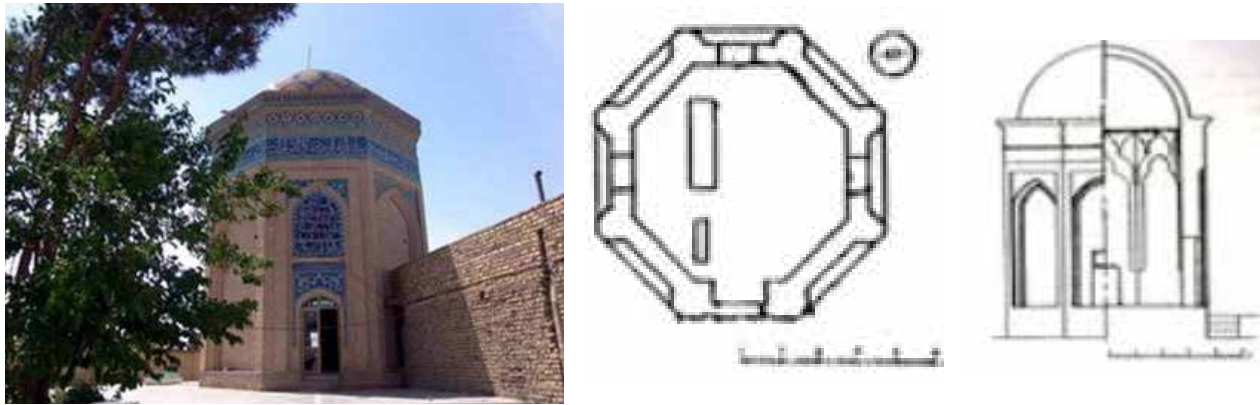

Fig. 2. Plan, cross-section and exterior view of Isfahan's Emamzadeh Ja'afar. Source: www.arthut.com.

Table 3. architectural design of Isfahan's holy shrine of Emamzadeh Ja'afar. Source: www.arthut.com.

Building's name	Construction date	Geometry	Construction place	Constituent elements	Naturalism	Decorations
Isfahan's Emamzadeh Ja'afar	Eighth hegira century (۱۳۰۴-۱۳۰۷)	Octagonal, facing towards Ka'aba, introversive, symmetrical	Constructed on the midway of the access route to old city of Isfahan in the vicinity of gardens in the heart of the nature	Four-dome, use of regular polygons and even numbers' manifestation, entrance, mausoleum and dome	Use of Chinese Girih with plantlike inscriptions, use of vernacular masonry and natural colors like azure blue, cyan, white, khaki	Use of inscriptions, blending inscriptions and Chinese Girih, use of Kuffi calligraphy like Thulth, tilework, interior brick and plaster coating

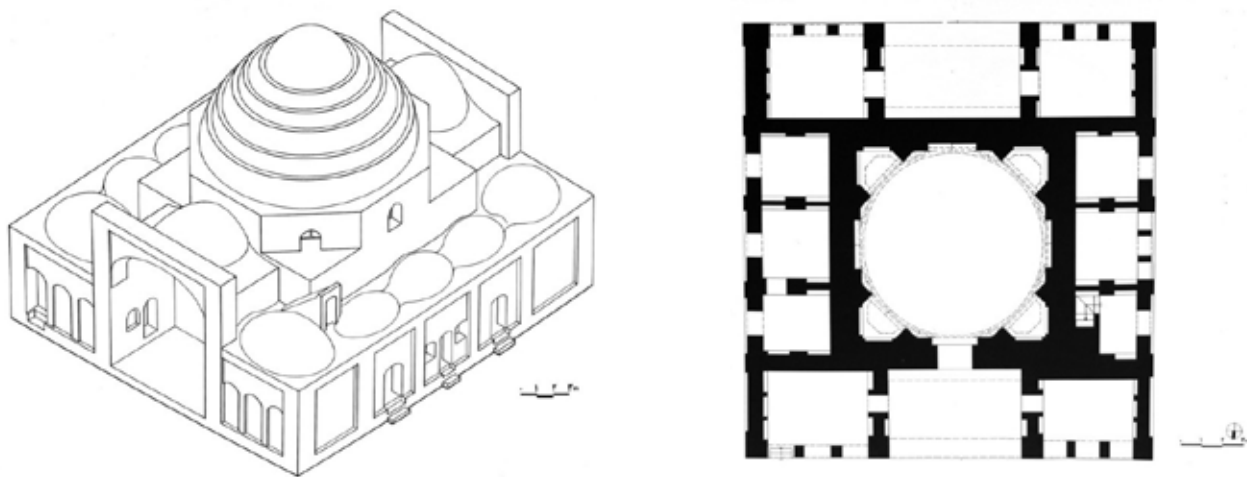

Fig. 3-1. plan, perspective, cross-section and exterior view of holy shrine of Varamin's Emamzadeh Yahya. Source: www.arthut.com.

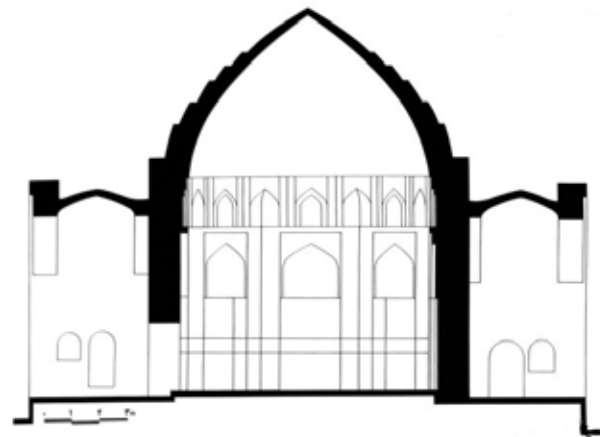

Fig. 3-2. plan, perspective, cross-section and exterior view of holy shrine of Varamin's Emamzadeh Yahya. Source: www.arthut.com.

Table 4. architectural design of holy shrine of Varamin's Emamzadeh Yahya. Source: authors.

Building's name	Construction date	Geometry	Construction place	Constituent elements	Naturalism	Decorations
Varamin's Emamzadeh Yahya	Eighth hegira century (1286)	Square precinct, octagonal internal area, introversive, faced towards Ka'aba, symmetrical	Constructed in an old neighborhood called "Kohneh Gol" in the middle of a garden	Four-dome, use of regular polygons, porch, mausoleum, entrance, yard, dome	Use of Chinese Girih with plantlike inscriptions, vernacular masonry, golden, cyan, azure, green and brown colors, in the vicinity of water and trees	Inscriptions, Chinese girih, blending inscription with Chinese girih, use of Kufi calligraphy like Thulth, star-like tilework, brick inscriptions interior brick and plaster coating

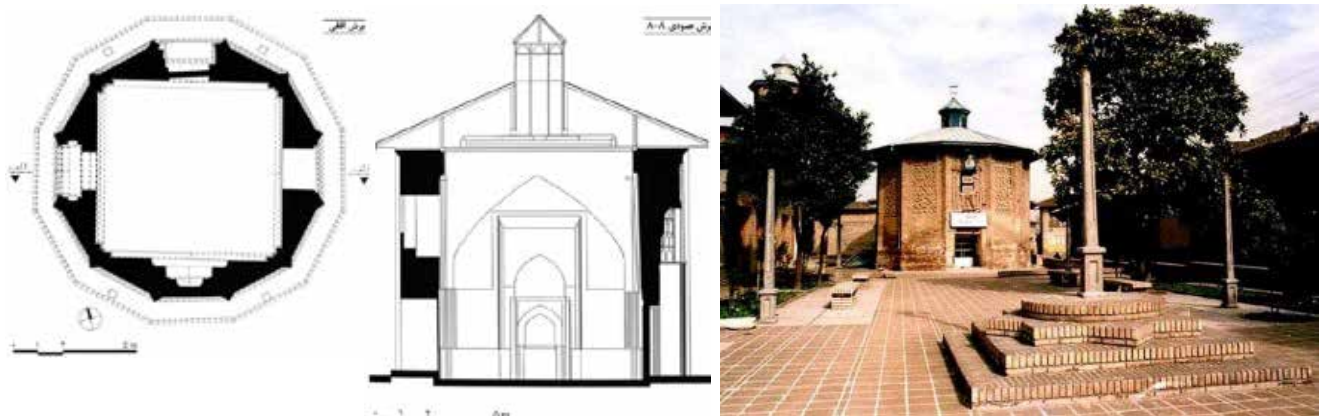

Fig. 4. Plan, perspective, cross-section and exterior view of holy shrine of Gorgan's Emamzadeh Eshagh (Noor). Source: www.arthut.com.

Table 5. architectural design of holy shrine of Gorgan’s Emamzadeh Eshagh (Noor). Source: authors.

Building’s name	Construction date	Geometry	Construction place	Constituent elements	Naturalism	Decorations
Gorgan’s Emamzadeh Eshagh (Noor)	Ninth hegira century (1414)	Twelve-sided polygonal precinct, square internal area, introversive, faced towards Ka’aba, symmetrical	Constructed in old Gorgan’s Sarcheshmeh neighborhood in the middle of an old garden cemetery	Four-dome, use of regular polygons, manifestation of even numbers, entrance,	Use of carvings and inscriptions bearing the shapes of flowers and leaves and paisley design in wooden elements, use of natural colors like brown, white and khaki	Plasterwork, brickwork, use of kuffi calligraphy, brick vaults, interior brick, plaster and stone coating

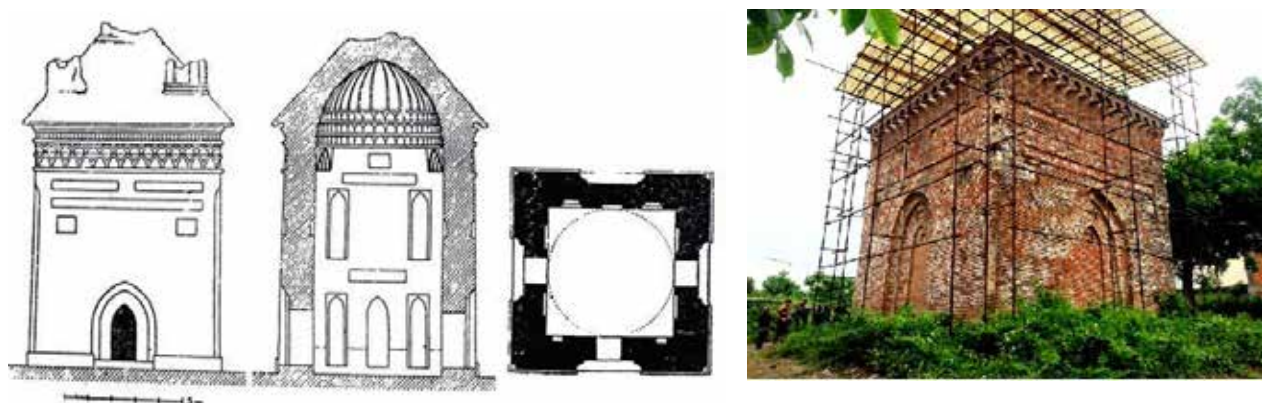

Fig. 5. Plan, perspective, cross-section and exterior view of holy shrine of Amol’s Shams Al-e-Rasoul Mausoleum. Source: www.arthut.com.

Table 6. Architectural design of holy shrine of Amol’s Shams Al-e-Rasoul Mausoleum. Source: authors.

Building’s name	Construction date	Geometry	Construction place	Constituent elements	Naturalism	Decorations
Amol’s Shams Al-e-Rasoul Mausoleum	Eighth hegira century, the main foundation of the building belongs to pre-Islam era	Square plan, introversive, faced towards Ka’aba, symmetrical	In the middle of a plain in the periphery of old Amol inside the gardens	Four-dome, use of regular polygons, cone-shaped vaults, entrance, sepulcher	Use of natural colors like brown, green, khaki, situated near water and trees	Brick rows in the spoon, crescent and blade forms, ornamented vaulting, tilework, pyramid corner-working, inscriptions, use of brick in various sizes, brick and plaster interior coating

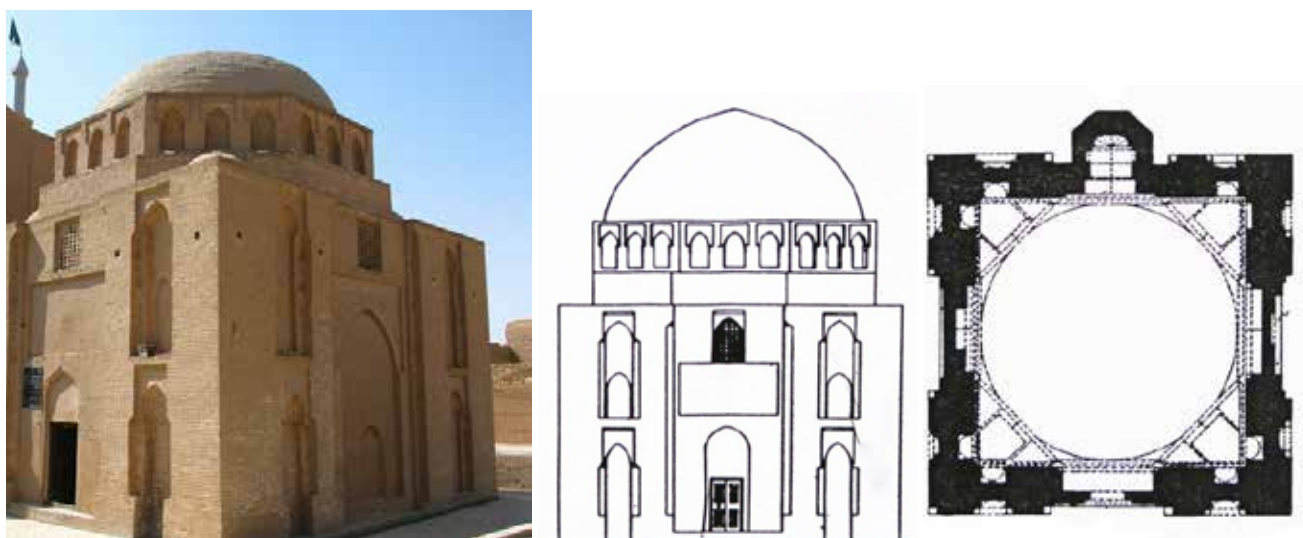

Fig. 6. Plan and exterior views of holy shrine of Yazd's Davazdah Emam Mausoleum. Source: authors.

Table 7. Architectural design of holy shrine of Yazd's Davazdah Emam Mausoleum. Source: authors.

Building's name	Construction date	Geometry	Construction place	Constituent elements	Naturalism	Decorations
Yazd's Davazdah Emam Mausoleum	Fifth hegira century, in a fire-temple's land	Square plan, introversive, faced towards Ka'aba, symmetrical	In the middle of a garden cemetery in Yazd's Fahadan neighborhood in the vicinity of Hosseiniyeh and mosque	Four-dome, use of regular tetragons, cone-shaped ornamented vaulting, entrance	Use of natural colors like brown, khaki, situated inside a garden	Brickwork and brick inscriptions, ornamented vaulting, corner-working, tilework, mosaic, Kuffi calligraphy, interior plaster and brick coatings

Evaluation of the Case Examples Based on the Scales Extracted from Holy Shrines' Architectural Analysis

This section studies several examples of the holy shrines based on a library method and exploration of the authentic historical documents. In spite of the fact that the different textural, content-related, historical, functional, economic, taste-related, vernacular and other aspects and dimensions renders it difficult to analyze the architecture of the holy shrines, the authors have directed their attentions to the five primary indicators, named geometry, constituent element, construction locus, naturalism and symbolism, of the holy shrines' architecture

based on the performed studies and interviews with the corresponding specialists. In the meanwhile, principles of the holy shrines' architecture exercised in the early centuries of mausoleum-making in Iran have been taken into account in the selection of the case examples and efforts have also been made to firstly select the mausoleums that are architecturally worthy of consideration and secondly have undergone the least change in their form generalities; in the meantime, care was exercised to select them from various climatic regions and different periods of funerary architecture. Therefore, the examples are first of all investigated in separate and then the obtained results will be categorized.

Summary of the Studied Cases

- In the studied cases, the paying of attention to the creation of polygonal edifices with even numbers, four, eight and twelve, is observed and this has not been haphazard for sure. Possibly, the evenness of the diagonals has provided with the technical facilities of the construction.

- Introversion and symmetry of all the constructional elements and giving the original priority to the mausoleum is the common aspect of all the aforesaid buildings.

- The use of brick as the main constructional material in these examples in various forms and based on various methods of implementation, besides playing an applied and ornamental role, has been carried out due to climatic and vernacular considerations; and, the high-rise dome over the sacred mausoleums is a symbol of centralism and a sign of the importance and memorial nature of the building.

- According to the idea that consecration is the most important indicator of constructing the holy shrines in the public mind, besides the existence of four-dome pattern as a religious and archaeological sacred symbol and familiar social elements like vault and so on in their architecture, natural elements like mountain, water and tree that are believed to be sacred by the general public are also found in the vicinity of these buildings.

- In an investigation of the location of the aforementioned holy shrines, it can be observed that they are constructed besides the roads, gardens and/or sacred natural elements like trees and water and/or on top of the mountains and hills or on the plain slopes. Although water and tree are not essentially sanctified in the Islamic period, they have been the focus of attention and favored due to their important roles in the people's lives as well as their connections with the old beliefs and the emphasis made in the holy Quran on them.

- The calligraphies used in the mausoleums of these holy shrines, besides serving ornamental functions and eternalizing the common arts for their making use of the holy Quran's AYAT, prayers and poems,

have granted spiritual and holy and otherworldly aspects to these places.

- The geometry and basic shape of the architecture in these buildings are based on four-dome patterns and this has caused a full-scale expansion in the space through adding Islamic architecture elements thereto in some of the exemplified buildings based on their functions as well as economic, social and political situations and conditions.

-The ornamentations and decorations used in these buildings are mostly tilework, brickwork and inscription writings all of which are predominantly taken into consideration when constructing holy places. These decorations are mostly evident on the exterior views; brick and plaster coatings are largely seen in the interior spaces. Also, the selection of the plantlike inscriptions is not irrelevant to the culture and history of the ancient times, for example the existence of pomegranate or lotus in the ornamentations is rooted in the consecration of these plants in Iranian mindset.

Final Conclusion

According to the sanctity of the holy shrines and the culture of pilgrimage to the mausoleums of the Imams' descendants in Iran, the architectural design of the holy shrines features two aspects: external (symbolic and advertising) and internal (people-oriented and simple). In regard of defining the external aspect of the building, efforts have been made to keep the magnificence and grandeur and persistence of the building based on climatic conditions and the facilities existing in every period to the highest possible degree in contrast to the other edifices. The façade decorations (that have, of course, changed linearly with the progresses in the constructional materials' use) are integral parts of the symbolic principles and naturalism norms in line with the corroboration of the external aspect of the building and adding to the importance thereof. These decorations mostly serve practical and aesthetical functions. Parallel to the strengthening of the internal aspect, the approach adopted is

prioritization of the introvert internal spaces in human scale and the use of simple brick and plaster ornamentations to create a sense of privacy and spirituality. In the meanwhile, considering the Quranic descriptions regarding the images of paradise and also blending of the recreation culture with pilgrimage culture in Iranians, the architectural design of the holy shrines and their precincts are based on the Iranian garden patterns as far as it can be afforded. Therefore, the more the facilities they have had available then the more they have been turned into a garden-like and recreational space.

In the meanwhile, the holy shrines can be divided into two types of inside the urban texture and outside the urban texture and spaces in a summing and general classification of the architecture of the holy shrines. These two classes, despite having abundant common principles and basics, feature separate characteristics as recounted below:

Holy Shrine Architectural Design Outside the Urban Texture and Spaces: this type of architectural designs, like the other holy buildings in ancient Iran, are in direct connection with the nature considering the ancestors' traditions and the adjacency of the building to the natural elements like water, tree, mountain and plain is completely vivid. Such naturalism can also be observed in the colors, masonries and inscriptions used in the holy shrines. The entire building features a symbolic and memorial aspect in this type of architectural designing of the holy shrines.

Holy Shrine Architectural Design Inside the Urban Texture and Spaces: the mausoleums of the Imams' descendants that are connected to the urban space and cities are served as the cultural perspective and a collective space in connection to the other spaces and roads. In these mausoleums, the yard plays a more accentuated role than the building itself in such a manner that the buildings of the holy shrines are mostly used for pilgrimage and personal worshipping and prayers and the yard is considered as the main space that is somehow a collective place for social interaction. In these

buildings, elements like domes and vaults feature symbolic and memorial aspects of the holy shrines.

Reference list

- Bererton, J. P. (1998). Faza- ye moghadas [Sacred space]. Translated by Mohammadi, M. *Journal of culture*, (1): 128-145.
- Daneshvary, A. (2011). *Medieval tomb towers of Iran : an iconographical study*. Translated by Neystani, J. Tehran: Samt.
- Ettinghausen, R. & Grabar, A. (1999). *The art and architecture of Islam 650-1250*. Translated by Ajand Y. Tehran: Samt.
- Gheravi, M. (1999). *Aramgah dar gostsre- ye Farhang- e Irani* [Mausoleums in the territory of Iranian culture]. Tehran: The association of famous cultural works and figures
- Godard, A. (1992). *Athar - E Iran*. Translated by Sarvghad Moghaddam, A. Mashhad: Astan-e-Ghods-e-Razavi.
- Hillenbrand, R. (1998). *Islamic art and architecture*. Translated by E'tesam, I. Tehran: Urban processing and planning company.
- Hoseyny, S. H. (2010). Introducing the style of Azerbaijani theosophists tomb construction. *Journal of fine arts, architecture and urban design*, (43): 57-68.
- Ja'afariyan, R. (2010). The shiite atlas. 3rd ed. Mashhad: Astan- e Ghods- e Razavi
- Javadi, Sh. (2013). Reviewing the Historical Narrative of "Water and Tree" in the Islamic Era of Iran. *Jaco*, 1(1): 43-50.
- Javadi, Sh. (2017). *Report of the novel notions workshop under the title of sacred places in Iran*. Nazar research center's archive.
- Mansouri, S. A. & Javadi, Sh. (2016). *Segane- ye manzar- e Irani* [The thrilogy of Iranian Lanscape]. 1st ed. Tehran: Nazar research center.
- Masoudi Asl, B. & Farzin, A. A. (2016). Public Preferences in Design of Martyrs' Memorials; Reviewing Social Success of Projects by Bonyad-e-Shahid Organization. *Manzar*, (34): 118-125.
- Nasr, S. H. (2012). *Islamic art & spirituality*. Translated by Ghasemiyani, R. Tehran: Hekmat.
- Pirniya, M. K. (2008). *Sabk shenasi- ye memari Irani* [Stylistics of Iranian Architecture]. Tehran: Sorush- e Danesh press.
- Rice, D. T. (2001). *Islamic art*. Translated by Bahar, M. M. Tehran: Cultural and Scientific Press.
- Shayesteh, M. (2008). *Gozaresh- e sabti- ye baghaya- ye memari-e atashkadeh* [A report of the registered architectural relics of fire-temples]. Birjand: Khorasan- e Jonoob Province's Organization of cultural heritage, artefacts and tourism.
- Sobuti, H. (1991). Resurch on soltaniyeh monuments. 1st ed.

Zanjan: Setare- ye Zanjan

- Soltanzadeh, H. (1983). *Ravand- e sheklgiri- ye shahr va*

marakeze mazhabi dar Iran [The process of city and religious centers' formation in Iran]. 1st ed.. Tehran: Agah.

COPYRIGHTS

Copyright for this article is retained by the author(s), with publication rights granted to the Bagh-e Nazar Journal. This is an open-access article distributed under the terms and conditions of the Creative Commons Attribution License (<https://creativecommons.org/licenses/by/4.0/>).



HOW TO CITE THIS ARTICLE

Masoudi Asl, B., Farzin, A. A., Javadi, Sh. & Barati, N. (2018). *Architectural Basics of Imams Descendants' Holy Shrines in Iran*. *Bagh- e Nazar*, 15 (64):5-18.

DOI: 10.22034/bagh.2018.69476

URL: http://www.bagh-sj.com/article_69476_en.html

