

Development of a compression system dynamic simulation code for testing and designing of anti-surge control system

Author

Abbas Mohajer^a
 Saadat Zirak^{b*}
 Eshagh Abbasi^a

^a MAPNA Turbine Engineering & Manufacturing Company (TUGA), Tehran, Iran

^b Mechanical Engineering Department, Semnan University, Semnan, Iran

ABSTRACT

In recent years, several research activities have been conducted to develop knowledge in analysis, design and optimization of compressor anti-surge control system. Since the anti-surge control testing on a full-scale compressor is limited to possible consequences of failure, and also the experimental facility can be expensive to set up control strategies and logic, design process often involves analyses using compression system dynamic simulation. This research focuses on developing and validating a physics-based, modular, non-linear and one-dimensional dynamic model of a compression system: centrifugal compressor and its surrounding process equipment like the scrubber, cooler, recycle line with control and check valves. The mathematical approach of the model is based on laws of conservation and the included ordinary differential equations (ODEs) which describe the system dynamics. It is solved by using a computational method in an in-house FORTRAN code. Compressor characteristics maps generated from company compressor test bench are used to determine compressor pressure ratio and efficiency. All equipment and inlet/outlet accessories as well as test instructions, follow the requirements of ASME PTC10. The simulation within a wide range of operating conditions allows a parametric study to be performed and the optimal values of the control parameters to be selected. In order to check the validity of the model, the simulation results are then compared with experimental data of company industrial compressor test facility and also with operational field measurements.

Article history:

Received : 13 June 2018

Accepted : 16 February 2019

Keywords: Compression, Simulation, Dynamic, Anti-Surge, Control.

1. Introduction

As the cost of damages to the compression systems, in oil and gas industry, can lead to significant capital cost and plants downtime, one must carefully achieve a high level of production and operational reliability for these systems. In recent years, several research

activities have been conducted to develop simulators to predict the compression system dynamic. Such simulator enables the designer to test the new control logic and getting the results before implementing it on the governor system. Using simulators would increase the reliability and prevents undesirable costs resulting from practical trial and error process. Typical control scenarios which have to be considered are process control, starting and stopping, and

* Corresponding author: Saadat Zirak
 Mechanical Engineering Department, Semnan University,
 Semnan, Iran
 Email: s_zirak@semnan.ac.ir

emergency shutdowns. Having such simulator is also supposed to be essential to serve other applications during all stages of the system life cycle, including but not limited to educational tool for operators training, Site Acceptance Test (SAT), Factory Acceptance Test (FAT), and compression plant design optimization.

Anti-surge regulators are employed in multi-processor control systems to keep the compressor operation away from the region where surge instability occurs. Surge is defined as an unstable operation condition of centrifugal compressors, which can occur at low mass flow. It is usually shown by a dashed line on the compressor map, and the pressure pulsation is observed for the operation points to the left of that. This phenomenon often damages the compressor due to excessive stress and vibration caused by mass flow and large pressure amplitude oscillations. Recently, anti-surge control design process often involves useful dynamic simulation of the compression system to provide a more accurate and consistent solution. The possibilities of practically testing anti-surge control strategies and logic on a full-scale compressor are limited because of the consequences of such failures and also, the experimental facility can be expensive to set up. Nevertheless, the reliability of the control system must be examined before the factory and site acceptance test begins. To realize that, it is necessary to simulate the plant's real conditions by simulation tools to verify the system design and to test the control logic for the entire compressor operating range and getting the results before implementing it on the control system. This will increase the reliability and prevent undesirable costs resulting from practical trial and error processes. Therefore, a high fidelity compression system dynamic simulation environment was developed by MAPNA (TUGA) to design an anti-surge control system with enhanced control capabilities. Having such a simulator is supposed to be essential to serve other applications during all stages of the product life cycle, including but not limited to the followings:

- As a valuable educational tool, it can help compressor experts to have a better understanding of the logic and use it for fault diagnosis purposes,
- It could be used to train the operators in an interactive virtual environment that closely approximates the real conditions and can serve to improve the required skills to make the best decisions responsively enough at the times of need,
- Enables simulating the hazardous operating conditions, even those which might take place rarely during the compressor life cycle and give an idea of what response would be better in those conditions.

During the years, several models have been presented in the literature to predict the dynamic behavior of the compression systems which can be classified on the basis of flow assumptions, inclusions of rotational speed, compressor type and the covered instability [1]. A useful overview of available modeling techniques developed by different researchers is presented in [2]. The most widely used model to describe the dynamic behavior of a compressor is the Greitzer model [3]. The compression system in Greitzer model involves a compressor, a plenum volume, ducts and throttle. It was demonstrated by Hansen et al. that the Greitzer model is also applicable to centrifugal compressors [4]. Fink et al. extended the Greitzer model to incorporate compressor rotational speed as a system state [5]. Based on the work of Fink et al, a similar model was derived by Gravidahl and Egeland, which uses compressor characteristic from energy transfer and loss analysis [6]. More recent works based on Greitzer model are presented in [7, 8 & 9] which use the model to control system design.

Since the Greitzer model is relatively simple, low order and requires few parameters, it is usually used by researchers investigating dynamic behavior of compression system in different applications. Although, Helvoirt and Jager stated that the Greitzer model alone is not adequate on the dynamic modeling of a much more complex

system like large industrial compression system in the process plants and pipeline compressor saturations [10]. The systematic model presented by Botros et al. was one of the most comprehensive works that aimed at analyzing such complex compression system components dynamic interactions, particularly during ESD¹ [11, 12]. In this approach, the Greitzer and Moore model [13] has been extended to centrifugal compressors. The simulation solver of the fluid governing one-dimensional full partial differential equations is based on the method of characteristics [14, 15].

Furthermore, development of a modular model for the dynamic simulation of compression system was also pursued by Morini et al. [16, 17& 18]. In their works, a model for the simulation of the dynamic behavior of compression systems is developed. Mass, momentum, and energy balance equations together with the spool momentum balance are written through a general approach. The model is implemented in Matlab Simulink tool by using a finite difference method and the ordinary differential equation system is solved through the Runge–Kutta method. Compressor behavior is simulated through steady-state maps both for normal and unstable operating regions. They also analyzed that through an experimental approach for stable and unstable operating conditions of compressor [19].

There are some other useful works in literature dealing with dynamic modeling of compression systems by different approaches. L. E Bakhen et al. reported testing and verification of compressor and driver integration with reference to transient behavior during shut down [20]. Venturini implemented a black-box approach to compression system dynamic simulation [21]. Moore et al. presented experimental transient compressor surge data on a full-scale test facility, which would be useful for transient models verification [22]. In [23], a dynamic simulation of multi-stage compressor trains is presented, and several simulation cases results are reported. Finally,

an application of dynamic modeling in compressor cycle optimization is presented in [24].

The present study focuses on developing an interactive simulation environment to study the dynamic behavior of a compression system in different modes of operation using a modular dynamic model. The dynamic simulator enables design and optimization of compressor anti-surge control system and includes other process equipment, governor and gas turbine driver models. The compression system model is physics-based, modular, non-linear and one-dimensional and the mathematical approach is based on the equations presented in reference [16, 17]. The system dynamic is solved by using a computational method in an in-house FORTRAN code. Compressor characteristics maps generated from company compressor test bench are used to determine compressor performance. The developed code was first used to simulate the compressor's dynamic performance in the company industrial test bench facility. In order to check the validity of the model, the simulation results are compared with experimental data. The resulting accuracy indicated that the developed code is capable of simulating the real compression plant with the anti-surge system. The simulation, within a wide range of operating conditions, also allows a parametric study to be performed and the optimal values of the control parameters to be selected.

Nomenclature

A	Duct Area
C_v	Valve Coefficient
D_h	Hydraulics Diameter
J	Moment of inertia
k	Specific heat ratio
\dot{m}	Mass flow rate
p	Pressure
R	Gas constant
T	Temperature
V	Velocity
w	Rotational speed
λ	Friction factor
ρ	Density
τ_c	Compressor torque

¹ Emergency ShutDown

τ_d Driver torque

Abbreviation

ODE Ordinary Differential Equation

Subscripts

i Initial

f Final

ID Inlet duct

OD Outlet duct

2. Experimental Arrangement

The model validation determines the degree to which a model is an accurate and credible representation of the real system. For this, an industrial compressor test bench instrumented with a data acquisition and processing system was developed. Performance and mechanical running test bench for centrifugal compressors had been already launched. Several machines of various capacities have been successfully tested at the local test bench. The test facility is equipped with a driving electromotor and a variable speed gearbox. Compressors of high velocity are tested using an accessory set-up gearbox coupled to the output shaft of this main gearbox.

The test bench facility is also equipped with air intake and exhaust system with varied dimensions to accommodate compressor inlet and outlet branch pipes of various diameter, flow rate control system, silencer, pressure, temperature and flow measuring instrumentation, integral lube oil system, remote control system, compressed air supplying system to feed the DGS² system, and base plates to accommodate machines of different sizes. All test bench equipment pieces and inlet/outlet accessories, as well as test instructions, follow the requirements of ASME PTC10. In particular, the facility was designed to perform compressor steady state characterization, such as specifying performance map and identifying compressor surge point. This facility has also been used to carry out dynamic analyses and dynamic simulation validation with investigating compressor behavior in unsteady conditions. The experimental arrangement is illustrated in Fig. 1.

² Dry Gas Seal

3. Model development

The model is modular; the modular system is defined properly connecting different components, which are individually described by the ordinary differential equations (ODEs) or algebraic equations. The dynamic behavior of the system is described by the gas properties values in the nodes connecting two modules. The mathematical model used in this paper was developed by researchers in Ref [12, 13], where the continuity and momentum conservation equations were utilized in their investigation. A typical schematic of a real industrial compression system is shown in Fig. 2.

Such system is composed of the compressor and the surrounding equipment likes gas cooler, scrubber, and a recycle line with a control valve for surge control. As said before, the main focus of this research is the development of a model based on the company test bench arrangement. The schematic of the system considered for code validation is presented in Fig. 3. The system is consist of an inlet duct, a compressor, an outlet duct, a electromotor driver and an outlet mass flow control valve. Each duct has constant section, and the compressor is considered as a quasi-steady element described by its steady state performance map.

The governing equations for one-dimensional unsteady fluid flow can be written in the differential form as

Continuity equation:

$$\frac{\partial \rho}{\partial t} + \frac{\partial(\rho V)}{\partial x} = 0, \quad (1)$$

Momentum equation:

$$\frac{\partial(\rho V)}{\partial t} + \frac{\partial(p + \rho V^2)}{\partial x} = -f_{fr}. \quad (2)$$

The rotational motion of the rotor is represented by

$$\frac{\partial \omega}{\partial t} = \frac{1}{J} (\tau_d - \tau_c). \quad (3)$$

Equation (3) represents the spool dynamics, J is the driver unit moment of inertia, τ_d is the supplied driver moment which is an input to the system, and τ_c is the torque on the shaft from the compressor.

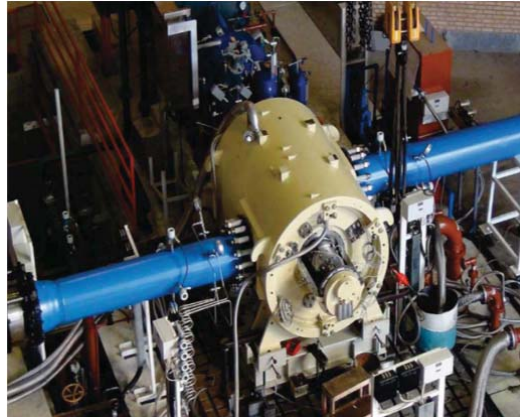

Fig. 1. A view of an industrial compressor test bench

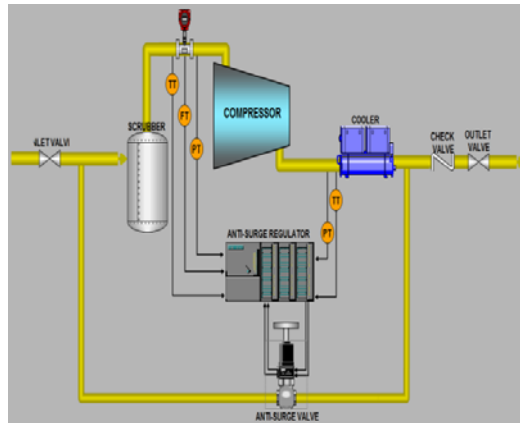

Fig. 2. A schematic of a real compression system in the site

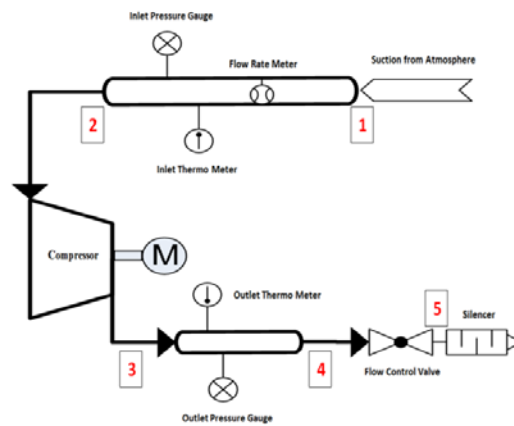

Fig. 3. A schematic of compression system in the test bench.

The final expression of governing equations for implementing in the FORTRAN code can be acquired by some assumption and simplification, as stated below [12]:

- The energy balance equation is not used,

- The compressor is modeled as a cylindrical element with length L , internal radius R_i and external radius R_o ,
- Assume Ideal Gas behavior with the equation of state given as $p = \rho RT$.

- Considering uniform gas properties on each section and only variable along the flow path (in *x*-direction)
- Assume isentropic flow:
 $p\rho^{-k} = const. \rightarrow dp = kRTdp$
- Express friction forces as
 $f_{fr} = \frac{\lambda}{D_h} \rho \frac{v^2}{2}$.

Based on these assumptions and by taking the Taylor series expansion of fluid flow equations with neglecting higher order terms, the mass and momentum equations become respectively as

$$\frac{\partial p_{i,f}}{\partial t} = \frac{kRT_{i,f}}{A_i A_f} \frac{A_f \dot{m}_i - A_i \dot{m}_f}{L} \quad (4)$$

$$\frac{\partial \dot{m}_{i,f}}{\partial t} = -\frac{A_{i,f}}{L} (p_f - p_i) - \frac{\lambda_{i,f}}{D_{hi,f}} \frac{RT_{i,f} \dot{m}_{i,f}^2}{2A_{i,f} p_{i,f}} \quad (5)$$

While “*i*” and “*f*” are the initial and final sections of the *L*-length duct, respectively. In order to find the gas properties in the nodes connecting two modules, Eqs. (4) and (5) are written for the numbered sections in Fig. 3. The required equations to solve the undetermined flow properties are presented in Table 1.

Based on the information in Table 1, the coupled system of ordinary differential and algebraic equations which represent the system dynamics is written as follow:

$$\frac{\partial p_2}{\partial t} = \frac{kRT_2}{A_2} \frac{\dot{m}_2 - \dot{m}_3}{L_C}, \quad (6)$$

$$\frac{\partial p_3}{\partial t} = \frac{kRT_3}{A_3} \frac{\dot{m}_3 - \dot{m}_4}{L_{OD}}, \quad (7)$$

$$\frac{\partial \dot{m}_1}{\partial t} = -\frac{A_1}{L_{ID}} (p_2 - p_1) - \frac{\lambda_1}{D_{h1}} \frac{RT_1 \dot{m}_1^2}{2A_1 p_1}, \quad (8)$$

$$\frac{\partial \dot{m}_2}{\partial t} = -\frac{A_2}{L_{ID}} (p_2 - p_1) - \frac{\lambda_2}{D_{h2}} \frac{RT_2 \dot{m}_2^2}{2A_2 p_2}, \quad (9)$$

$$\frac{\partial \dot{m}_4}{\partial t} = -\frac{A_4}{L_{OD}} (p_4 - p_3) - \frac{\lambda_4}{D_{h4}} \frac{RT_4 \dot{m}_4^2}{2A_4 p_4} \quad \text{and} \quad (10)$$

$$\frac{\partial \omega}{\partial t} = \frac{1}{J} (\tau_d - \tau_c). \quad (11)$$

With Eqs. (8) and (9), the mass flow at Sections 1 and 2 are different to consider the mass storage effects by the model. For small volume, it is better to implement one of them to decrease the code running time.

Four algebraic expressions are also needed to calculate T_3 , \dot{m}_3 , p_3 and τ_c . With considering the inlet air as a combination of mole fractions of N₂, O₂, CO₂, H₂O and Ar, preferring polytropic efficiency than isentropic efficiency for compressor outlet temperature calculation, and also using the first and the second law of thermodynamics, then.

$$\int_{T_2}^{T_3} \bar{c}_{PM} \frac{dT}{T} = \int_{p_2}^{p_3} \frac{R}{\eta_{\infty c}} \frac{dp}{p} = \frac{R}{\eta_{\infty c}} \int_{p_2}^{p_3} \frac{dp}{p}. \quad (12)$$

All parameters in the right hand side of Eq.(12) have been determined, so it is calculated by using one simple integration. The compressor outlet mass flow, calculated from the manufacturer generated compressor map. That is

$$\dot{m}_3 = \text{MAP} \left(\frac{p_3}{p_2}, \omega \right). \quad (13)$$

The compressor absorbed moment is calculated as

$$\tau_c = \frac{\dot{m}_3 \int_{T_2}^{T_3} \bar{c}_{PM} dT}{\omega MW_{air}}. \quad (14)$$

The valve outlet pressure is simulated through

$$\rho p_4 = p_{amb} + \frac{\dot{m}_4^2}{\rho_4 C_v^2}. \quad (15)$$

The input values for ambient pressure and temperature, geometrical parameters, valve coefficient and friction factors are given in Table 2.

Table 1. The required equations to solve flow properties

Section Number	Pressure Value	Temperature Value	Mass Flow Value
1	ambient	Ambient	Eq. (8)
2	Eq. (6)	Ambient	Eq. (9)
3	Eq. (7)	Eq. (12)	Compressor Map
4	Valve equation	equal to T_3	Eq. (10)
5	Ambient	Ambient	equal to \dot{m}_4

Table 2. Model Inputs

Model Parameter	Value	Unit
Ambient Pressure	87	kPa
Ambient Temperature	41	K
Inlet pipe length	24.5	M
Outlet pipe length	13	M
Compressor length	0.8	M
Pipes hydraulic diameter	0.55	M
Control valve Cv	4400	-
Friction factors	1,1,4	-

The system dynamic is solved by using a computational method in an in-house FORTRAN code. Library subroutine IMSL, which solves an initial-value ODE problem by using the Runge-Kutta method is utilized for this purpose. The routine finds an approximation to the solution of a system of first-order differential equations with given initial data. The relative error is controlled within a user-supplied limit.

4. Compressor performance map

As stated in the previous section, the compressor performance map is used for mass flow calculations with identifying the design parameters. The conventional map is usually a plot of pressure ratio versus corrected flow for constant corrected speed lines (Fig. 4). Compressor characteristics maps generated from company compressor test bench are used to determine compressor pressure ratio and efficiency. From the test, five constant speed lines of the steady-state map are obtained by experiment. So, an approximation of the compressor map for other speeds in the direct-flow region is derived by utilizing a second order polynomial curve fitting tool in Matlab. The performance map could be approximated by third order polynomial to cover unstable region at the left side of the surge line.

However, the current study is focused only on normal operational region, and second order approximation accuracy is sufficient for this purpose. The symbols in Fig. 4 represent experimental steady state performance and the lines are the corresponding curves generated with the polynomial.

5. Results

Using the procedure mentioned in the previous sections, to verify the developed compression system dynamic simulation code, the flow in the company compressor test bench was simulated for two test scenarios. In Scenario 1, the outlet valve opening (opening position) is fixed, but the compressor speed can vary. In Scenario 2, the valve position is variable, and hence the flow is variable. In the later, the compressor speed is not necessarily constant, but the tests show minimal speed changes. The operating data were collected from test bench PLC and HMI systems with a sampling rate of 0.5 second. Figure 5 shows compressor speed variations versus time for Scenario 1, and Fig. 6 shows outlet valve position variations for Scenario 2.

In Scenario 1 (Fig. 5), the compressor operates in steady state with 6980 rpm, then the speed reduced to 4885 rpm and again returned to its first 6980 rpm. During this test, the outlet valve position is held fixed at 6.5 percent. For this condition, the pressure and mass flow at Section 1 and pressure at Section 2 are compared with the test measured data. The results are presented in Figs. 7, 8 and 9. All the graphs values are normalized by its value at the design point. As can be seen, the obtained trend and values show a high degree of accuracy of the simulation. The air flow parameters values are accurate within an average error of less than 4.5 percent. The percentage of deviation from the test data is listed in Table 3. It can be seen that the maximum deviation from the experimental data is less than 8%. Since there is not a noticeable delay between the model and the compression system response, one should observe that the model results closely follow the test data.

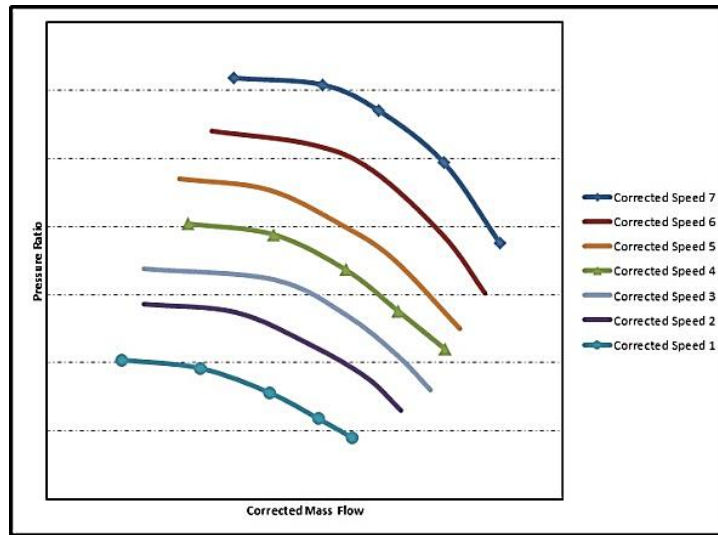

Fig. 4. A schematic of the compressor performance map

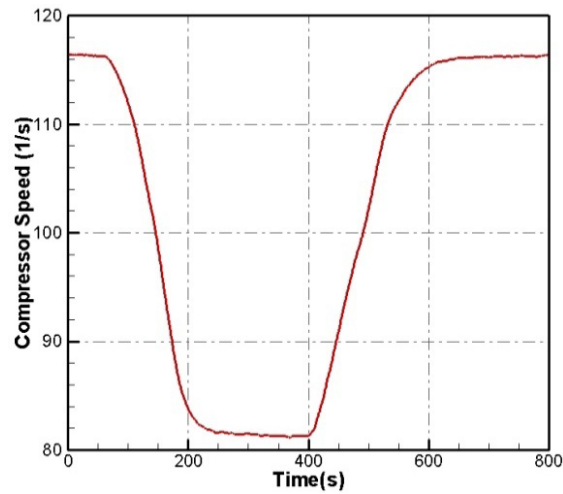

Fig. 5. Compressor speed variation during Scenario 1

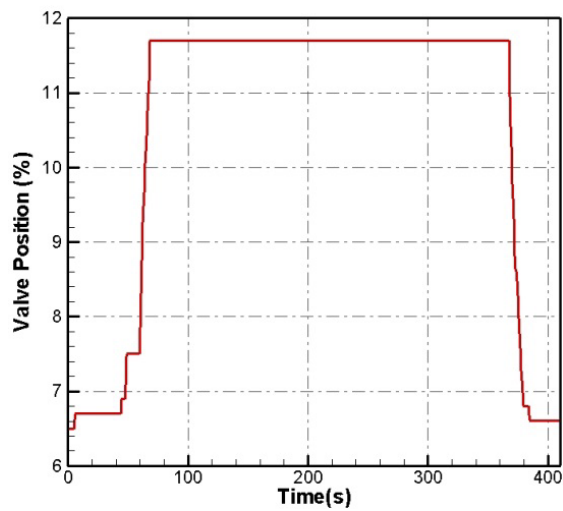

Fig. 6. Valve position variation during Scenario 2

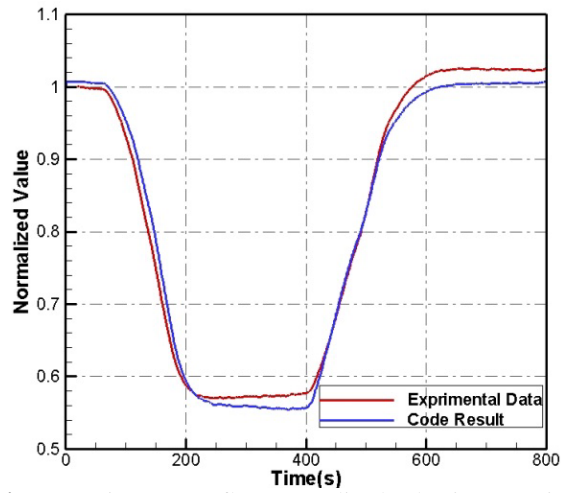

Fig. 7. Section 2 mass flow normalized value in Scenario 1

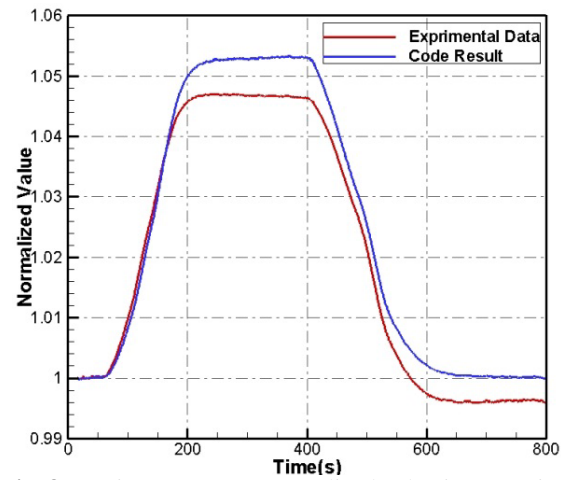

Fig. 8. Section 2 pressure normalized value in Scenario 1

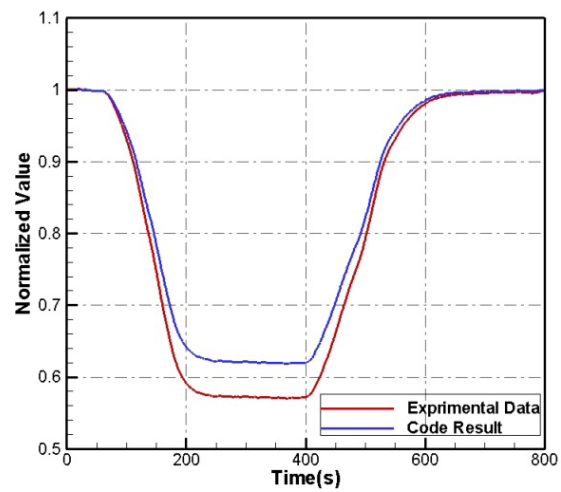

Fig. 9. Section 3 pressure normalized value in Scenario 1

Table 3. Average and maximum error percent

Parameter	Average Error%	Maximum Error %
Mass flow at Section 2 in Scenario 1	2.3	5.4
Pressure at Section 2 in Scenario 1	0.35	0.66
Pressure at Section 3 in Scenario 1	4.5	6.5
Mass flow at Section 1 in Scenario 2	3.0	7
Pressure at Section 1 in Scenario 2	0.4	7
Pressure at Section 3 in Scenario 2	4.5	8

In Scenario 2 (Fig. 5), the outlet valve is opened from position 6.5% to 9% and then closed to its first position.

Figures 10 to 12 compare the modeled flow parameters and the corresponding measurements during the second test scenario.

The deviation percentage from the test data is also listed in Table 3. All the results of Scenarios 1 and 2 validate the accuracy of the developed compression dynamic simulation code.

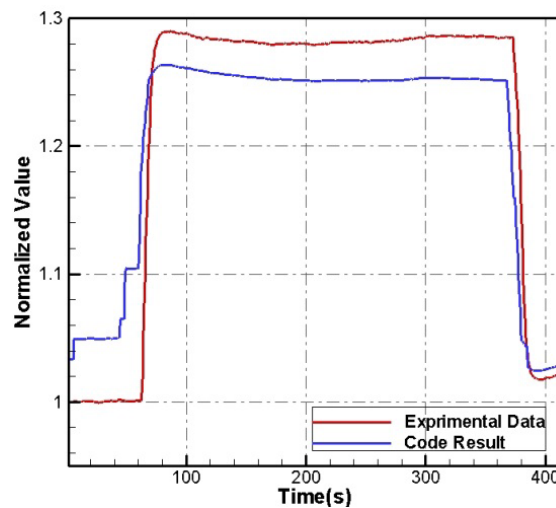

Fig. 10. Section 2 mass flow normalized value in Scenario 2

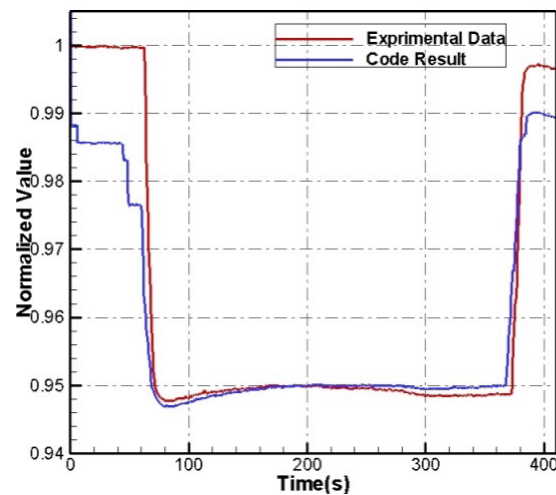

Fig. 11. Section 2 pressure normalized value in Scenario 2

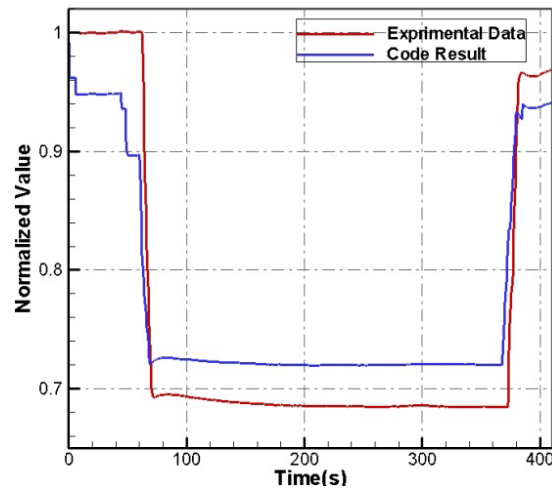

Fig. 12. Section 3 pressure normalized value in Scenario 2

6. Conclusion

The present study focuses on developing an interactive simulation environment to study the dynamic behavior of a compression system in different modes of operation using a modular dynamic model. The main focus of this research is development of a model, based on MAPNA (TUGA) test bench arrangement. For this purpose, a physics-based and modular dynamic model of a compression system was developed based on laws of conservation. The system dynamic equations are solved by using a computational method in an in-house FORTRAN code, and the simulation results are then compared with experimental data taken on the company industrial compressor test facility. The validation agreement then demonstrates the overall validity of the developed code in the dynamic simulation of the large compression system in industrial plants.

Acknowledgment

This research was conducted in MAPNA Turbine Engineering & Manufacturing Co. (TUGA), under Turbo-compressor Simulator Development Project. The authors would like to express their gratitude to all contributors.

References

- [1] Mickers R.W., Comparative parameter studies of dynamic models for centrifugal compression systems, Master Thesis, Technische Universities Eindhoven (2006).
- [2] Gravidahl T., Egeland O., Compressor Surge and Rotating Stall Modeling and Control, London, UK, Springer (2012).
- [3] Greitzer E. M., Surge and rotating stall in axial flow compressors, part 1, 2, ASME Journal of Engineering for Power 120: 190–217(1976).
- [4] Hansen K. E., Jørgensen P., Larsen P. S., Experimental and theoretical study of surge in a small centrifugal compressor ASME Journal of Fluids Engineering, 391–395(1981).
- [5] D. A. Fink, N. A. Cumpsty, and E. M. Greitzer, “Surge dynamics in a free-spool centrifugal compressor system,” ASME Journal of Turbomachinery, vol. 114, pp. 321–332, 1992.
- [6] J. T. Gravidahl and O. Egeland, “Centrifugal compressor surge and speed control,” IEEE Transactions on Control Systems Technology, vol. 7, pp. 567–579, 1999.
- [7] CJ Backi, JT Gravidahl, S Skogestad, “[Robust control of a two-state Greitzer compressor model by state-feedback linearization](#)” IEEE Conference on Control Applications (CCA), 2016.
- [8] N Uddin, JT Gravidahl, “[Active compressor surge control system by using piston actuation: Implementation and experimental results](#)”, IFAC-PapersOnLine, 2016.

- [9] Giampaolo Torrisi, Sergio Grammatico, Manfred Morari, Roy S. Smith, "Model Predictive Control approaches for Centrifugal Compression Systems" IEEE 54th Annual Conference on Decision and Control (CDC), 2015.
- [10] J. v. Helvoirt and B. d. Jager, "Dynamic model including piping acoustics of a centrifugal compression system," *Journal of Sound and Vibration*, vol. 302, pp. 361–378, 2007.
- [11] Botros, K.K., "Transient Phenomena In Compressor Stations During Surge", *J. of Eng. for Gas Turbine and Power*, vol. 116, pp. 133-142, January, 1994.
- [12] Botros, K.K., Campbell, P.J. & Mah, D.B., "Dynamic Simulation of Compressor Station Operation Including Centrifugal Compressor & Gas Turbine", *ASME Journal of Engineering for Gas Turbines and Power*, Vol. 113, pp. 300-311, April, 1991.
- [13] F. K. Moore and E. M. Greitzer, "A theory of post-stall transients in axial compressor systems: part i—development of equations," *ASME Journal of Engineering for Gas Turbines and Power*, vol. 108, pp. 68– 76, 1986.
- [14] Botros, K.K. and Ganesan, S.T., "Dynamic Instabilities in Industrial Compression Systems with Centrifugal Compressors", *Proceedings of the 37th Turbomachinery Symposium*, George R. Brown Convention Center, Houston, Texas, September 8-11, 2008.
- [15] [K. K. Botros](#), [B. Ruggiero](#), [M. Szwarc](#) and [C. Ho](#), "Dynamics of the Recycle Systems of Two Centrifugal Compressors Operating in Series in a Natural Gas Compressor Station" 10th International Pipeline Conference, 2014.
- [16] Venturini, M., "Development and Experimental Validation of a Compressor Dynamic Model," *ASME J. Turbomach.*, 127, pp. 599–608, 2005.
- [17] Morini, M., Pinelli, M., and Venturini, M., 2007, "Development of a One-Dimensional Modular Dynamic Model for the Simulation of Surge in Compression Systems," *ASME J. Turbomach.*, 129, pp. 437–447.
- [18] Morini, M., Pinelli, M., and Venturini, M., "Application Of A One-Dimensional Modular Dynamic Model For Compressor Surge Avoidance", *ASME Paper GT2007-27041*, 2007.
- [19] [Enrico Munari](#), [Mirko Morini](#), [Michele Pinelli](#), [Pier Ruggero Spina](#) and [Alessio Suman](#), "Experimental Investigation of Stall and Surge in a Multistage Compressor", *J. Eng. Gas Turbines Power* 139(2), 2016.
- [20] Bakken, L.E., Bjørge, T., Bradley, T.M., Smith, N, "Validation of Compressor transient behavior", *ASME Paper GT-2002-30279*, 2002.
- [21] M. Venturini., "Simulation of Compressor Transient Behavior Through Recurrent Neural Network Models", *ASME Paper GT2005-68030*, 2005.
- [22] J. Jeffrey Moore, Rainer Kurz, Augusto Garcia-Hernandez and Klaus Brun, "Experimental Evaluation of the Transient Behavior of a Compressor Station During Emergency Shutdowns ", *ASME PaperGT2009-59064*, 2009.
- [23] Garcia-Hernandez, eodoreSeanTavares and Melissa Wilcox, "Dynamic Pipeline System Simulation of Multi-Stage Compressor Trains", *ASMEGT2012-70072*, 2012.
- [24] Viktor Kilchyk, Ahmed Abdelwahab and Andrew Rosinski, "Application of the Surge Model to Radial Compressor System Cycle Optimization", *ASME Paper GT2013-94222*, 2013.