

## Effect of impeller geometry on performance characteristics of centrifugal compressor

### Author

Aria Sobhani<sup>a\*</sup>  
Hamidreza Pourtaba<sup>a</sup>  
Tayebeh Amini Nouri<sup>a</sup>

<sup>a</sup> MAPNA Turbine Engineering and Manufacturing Company (TUGA), Tehran, Iran

### ABSTRACT

*Centrifugal Compressors play an essential role in oil, gas and petrochemical industries. Their extensive usage is due to their smooth operation and high reliability compared to other other compressor types. One of the main characteristics of these turbomachines is their performance curve, which is an important criterion for selecting the appropriate compressor for a desired working condition. In the presented article, the effect of impeller's geometry on performance curve and other compressors characteristics is numerically investigated. The 3D CFD code is used to achieve the performance curves that are dedicated to each geometrical configuration. The results indicate that some of the selected geometrical parameters have a significant effect on performance curve margins. Increasing the shroud angle moves the surge point to the higher flow coefficients, while the pressure ratio remains constant and increasing the blade's trailing edge angle, leads to increase in pressure ratio.*

### Article history:

Received : 1 August 2018

Accepted : 16 February 2019

**Keywords:** CFD, Centrifugal Compressor, Optimization.

### 1. Introduction

Computational fluid dynamics is considered as a reliable tool for predicting performance of turbomachines and investigating their behavior in different operating conditions. Generally speaking, CFD simulation of turbomachines can be divided into two main categories, steady state and transient. Due to the transient behavior of fluid flow in centrifugal compressors, transient simulation provides a more accurate results comparing to steady state simulation especially close to the surge point, but it needs a great computational effort which makes it impractical in most industrial applications. On the other hand, steady state

simulation has been widely accepted as a common way for computational analysis of centrifugal compressors because it provides an acceptable accuracy with lower computational cost.

In last few years, many numerical studies have been implemented thanks to the improvements of computational resources [1]. Integrated the CFD design process with preliminary aerodynamic design. With Examples drawn from industry, they showed how to illustrate the current state of the art of CFD and FE as applied to turbochargers and industrial compressors. Furthermore [2] implemented several CFD analyses of a centrifugal compressor stage with different techniques to model the rotor-stator interaction. They compared conventional steady stage calculations (with a mixing-plane type interface between the rotor and

\* Corresponding author: Aria Sobhani  
MAPNA Turbine Engineering and Manufacturing Company (TUGA)  
Email: Sobhani.Aria@mapnaturbine.com

stator) with transient methods and they illustrated that the steady state simulation can give excellent agreement with the measured performance characteristics at design speed, demonstrating the ability of steady simulation to capture the essential features of the blockage interaction between the components.

Numerical model Accuracy is extremely related to the applied turbulent model. [10] Assessed the turbulence model predictions for a centrifugal compressors and they illustrated that while all models provide an acceptable prediction of performance curves, the SST model shows reasonably stable, robust and time efficient capability to predict global performance and local flow features.

Transient simulations of centrifugal compressors have been widely investigated as well. [3] Numerically investigated the unsteady flow field of a centrifugal compressor stage with a vaned diffuser. They compared numerical simulations to the experiments in the compressor map and discussed similarities and differences between numerical and experimental results. [4] also investigated the onset of instability in a shrouded vaned diffuser from a highly loaded turbocharger centrifugal compressor and they discussed the mechanisms thought to be responsible for the development of short-wavelength stall precursors.

Numerical simulations can provide us with many benefits in optimization processes. Lots of investigations are dedicated to increasing the efficiency of operating compressors due to financial and environmental concerns. As an example [5] presented the numerical analysis and aerodynamic optimization of a return channel system and U-turn for multi-stage single shaft centrifugal compressor. Results were achieved by steady state solution and they showed a reduction of total pressure loss by 3% for the optimized blade shapes compared to a standardized blade shape of constant change of tangential momentum. Further studies are implemented to investigate the effect of leakages within the compressor on efficiency and performance curves by [6], [7] and [8].

According to the operating conditions, the working fluid can be treated as a real or an ideal gas, which can significantly affect the results; therefore it is essential to apply the appropriate equation of state while simulating the fluid flow. Most of the investigations available in the literature are provided with the assumption of ideal gas due to the ease of convergence and computational effort, but there are as well studies about simulating the real gas behavior [9].

In the presented study, the effect of impeller's geometry on the multi-stage compressor performance curve (shifting it toward surge or choke e point) is numerically investigated. The four-stage centrifugal compressor is simulated and the working fluid is considered to be a real gas. Geometry is parametrized in both meridional and blade to blade planes and various case studies are provided. In the next step, A 3D computational fluid dynamic code (ANSYS-CFX16) is used to achieve the performance curves that are dedicated to each geometrical configuration.

## 2. Computational method

In the presented work, the simulation is performed by applying steady state, implicit solution and the second order Up-Wind method is considered as a discretization scheme. The parallel processing is implemented for the sake of saving time and the METIS Grid Partitioning Methods is used for mesh partitioning. Furthermore, Peng-Robinson equations of state are used for modeling real gas properties and the time scale is set to be equal to  $0.1/\omega$ , where  $\omega$  is the rotational speed of the compressor. Finally, for modeling the turbulence the SST (Shear Stress Transport) method is implemented due to its favorable features [10].

### 2.1. Rotor- Stator Interface

Defining the interface between rotary and stationary components is one of the most important strategies that should be considered during CFD simulation. Generally, there are three options available for modeling interfaces

between rotors and stators, Stage, frozen rotor and Transient Rotor-Stator (TRS) interface method. In the presented work, the stage interface is applied for each pair of rotor/stator interface. This interface uses the mixing plane strategy for connecting rotary and stationary pairs together by circumferential averaging the transported quantities in each component interface.

## 2.2. Geometry

Figure 1 and Fig. 2 show the three dimensional and meridional view of the compressor, respectively. The geometry is dedicated to a four-stage centrifugal compressor, and it contains impellers, diffusers and return

channels for each individual stage (except for the last stage that does not have a return channel). Since investigating the geometry of Stationary parts is not the interest of presented study, only the impellers geometry is parametrized; and furthermore, four independent parameters are defined for its geometry: shrouds curve radius, hub curve radius, shroud verticals angle and blades trailing edge angle (Fig. 3). As it is evident, impeller's meridional and blade to blade geometry needs more than these parameters to be fully defined but defining all geometrical variables is impractical and computationally expensive hence the mentioned parameters are selected between all possible alternatives.

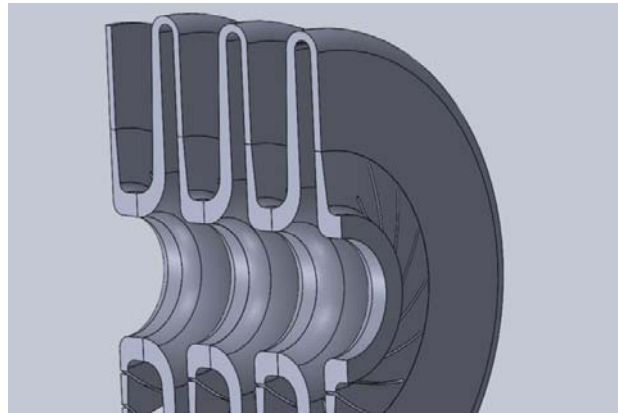

**Fig.1.** Three dimensional of compressor

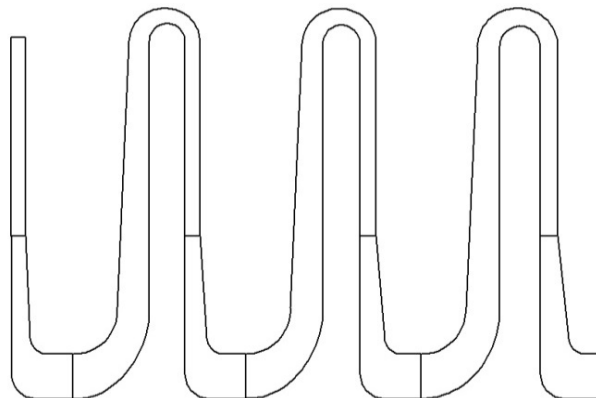

**Fig.2.** Meridional View of the Compressor

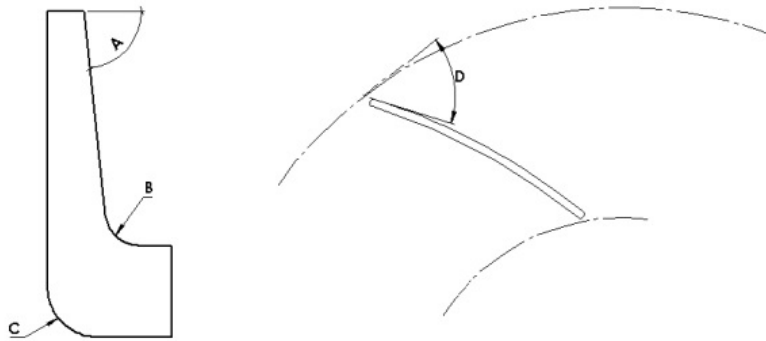

**Fig.3.** Parametrized Geometry

2.3. Meshing

ANSYS-Turbogrid software was used to generate the hexahedral mesh with sufficient near wall quality for each component (Fig.4). The mesh was provided in 3 different qualities, and the FINE mesh was selected according to its favorable characteristics (Table1) (i.e., Maximum aspect ratio, grid angle and  $y^+$ ).

For all case studies, inlet total pressure and temperature are defined as inflow B.C; and for outflow condition, either a mass flow outlet or static pressure is used depending on the point's position on the performance curve. In other words, for flow coefficients less than design points flow coefficient, the mass flow outlet is set because it is more stable near surge line, and the averaged static pressure is set for higher flow coefficient (near to choke line).

2.4. Boundary Conditions

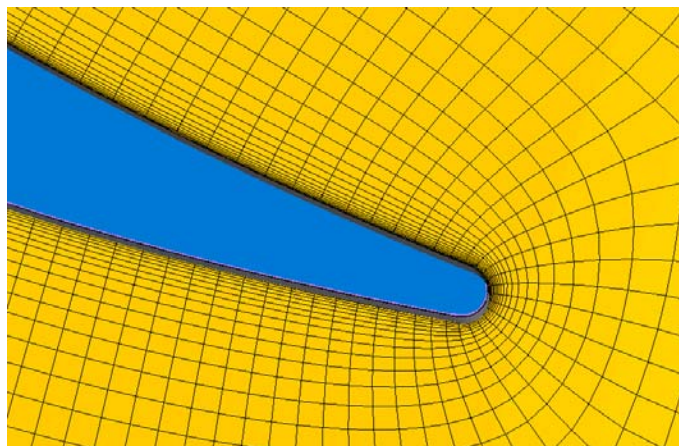

**Fig.4.** Generated mesh near walls

**Table 1.** Mesh characteristics for each component

	Coarse	Medium	Fine
<b>Nodes</b>	100325	230589	560365
<b>Max. aspect ratio</b>	1965	2683	3012
<b>Min. grid angle</b>	16.1	16.32	16.34
<b>Y+</b>	2.5	1.5	1

2.5. Case Studies

Table 2 presents the case studies, generated according to Fig.3. Each parameter contains three magnitudes (except parameter D). In each case study, one of these parameters is set to be variable while other parameters are set to be constant (i.e., equal to their magnitude in base geometry). Finally, it must be mentioned that due to geometrical constraints, decrement in blades trailing edge angle is impossible, so for parameter D only Base and Max geometries are considered.

2.6. Convergence Criteria

As it is shown in Fig.5, the converged solution is considered to be achieved when the residuals are equal to or less than  $10^{-5}$ . Monitoring the flow's favorable features such as efficiency and outlet pressure may be a practical way to examine the results as well.

2.7. Validation

In order to verify the reliability of the numerical simulation, experimental data is compared to the numerical results in the design point operating condition. Table 3 presents the amount of deviation around the design flow rate for the in house manufactured compressor.

Table 2 . Case studies

Parameter	Min( $\times$ Base)	Base	Max( $\times$ Base)
A	0.8821	1	1.023
B	0.36	1	1.79
C	0.5	1	1.5
D	-	1	1.23

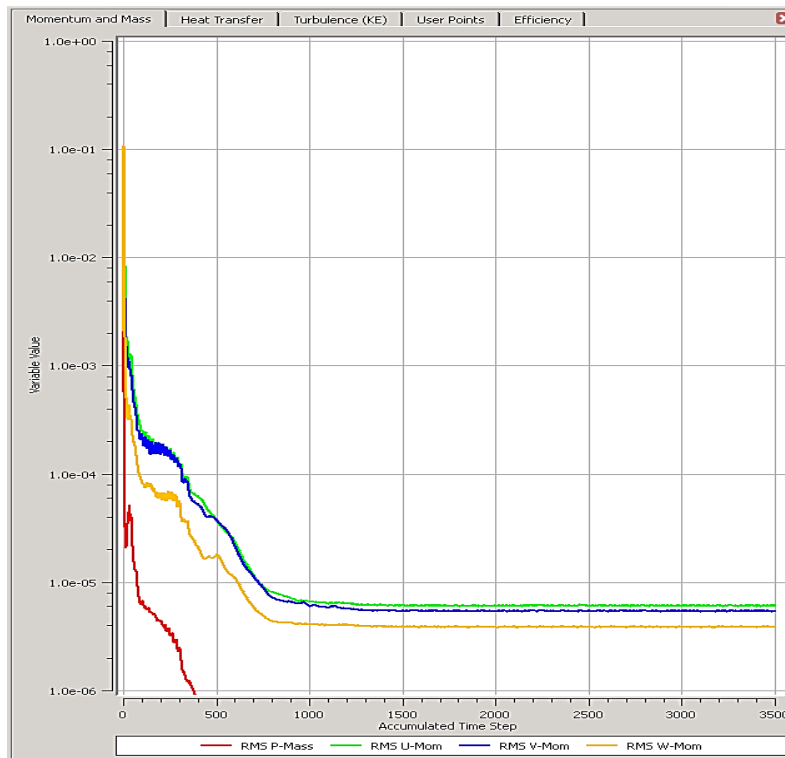

Fig.5. Residuals Vs. Iterations

As it is shown, the maximum amount of deviation is dedicated to the prediction of the outlet total pressure, which is overestimated around two percent. This inaccuracy might be due to the fact that some internal leakages and Surface roughness of compressor are not modelled and considered in the numerical simulation.

Figure 6 shows factories test bench where experiments are conducted. It must be mentioned that the installation of all measuring instruments and data reading process is in accordance with ASME- PTC10.

### 3. Results and Discussion

#### A) Shroud Angle

Figure 7 and 8 show the effect of Shroud angle on compressors performance curves. As it is illustrated, increasing shroud angle increases the choke margin while maintaining the surge point constant which improves the compressors operating envelope in all four stages.

It must be mentioned that the maximum magnitude of polytropic efficiency and head coefficient remain constant regardless of any

changes in shroud angle (which are 90 % and 0.52 respectively) it means that this geometrical parameter can only move the performance curves toward the right or left side (lower or higher flow coefficients) and cannot increase compressors Max pressure ratio and polytropic efficiency.

#### B) Shroud Curve

Figure 9 shows the effect of shroud curve on the compressor polytropic efficiency. As it is obvious, while changing the curves radiuses does not affect compressors envelope significantly, it can improve the polytropic efficiency (in high flow coefficients), and this phenomenon is more visible in downstream stages.

Figure 10 shows the effect of shroud curve on the compressor head coefficient. In low flow coefficient region, changing the shroud curves radiuses does not affect the achieved pressure ratio but in higher flow coefficient, (i.e., near choke margin) increasing the radiuses leads to the higher head coefficients.

It means that the base design meridional geometry can be optimized by increasing the shroud curves radiuses in all four stages.

Table 3. Data Deviation

Variable	Numerical Result	Experimental Results
Mass Flow Rate	1	1
Outlet Temperature	1.0135	1
Outlet pressure	1.021	1
Pressure Ratio	1.0223	1

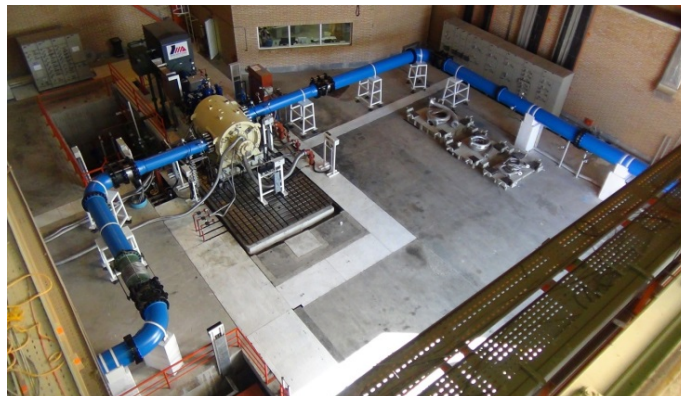

Fig.6. Compressor Test Rig



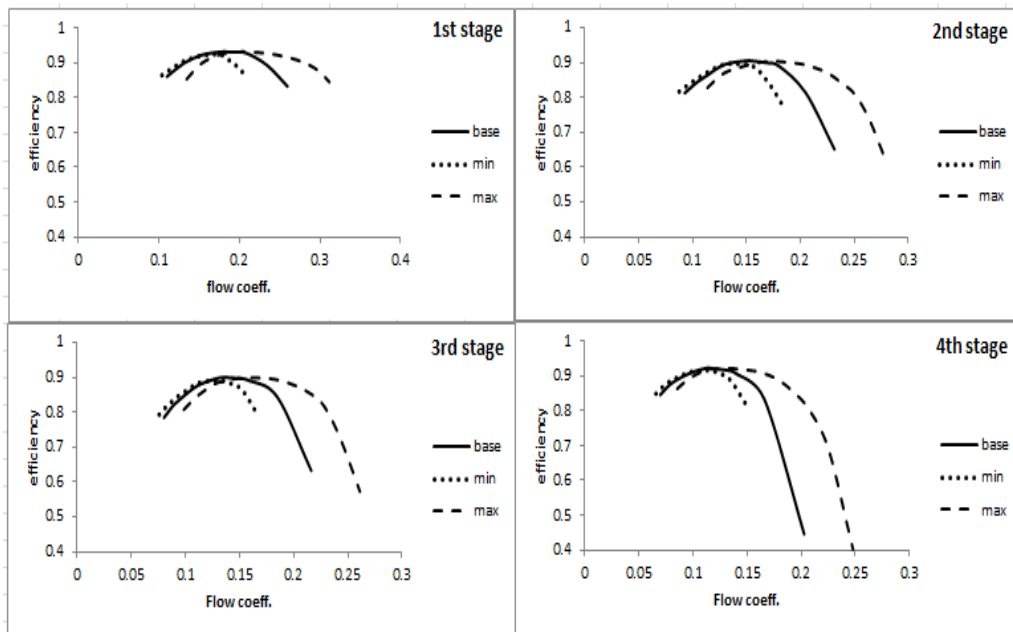

Fig.7. Effect of the Shroud Angle on the Polytropic Efficiency of Each Stage

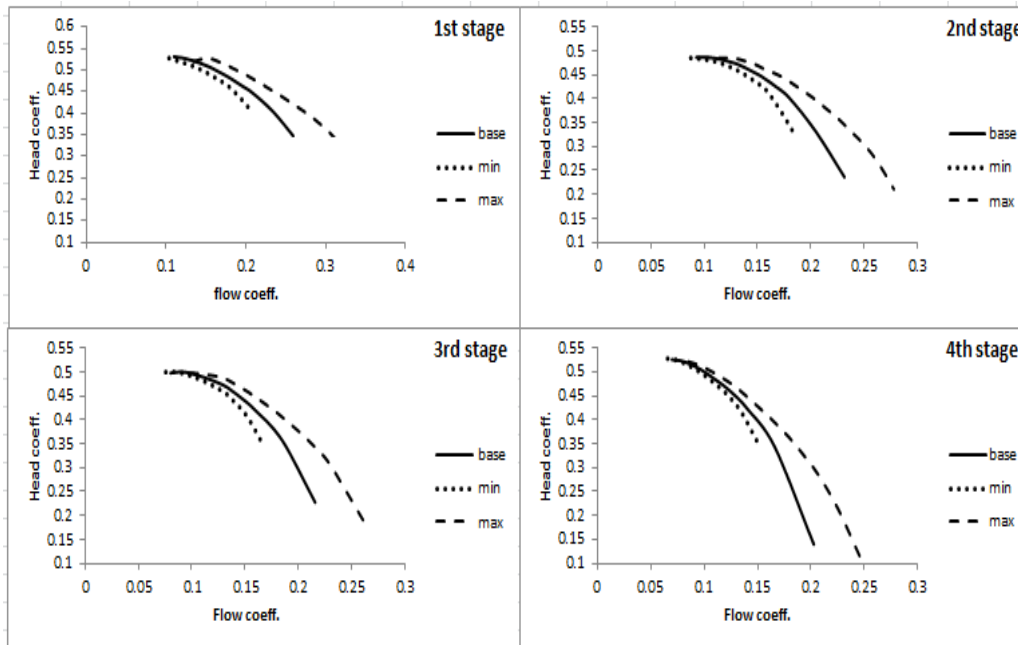

Fig.8. Effect of the parameter A on the Head Coefficient of Each Stage

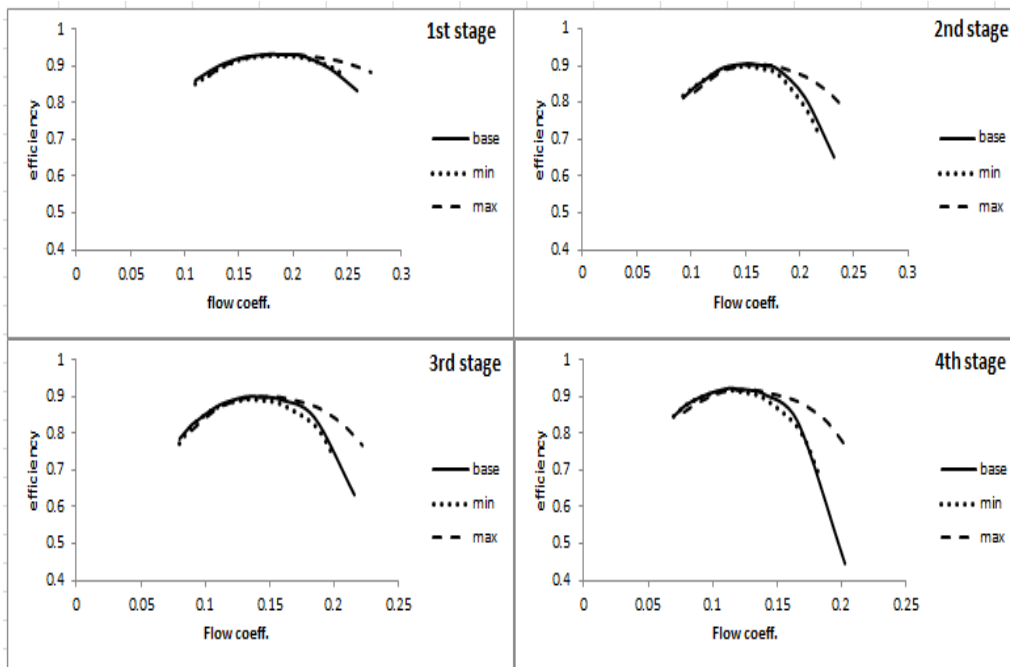

Fig.9. Effect of the Shroud curve on the Polytropic Efficiency of Each Stage

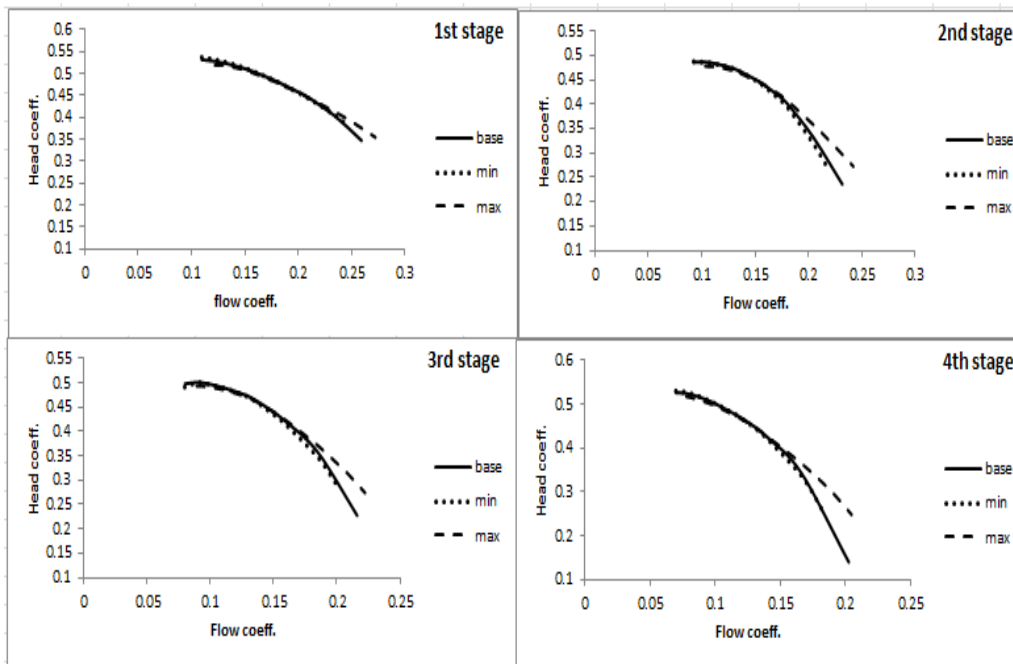

Fig.10. Effect of the Shroud curve on the Head Coefficient of Each Stage

C) Hub Curve

Figure 11 and Fig.12 show the effect of hub curve on each Stages Polytropic Efficiency and

head coefficient, respectively. The results indicate that this parameter has no sensible effect on compressors performance characteristics.



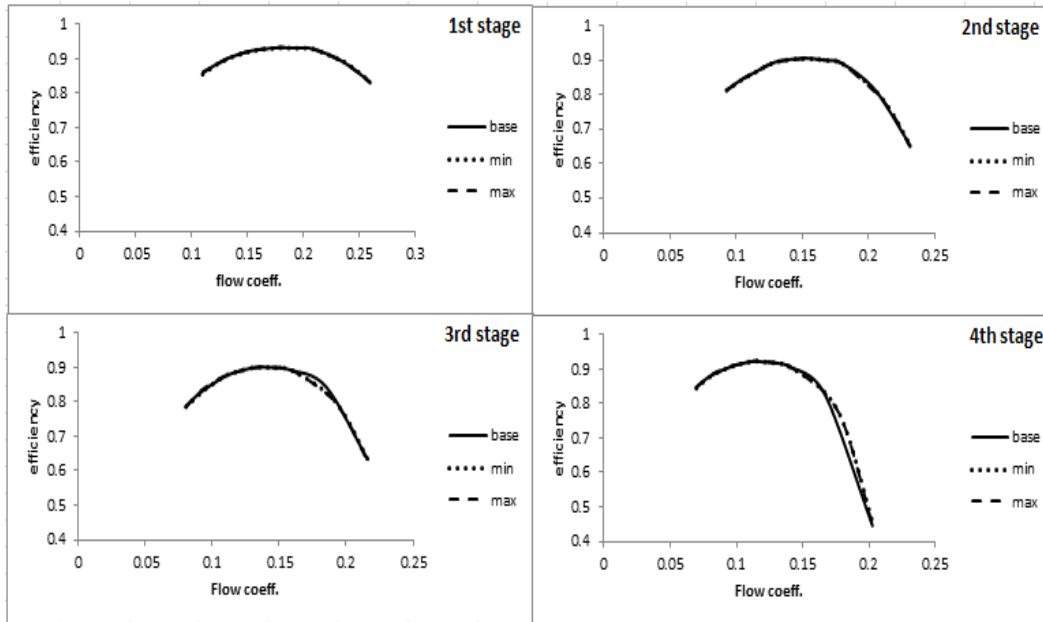

Fig.11. Effect of the Hub curve on the Polytropic Efficiency of Each Stage

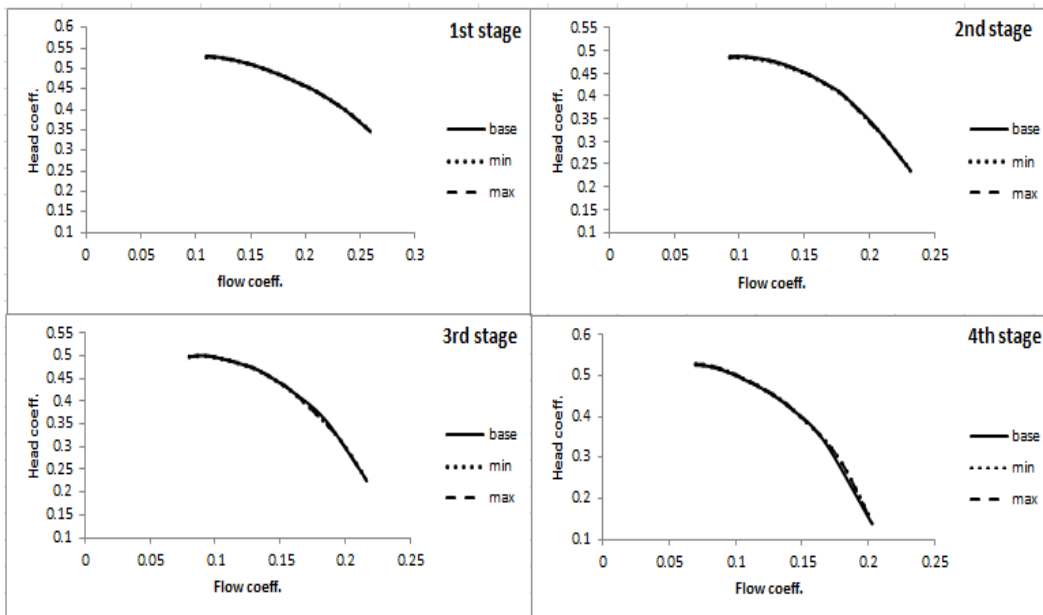

Fig.12. Effect of the Hub curve on the Head Coefficient of

#### 4.Each Stage

All three parameters which are discussed above belong to the meridional plane of the impellers; and as it is shown, while they have a significant effect on compressors operating envelope and choke margin, they cannot create notable changes in achieved pressure ratio in

near surge flow coefficients. In other words, while the shroud angle can transfer the surge point toward lower or higher flow coefficients it cannot increase/decrease the achieved pressure ratio in near surge flow coefficients. Therefore the last geometrical parameter is dedicated to the blades trailing edge angle, which helps to define impellers blade to blade

geometry and seems to play an essential role in the performance characteristics of compressor.

A) Blades trailing edge angle

Figure 13 shows the effect of blades trailing edge angle on the polytropic efficiency of each

stages. The results indicate that while increasing this angle does not affect the magnitude of efficiency in near surge operating condition; it can affect the choke region strongly by decreasing compressors choke margin and polytropic efficiency.

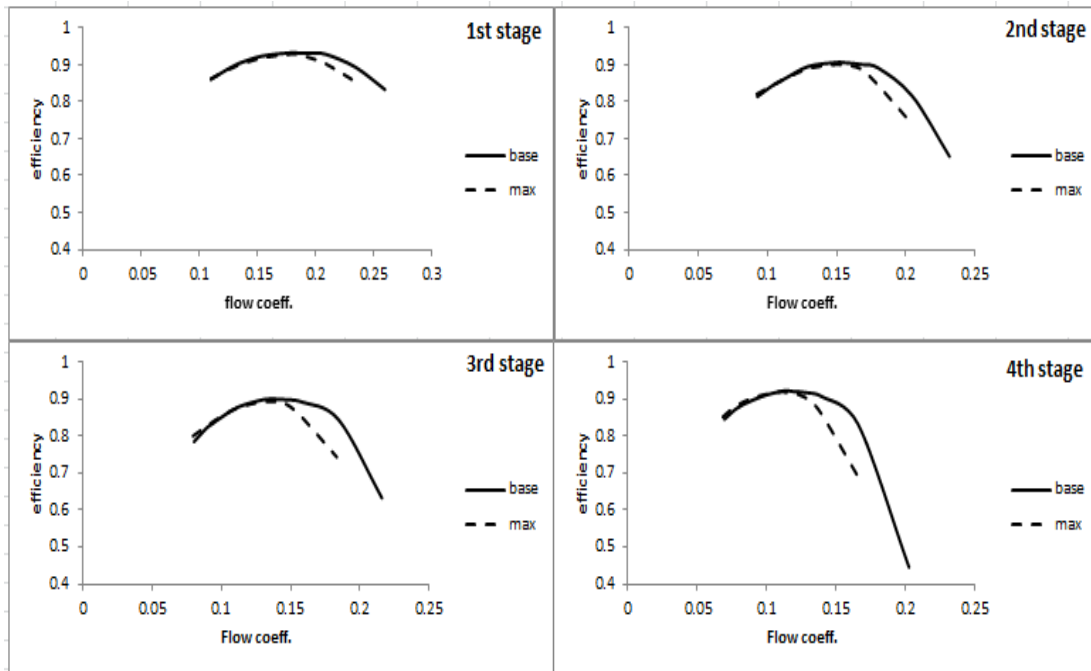

Fig.13. Effect of the Blade's trailing edge angle on the Polytropic Efficiency of Each Stage

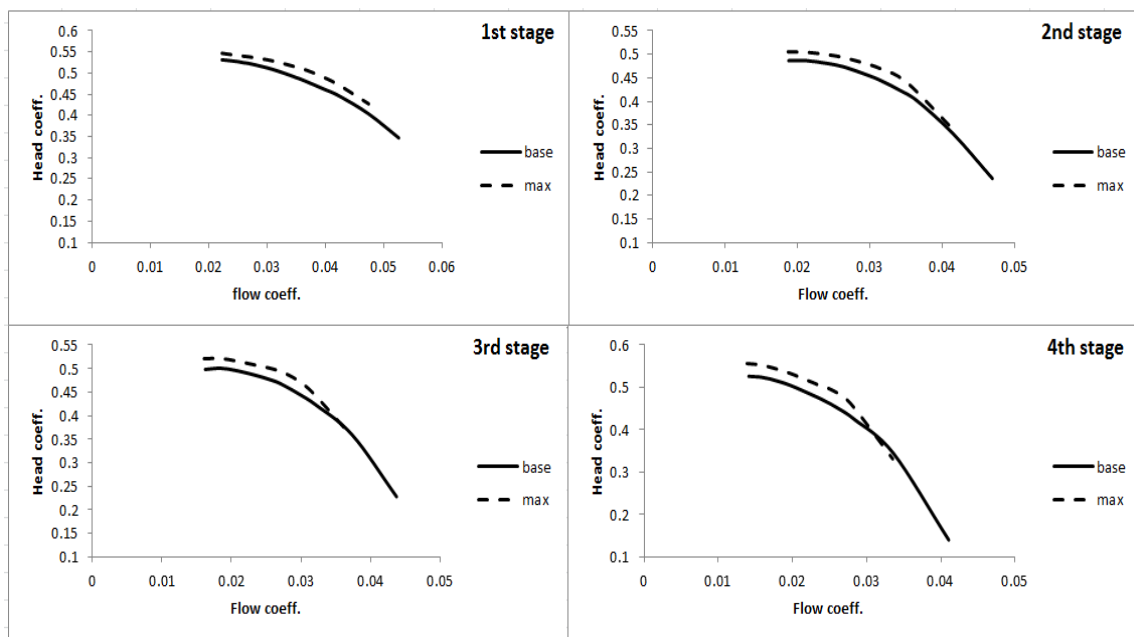

Fig.14. Effect of the Blade's trailing edge angle on each Stages Head Coefficient

### 5.Design process Optimization

In the ordinary design method, the through flow simulation is conducted in the meridional plane, and the geometry is changed in the reciprocating process until the desired outlet conditions are obtained. The through flow simulation does not consider the viscous terms of fluid flow, hence there is a great amount of inaccuracy in the results. On the other hand using the full Navier–Stokes equations for a considerable number of geometries that are generated by DOE schemes (design of experiment) is time consuming and impractical hence by considering the effect of each individual piece of meridional or blade to blade geometry, one may eliminate the number of preliminary geometries and use the full 3D Navier–Stokes equations to achieve reliable results. It means that the primary geometry may be estimated more significantly if the role of each individual portion of it on performance parameters of the compressor is well investigated.

### 6.Conclusion

In the presented study, the effect of impeller's geometry on a 4-stage compressor performance curve is numerically investigated. Four parameters are defined to parametrize each impeller's geometry (meridional and blade to blade plane), and then eight different geometries are created. The entire 4-stage compressor was simulated in order to monitor the effect of each stage on other stages clearly. The results indicate that increasing the shroud angle increases compressors choke margin while maintaining the surge point constant, which improves the compressors operating envelope. It was also shown that while the hub curve radius does not play an essential role in performance characteristics of compressor, the shroud curve radius can improve the polytropic efficiency and pressure ratio significantly. Finally, it was shown that increment in blades trailing edge angle leads to increment in achieved head coefficient, near surge point operating condition.

### References

- [1] Robinson, C. J., M. V. Casey, and Ian Woods. "An integrated approach to the aero-mechanical optimisation of turbo compressors." *Current Trends in Design and Computation of Turbomachinery*, CKD Nové Energo & TechSoft Engineering, Prague, Czech Republic (2011).
- [2] Robinson, Chris, et al. "Impeller-diffuser interaction in centrifugal compressors." *Proceedings of ASME Turbo Expo. 2012.*
- [3] Borm, Oliver, and Hans-Peter Kau. "Unsteady aerodynamics of a centrifugal compressor stage–validation of two different CFD solvers." *ASME Turbo Expo. 2012.*
- [4] Everitt, Jonathan N., and Zoltán S. Spakovszky. "An Investigation of Stall Inception in Centrifugal Compressor Vaned Diffuser." *Journal of Turbomachinery* 135.1 (2013): 011025.
- [5] Hildebrandt, A. "Aerodynamic optimization of a centrifugal compressor return channel and u-turn with genetic algorithms." *Proceedings of ASME Turbo Expo. 2011.*
- [6] Guidotti, Emanuele, et al. "Cavity flow modeling in an industrial centrifugal compressor stage at design and off-design conditions." *ASME Turbo Expo. 2012.*
- [7] Marechale, Russell, Min Ji, and Michael Cave. "Experimental and Numerical Investigation of Labyrinth Seal Clearance Impact on Centrifugal Impeller Performance." *ASME Turbo Expo 2015: Turbine Technical Conference and Exposition. American Society of Mechanical Engineers, 2015.*
- [8] Guidotti, Emanuele, et al. "Accuracy of centrifugal compressor stages performance prediction by means of high fidelity cfd and validation using advanced aerodynamic probe." *ASME Paper No. GT2013-95618 (2013).*
- [9] Baltadjiev, Nikola D., Claudio Lettieri, and Zoltán S. Spakovszky. "An Investigation of Real Gas Effects in Supercritical CO<sub>2</sub> Centrifugal Compressors." *Journal of Turbomachinery* 137.9 (2015): 091003.
- [10] Gibson, L., et al. "Assessment of turbulence model predictions for a

centrifugal compressor simulation."  
Journal of the Global Power and  
Propulsion Society 1 (2017): 142-156.;  
Global Power and Propulsion Society  
Zurich, 10th-12th January 2018  
switzerland.