

Implementation of electro-optic amplitude modulator in the external cavity of semiconductor laser for generation of periodic states and chaos control

Kh Mabhouli and A Jafari

Department of Physics, Faculty of Sciences, Urmia University, Urmia, Iran

E-mail: a.jafari@urmia.ac.ir

(Received 11 May 2015 ; in final form 12 June 2016)

Abstract

In this paper, by placing the electro optical modulator (EOM) into the external cavity of the semiconductor laser (SL) and amplitude modulation of the optical feedback, the dynamical variation of the output intensity ($|E|^2$) of the laser has been studied. This is analyzed numerically via bifurcation and time series diagrams with respect to the applied amplitude modulation index, and modulation voltage frequency of the EOM. It has been shown that, by modulating the amplitude of the optical feedback beam, various changes in the types of the dynamics of $|E|^2$ can be observed, and various periodic states can be generated. This makes it possible to receive the desired dynamics without any variations in the main parameters of the SL. Also, in present study, a method of chaos control in the SL has been presented based on EOM in the external cavity. The obtained results confirm that based on this method the chaotic dynamics can be controlled single-periodic dynamics.

Keywords: semiconductor laser, electro optical modulator, external cavity, chaos control

1. Introduction

Semiconductor lasers have been considered to be interesting [1,2] mainly due to their potential applications in secure optical communications, coherent light sources for technological optical transition, ultra-fast optical processing, and high speed modulation and detection [3-5]. Semiconductor lasers are very sensitive to one or more external perturbations such as optical feedback [6], electro-optical feedback [7], optical injection from a different laser [8], and current modulation [9]. In application of semiconductor lasers in optical communications and optical parts, optical feedback has always been of a lot of attention. When the external light cannot be fully insulated in all optical communications, due to this small amount of optical feedback, laser can generate various nonlinear dynamics and chaotic intensity fluctuations [10, 11]. These chaotic oscillations have affected the normal efficiency of the laser and the bit-error rate in data transmission. Chaos is an important behavior of dynamical systems that arises in a great variety of physical arenas [12]. One of the remarkable discoveries of the recent decade is related to the pervasive presence of chaos in multi dynamical systems that has led to a new field of research for

controlling chaos. Since “The Ott, Grebogi and Yorke's chaos-control method” was presented [13], chaos-control techniques have rapidly been developed [14, 15]. Chaos-control techniques have successfully been demonstrated to convert a chaotic motion to a periodic regular motion [16] in emerging applications such as encoded communications and the design of high quality optical communication systems [17,18].

Chaos control in the semiconductor lasers has been extensively used in recent years in applications such as optical feedback, optical phase modulation, and negative or positive optical feedback [19], injecting periodic signals and perturbing the current, variation of the pump current [20], and so on [21, 22]. The control process in semiconductor laser can be categorized as follows: continuous control [23], occasional proportional feedback control [24], sinusoidal modulation control [25], and optical control [26].

The sinusoidal modulation control is very easy to apply and the fast modulation is easily attained through the injection current modulation. Therefore, this method is frequently used in semiconductor laser systems. But modulation frequencies derived from the linear stability analysis do not always work for the stabilization, and

also selection of direct modulation may lead to a high intensity noise such as Langevin quantum noise [27].

Injection current modulation is not the only technique to modulate accessible parameters for the implementation of chaos control in semiconductor lasers. As an alternative modulation method for chaos control, we can refer to an extra mirror in the feedback loop to control chaotic oscillations in a semiconductor laser [26], where optical chaos control system uses double external mirrors. One of the mirrors is the external mirror that gives rise to chaotic oscillations in the semiconductor laser and the second mirror is used for the control.

The utilization of electro optic modulator is for controlling the polarization, amplitude, frequency, phase, and so on. In order to modulate light wave, the electro optic effect can be considered as one of these different methods. Electro-optic modulator (EOM) devices are developed to be applied in communications [28-30]. These devices can be employed for optimum performance at a single wavelength, whose performance with wideband and multimode lasers degrades to some extent [31,32].

In this study, the EOM is used to modulate the amplitude of the optical feedback laser beam in the external cavity. One of the principal aims of this work is to insert the EOM to the external cavity, which provides the possibility that, without providing any changes in the main parameters of the SL, various periodic states and chaos suppression can be obtained just by changing the amplitude and frequency of the modulation voltage injected to the EOM. By this method, the reflected amplitude varies in a way that it shifts the laser operation from chaotic to stable and periodic operation.

This study starts with numerical study of the dynamical response of a semiconductor laser (SL) in the presence of the amplitude modulation of the optical feedback beam and finding the regions in which various periodic and chaotic dynamics can be obtained. The dynamical response of the SL is analyzed through bifurcation diagrams versus modulation voltage frequency (ω), and amplitude modulation index (V_m/V_π) as the control parameters. Second, it is shown that the EOM can convert chaotic regimes to periodic ones, and the chaos in the output intensity of the laser can be controlled. This paper is based on above-mentioned theoretical studies, and the results obtained attempt to introduce a novel simple idea of chaos control and generation of various periodic dynamics in semiconductor lasers.

2. Laser model

Semiconductor lasers are employed in optical storage systems, communication systems, as pump sources, for material processing, and in many other applications [33, 34]. In 1980, Lang and Kobayashi (LK) reported on some aspects of the statics and dynamics of the semiconductor laser exposed to the external optical feedback from an external cavity [35], where they used delay differential equations with the advantage that has an infinite-dimensional phase space [36,37]. The LK equations have greatly been employed as models for

description of an SL, subject to an external optical feedback. The description of low-frequency fluctuations [38], fast pulsations [39] and regular pulse packages [10] can be carried out by them. However, the LK equations contain approximations which have to be done willfully as modeling data are being compared with the experimental data. The LK model is the sole factor for the one longitudinal mode of the solitary laser. As the model behavior of the multimode lasers is analyzed, these phenomena can happen being beyond the LK description, anti-phase dynamics [40, 41], for instance. Since multiple reflections are ignored by the LK model, one should take more care when regarding strong feedback. Strongly asymmetric facet reflection may result in some effects, for example jump ups not being captured by the LK model [42]. These limitations are known to us, however, we should pick out the LK model. The reason is that the LK model agrees so much with the experimental results [10,43]. In fact, the LK equations can explain very complicated phenomena in the low feedback domain [44]. The dynamics of the laser can be described by the following dimensionless and compact form of equations [45]:

$$\frac{dE}{dt} = (1 + i\alpha)NE + \eta E(t - \tau)e^{-iC_p}, \quad (1)$$

$$T \frac{dN}{dt} = P - N - (1 + 2N)|E|^2. \quad (2)$$

Equations (1) and (2) describe a semiconductor laser with an external optical feedback. For the complex electric field E and inversion N parameters, α is the line width enhancement factor, C_p is the 2π -periodic feedback phase, P is the pump current and η is the feedback strength. It is found that the output dynamics of the laser is chaotic with a low feedback rate of $\eta = 0.0455$ [46], which corresponds to a feedback-induced reduction of the threshold relative to the solitary laser of $\sim 7\%$. In these equations, time is normalized to the cavity photon lifetime (1ps) and T is the ratio of the carrier lifetime (1ns) to the photon lifetime [10]. The external round trip time (τ) is also normalized to the photon lifetime. In numerical investigation, values for external round trip time are considered $\tau = 70$ and $\tau = 121$. For $\tau = 70$, different parameters are held fixed at $T = 1710$, $P = 0.8$ and $\alpha = 5.0$, and for $\tau = 121$ these values are $T = 550$, $P = 0.136$ and $\alpha = 3.5$ [45]. In many feasible applications, such as fiber couplers, the external cavity is only a few cm long. So a decrease in the lengths of external cavity (L_{ext}) has had main physical subsequences. L_{ext} can be specified by the chosen external cavity round-trip time (τ) whose $\tau = 2L_{ext}/c$ represents the round-trip delay time within the external cavity and c is the velocity of light. The present study has been done on a short external cavity. This has been satisfied by considering $\tau = 70, 121$ for the external cavity in numerical investigation.

3. Control method

Chaotic behavior of the laser will remain unchanged

with fixed C_p , η and P . It means that when the laser operates chaotically, its output will not be changed, unless the above parameters are varied. However, it seems that by applying the EOM and modulating the amplitude of the feed backed laser beam in the external cavity, the instability of the laser output can be controlled.

In addition, in a chaos control process, continuous generation of an error signal method has been implemented for detecting instability and selecting the appropriate values for modulation frequency and amplitude parameters.

This method has been useful in fast systems applications to control a chaotic nonlinear circuit [47], and also was used in our previous study [48]. This method involves the continuous generation of an error signal from the difference between the output intensity ($|E|^2$) signal and its value at an earlier time. In this method, a portion of the laser beam is directed to photodiode (PD) by the beam splitter. This PD is used to convert a sample of laser light to an electric voltage V_{PD} , and this voltage is connected to non-inverting input of the controller which connects a suitable modulating voltage produced by a signal generator to the EOM. Finally, the EOM stabilizes the output of the laser by amplitude modulating of the round trip laser beam in the ring external cavity.

4. Methods of amplitude modulation

The laser beam can be modulated in several methods. The following methods of amplitude modulation have proven to be successful: a dynamic retarder configuration with a crossed polarizer at the output, a dynamic retarder configuration with a parallel polarizer at the output, a phase modulator configuration in a branch of a Mach-Zehnder interferometer, or a dynamic retarder with push-pull electrodes [32]. In this study, "dynamic retarder configuration with a crossed polarizer" is selected as an amplitude modulator. The transmission for this modulator is :

$$T(V) = \frac{I_o}{I_i} = \text{Sin}^2\left(\frac{\Gamma}{2}\right) = \text{Sin}^2\left(\frac{\Gamma_0}{2} + \frac{\pi V}{2V_\pi}\right), \quad (3)$$

where, V is the applied voltage, V_π is the half-wave voltage, and T is the ratio of the output to the input intensity:

$$T = \frac{I_o}{I_i} = \frac{|E_o|^2}{|E_i|^2}. \quad (4)$$

For a sinusoidal modulation voltage $V = V_m \text{Sin } w_m t$, the transmission becomes[32]:

$$T(V) = \text{Sin}^2\left(\frac{\pi}{4} + \frac{\Gamma_m}{2} \text{Sin } w_m t\right), \quad (5)$$

where $\Gamma_m = \pi V_m / V_\pi$ is the amplitude modulation index or depth-of-amplitude modulation. In this paper, for simplifying the ratio between modulation voltage and half-wave voltage, V_m / V_π is assumed as the amplitude

modulation index.

By considering eq. (5), the simple model for controlling the stability of laser can be introduced as below:

$$\begin{cases} \frac{dE}{dt} = (1 + i\alpha)NE + KE(t - \tau)e^{-iC_p}, \\ T \frac{dN}{dT} = P - N - (1 + 2N)|E|^2, \end{cases}$$

$$K = \begin{cases} \text{for unstable operation of the laser :} \\ \eta \left(\text{Sin} \left(\frac{\pi}{4} + \frac{\pi V_m}{2V_\pi} \text{Sin}(w_m t) \right) \right), \\ \text{for stable operation of the laser :} \\ \eta. \end{cases} \quad (6)$$

According to this model, the amount of optical feedback strength is variable referring to the laser operation condition. For the unstable operation of the laser, the value of the optical feedback strength is $\eta \left(\text{Sin} \left(\frac{\pi}{4} + \frac{\pi V_m}{2V_\pi} \text{Sin}(w_m t) \right) \right)$ and for the stable operation, it is η . The controlling optical setup is shown in figure 1.

In this figure, the external cavity contains two different optical paths: Path (I), for stable operation of SL and Path (II), for the unstable operation of SL. When SL operates in a stable way with periodic dynamics, the laser beam is fed back by an external mirror in the simple cavity with a constant value of $K = \eta = 0.0455$. In this case, coupled eqs. (1) and (2) describe a semiconductor laser dynamics with an external optical feedback in the simple cavity. Furthermore, when SL operates in an unstable way and chaotically, the laser is fed back from unidirectional ring external cavity with the feedback strength $K = 0.0455 \left(\text{Sin} \left(\frac{\pi}{4} + \frac{\pi V_m}{2V_\pi} \text{Sin}(w_m t) \right) \right)$.

Then, K can be introduced to the eqs. (1) and (2). In this case, coupled eq. (6) describes a semiconductor laser dynamics with an external optical feedback in unidirectional ring cavity. Unidirectional ring external cavity containing the rotating mirror (RM), and the EOM is controlled by electrical controller.

In this configuration, RM is being used to switch the laser from simple external cavity to ring external cavity, and the EOM is used for amplitude modulating of the laser and generating variable feedback strength. The proposed electrical controller is depicted in figure 2.

This figure contains PD, micro controller, signal generator, step motor and the EOM, respectively. PD converts a sample of laser light to the electrical voltage V_{PD} which is connected to the micro controller. One of the tasks of the micro controller in the control process is monitoring the V_{PD} variations. In fact, the amount of V_{PD} can be changed with respect to the dynamics types of output intensity of SL. The amplitude of laser output in the chaotic operation is greater than its output in periodic operation. This is shown obviously in figure 3. So, the amount of converted voltage for the chaotic dynamics is greater than the amount of converted voltage for the periodic dynamics. The voltage that is

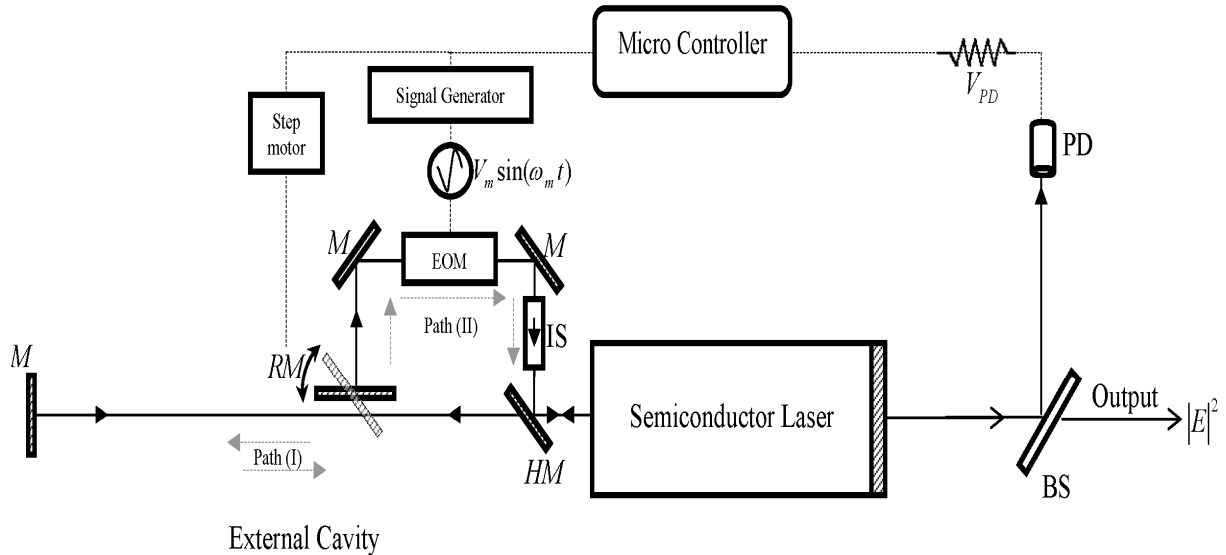

Figure 1. Schematic diagram of semiconductor laser with electro-Optic amplitude modulator in external cavity and electrical controller (BS: beam splitter; PD: photodiode; M: mirror; HM: half mirror; RM: rotating mirror; EOM: electro-optic modulator; IS: isolator; Path (I): simple external cavity; Path (II): unidirectional ring external cavity containing EOM).

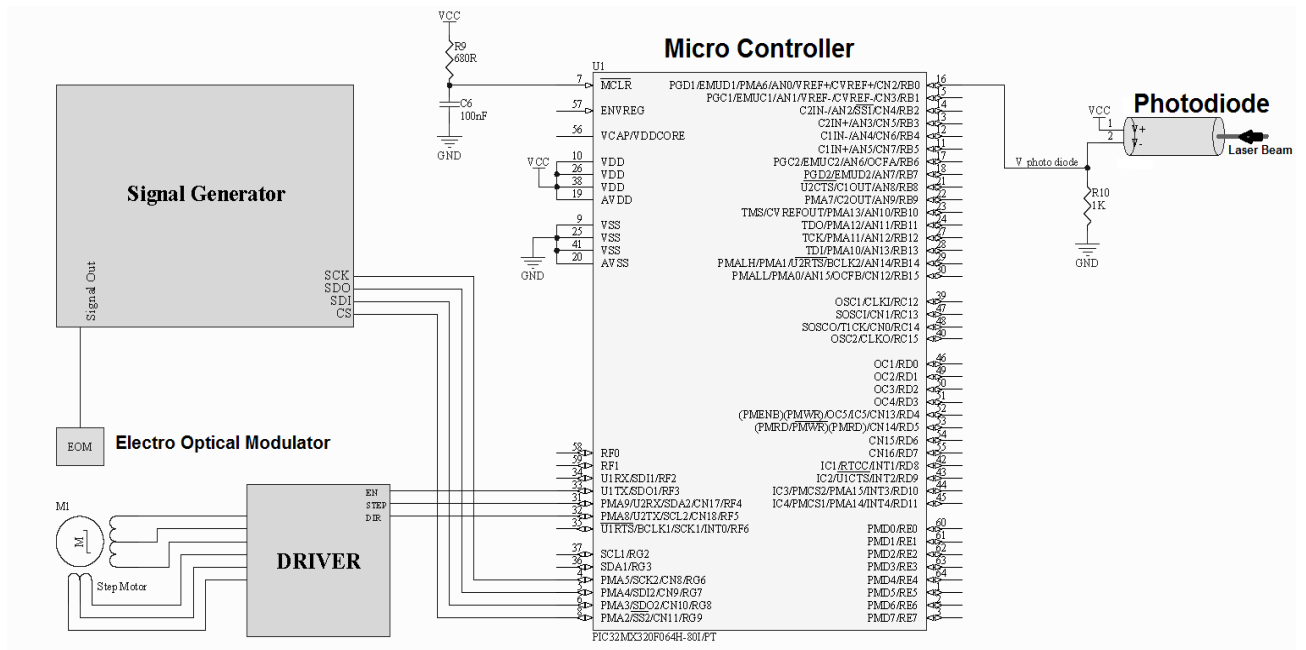

Figure 2. Laser stability controller circuit.

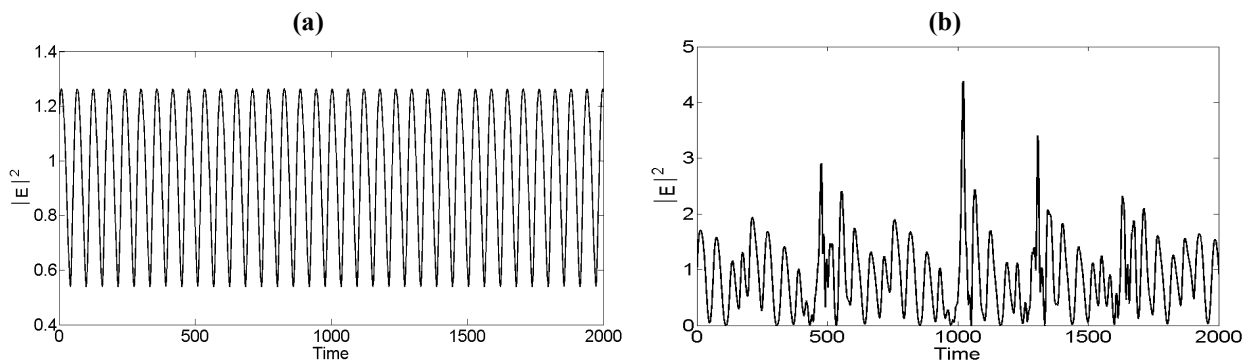

Figure 3. Numerically plotted time series showing a sample of oscillations in the output intensity, $|E|^2$, of the laser when subject to simple external optical feedback: (a) periodic (period-1) and stable oscillations state, (b) chaotic and unstable oscillations state.

proportional to the unstable dynamics is named as V_C , and when it is upper than this voltage, the laser will operate chaotically.

Therefore, for PD voltage values lower than V_C , the laser will operate in a stable way with a periodic dynamics. Now, consider the situation in which PD continuously converts a sample of laser light to electric voltage V_{PD} and the micro controller checks the values of V_{PD} . If the laser operates chaotically, the laser intensity increases, and the voltage V_{PD} becomes more than V_C . In this case, the micro controller simultaneously switches the external cavity from Path (I) to Path (II) and connects the signal generator to the EOM. In this process, for switching the optical path between these two types of external cavity, the micro controller rotates the RM to the desired direction by means of step motor. In the chaos operation of the laser, the values of K changes continuously by micro controller. This is done by increasing the frequency w_m or the amplitude V_m of the modulation voltage of the signal generator, $V = V_m \text{Sin } w_m t$. By making the V_{PD} voltages vary, this variation of K continues until the voltage of V_{PD} becomes less than V_C . In fact, when a suitable value of K is generated by the EOM (for stabilizing the operation of the laser), the possibility of continuous operation will be supplied by means of the final desired amounts of K . Later on, if the amplitude of the output of the laser decreases more, and V_{PD} becomes less than the normal condition in which the laser can operate, $V_{PD} < V_{\min}$, the micro controller switches Path(II) to Path(I) with constant values of optical feedback $K (\eta = 0.0455)$, by rotating RM. V_{\min} is proportional to the minimum value of the amplitude of laser output which is converted by PD and is introduced to the micro controller as a smaller value in which the laser can operate. In that case, the system changes to its initial condition.

For studying the output intensity dynamics of the semiconductor laser using control method mentioned earlier, feedback phase and feedback strengths are selected as control parameters. Meanwhile, to generate a set of periodic and quasi-periodic (QP) dynamics and dynamical diversity in the output of laser, we have selected the values for modulation frequency, in the range of MHz, which is smaller than laser operation frequency (GHz). This is due to higher frequency values for modulation voltage, in the range of GHz, that can increase the operation frequency of the laser so that to restrict the dynamical diversity in the output of laser.

5. Effect of EOM on the output dynamics of $|E|^2$

There are many parameters to characterize instabilities and chaos in semiconductor lasers. Every parameter is important for describing the characteristics. However, one important and the most useful parameter to figure out the characteristics is the reflectivity of the external

mirror. Tkach and Chraplyvy [49] investigated the instabilities of semiconductor lasers with optical feedback and categorized them into the following five regimes, depending on the feedback fraction.

The gain in the presence of optical feedback depends on the round-trip time τ and it changes periodically for the variation of external cavity length. The mode for the maximum gain is attained at $C_p = \omega_0 \tau = 2m\pi$ (m being an integer and ω_0 is relaxation oscillation frequency of the laser). As the gain varies, depending on the optical feedback level, we can control or suppress the adjacent modes from the main oscillation mode when the external mirror is positioned close to the laser facet [7]. Before applying the control method mentioned above, the dynamical behavior of $|E|^2$ as a function of time variations, which the laser operates chaotically in, is shown in figure 3b. In fact, we have used the chaotic dynamics as samples to be subjected to the EOM to show the method efficiency in suppressing chaos.

In this section, in order to study the role of the EOM on the output dynamics of SL, we have analyzed the dynamics of $|E|^2$ as a function of amplitude modulation index, V_m/V_π , and modulation frequency, w_m , in the ranges of the $0 < V_m/V_\pi < 5$ and $0 < w_m < 1$ GHz as the control parameters. Different values of w_m and V_m/V_π in these intervals are selected so that the output of the laser reaches a stable state.

5.1 Effect of modulation frequency variations on $|E|^2$

At first, in order to study the dynamical response of SL to modulation frequency variations, the numerical calculated bifurcation diagrams of $|E|^2$ versus w_m are plotted in the range of 0 to 1 GHz.

In figure 4a, the output dynamics of SL, $|E|^2$, has been depicted as a function of w_m for $V_m/V_\pi = 1$. For the small values of w_m , $|E|^2$ operates in the chaotic dynamics ($w_m < 0.092$). Further increasing of w_m leads to the appearance of small periodic oscillation regions at $0.094 < w_m < 0.14$ and $0.186 < w_m < 0.22$. Finally, $|E|^2$ dynamics undergoes a small periodic regime followed by a large domain of QP, which begins at $w_m = 0.3$. Figure 4b shows the dynamics of $|E|^2$ as a function of w_m , for $V_m/V_\pi = 1$. In this case, for some small values of w_m the dynamics of $|E|^2$ shows an instability and chaotic dynamics. At $w_m > 0.080$, areas of the periodic dynamics appear, which lead to the columns of chaotic dynamics. It should be noted that as

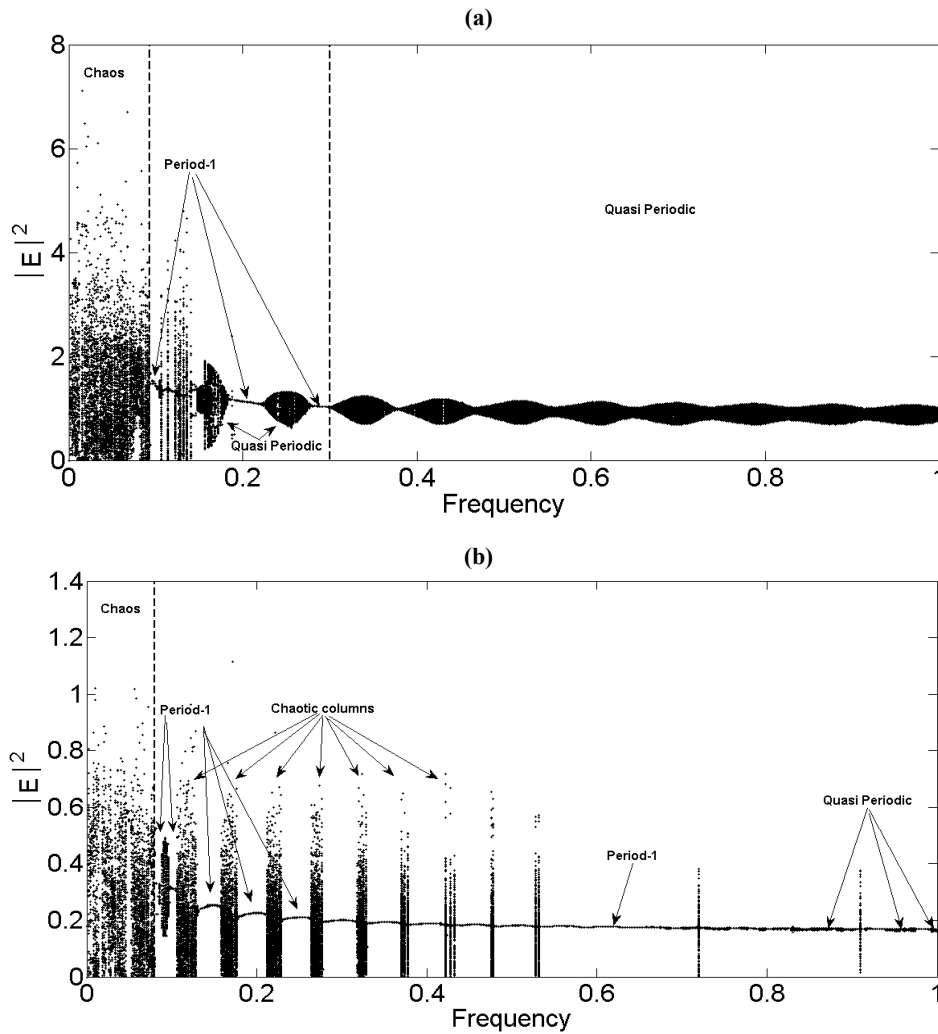

Figure 4. Numerical bifurcation diagrams of dynamical response of output intensity, $|E|^2$, versus modulation frequency w_m (GHz) variations with amplitude modulation $V_m/V_\pi = 1$ and $K = 0.0455(\sin(\frac{\pi}{4} + \frac{\pi V_m}{2V_\pi} \sin(w_m t)))$. (a) $\tau = 70$ and $C_p = \pi$. (b) $\tau = 1.21$ and $C_p = 0$.

w_m is increased, the domain of P1 dynamics becomes wider and wider, while the area of chaotic dynamics becomes narrower. However, at high frequencies, QP dynamics appears instead of P1 dynamics.

5.2 Effect of amplitude modulation index variations on $|E|^2$

In this section, we have analyzed the dynamics of $|E|^2$, as a function of V_m/V_π , as a control parameter. These studies are based on a fixed value for modulation frequency, w_m , of the EOM ($w = 0.1\text{GHz}$). In figure 5a, the output dynamics of SL, $|E|^2$, has been depicted as a function of V_m/V_π for $w = 0.1\text{GHz}$. As it can be seen from this figure, for some small values of V_m/V_π , the laser shows P1 dynamics (at $V_m/V_\pi < 0.38$). By increasing the amplitude modulation index, the dynamics of $|E|^2$ undergoes a domain of chaotic dynamics. In the

range of $0.910 < V_m/V_\pi < 0.992$, the dynamics of $|E|^2$ shows the inverse period doubling and in the range of $0.996 < V_m/V_\pi < 1.03$, shows the P1. Further increasing of V_m/V_π leads to the appearance of a large chaotic oscillation region. This chaos region ends abruptly and a small region of a small QP region with 3, 4 and 5 branches appears at $V_m/V_\pi = 4.154$. Finally, at $V_m/V_\pi = 4.828$, this QP region leads to a new domain of chaotic dynamics. At last, in figure 5b, the dynamics of $|E|^2$ has been demonstrated as a function of V_m/V_π , for $w = 0.1\text{GHz}$. In this figure, for small values of w_m , $|E|^2$ operates in the periodic dynamics (P1). Further increasing of V_m/V_π leads to the appearance of small chaotic oscillation regions (at $0.414 < V_m/V_\pi < 0.662$). At $V_m/V_\pi = 0.664$, this chaos region disappears and the small QP region with five branches appears. Then, this QP region leads to a new P1 dynamics. By increasing

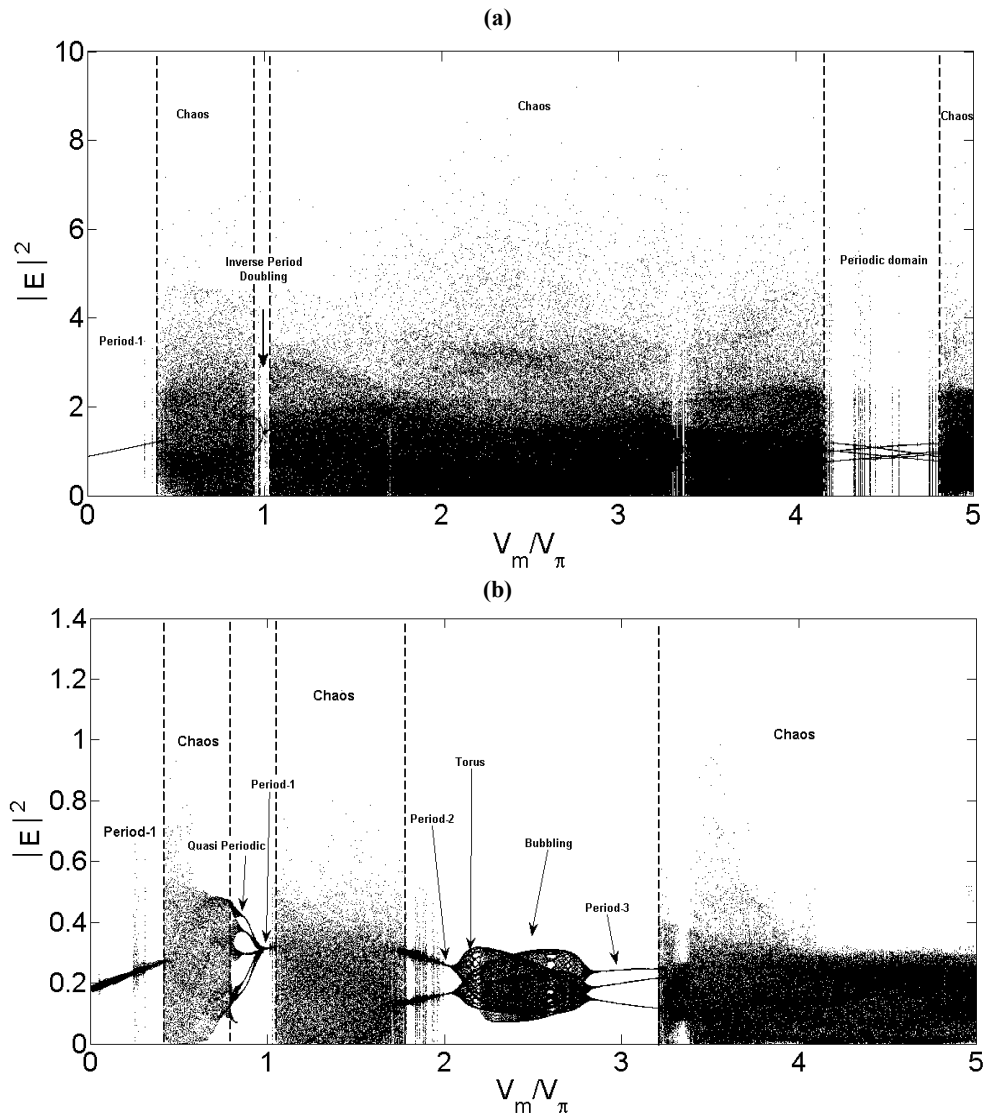

Figure 5. Numerical bifurcation diagrams of dynamical response of the output intensity, $|E|^2$, versus the variations of amplitude modulation V_m/V_π with modulation frequency $w_m = 0.1$ (GHz) and $K = 0.0455(\sin(\frac{\pi}{4} + \frac{\pi V_m}{2V_\pi} \sin(w_m t)))$. (a) $\tau = 70$ and $C_p = \pi$. (b) $\tau = 121$ and $C_p = 0$.

V_m/V_π , in the range of $1.05 < V_m/V_\pi < 1.782$, the dynamics of $|E|^2$ shows chaotic dynamics again. At the meantime, increasing of V_m/V_π leads to the appearance of a P2 dynamics (at $1.788 < V_m/V_\pi < 2.038$), two torus bifurcation (at $2.040 < V_m/V_\pi < 2.204$), three quasi period bubblings (at $2.208 < V_m/V_\pi < 2.858$), and P3 dynamics (at $2.860 < V_m/V_\pi < 3.208$), respectively. Finally, at the range of $3.21 < V_m/V_\pi < 5$ a large domain of the chaos appears. It should be noted that the torus bifurcation contains an area where there are branches of QP dynamics, and in which this area becomes wider as the amplitude modulation index is increased. To validate the above results, the time series of $|E|^2$ for the values of V_m/V_π and w_m mentioned in figure 5 have been investigated. The sample of chaotic oscillations in the

output intensity, $|E|^2$, in terms of time for the case of before applying the control method, is represented in figure 3b. And for the case of after applying the control method, the time series of $|E|^2$ with $\tau = 70$ is depicted in figures 6a and 6b for $(V_m/V_\pi = 1, w = 0.5\text{GHz})$ and $(V_m/V_\pi = 0.2, w = 0.1\text{GHz})$, respectively. The time series of $|E|^2$ in figure 6a indicates a QP dynamics, and in figure 6b indicates a P1 dynamics. As a result, for the appropriate values of the amplitude modulation index, V_m/V_π , and the modulation frequency, w_m , the stable dynamics (P1) can be achieved. and also, for the case of $\tau = 121$, the dynamics of $|E|^2$, in terms of time after applying the proposed technique, are represented in figures 7a-f. The time series appearing in figure 7a represents a stable dynamics (P1) for $(V_m/V_\pi = 0.001$,

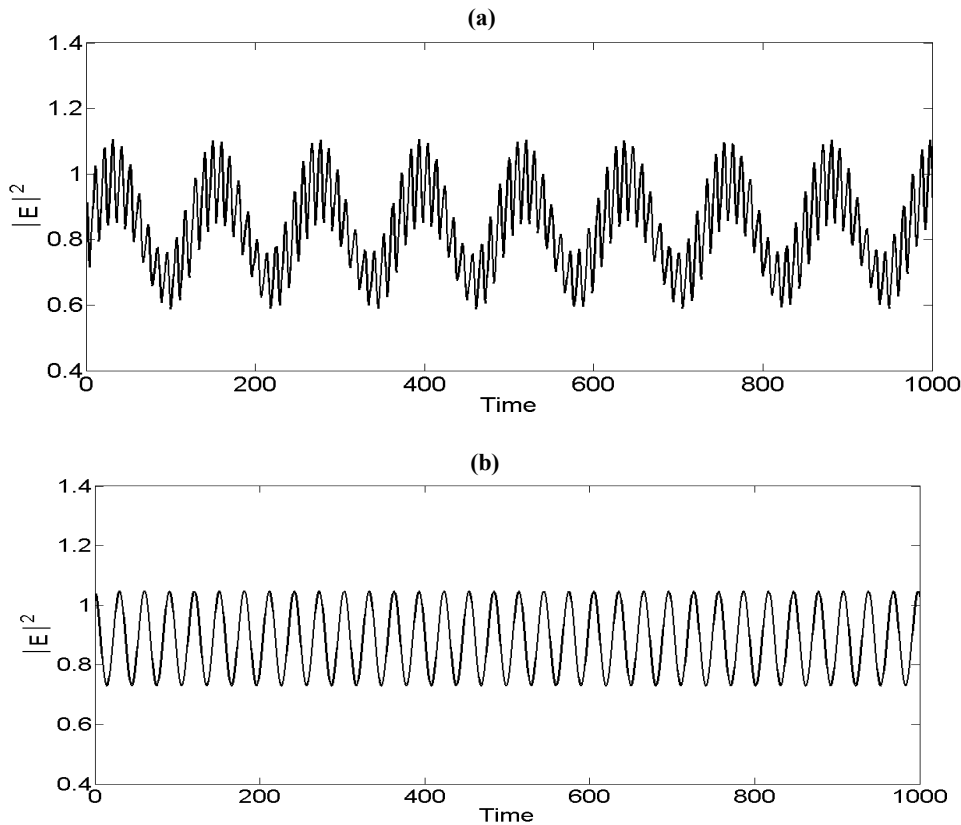

Figure 6. Numerically calculated time series of dynamical response of output intensity, $|E|^2$, after applying the proposed technique with: $\tau = 70$ and $C_p = \pi$. (a) Quasi periodic dynamics for $V_m/V_\pi = 1$ and $w = 0.5$ GHz. (b) Period one dynamics for $V_m/V_\pi = 0.2$ and $w = 0.1$ GHz.

$w = 0.1$ GHz). Figure 7b also shows a P1 dynamics for ($V_m/V_\pi = 1$, $w = 0.1$ GHz), but, due to an increase in V_m/V_π , initial delays in receiving the stable dynamics are removed. Further increasing of V_m/V_π leads to the appearance of different periodic and chaotic dynamic. It can be seen that the dynamics of $|E|^2$ in terms of time, with $w = 0.1$ GHz, for $V_m/V_\pi = 2$ is P2 (Figure 7c), for $V_m/V_\pi = 3$ is P3 (Figure 7d), and for $V_m/V_\pi = 4$ is chaotic (Figure 7e). Meanwhile, increasing the w_m from 0.1 to 1 GHz leads to the appearance of a QP dynamics (Figure 7f).

6. Effect of applying the control method on $|E|^2$, under the variation of C_p

In this section, for studying the output intensity dynamics of $|E|^2$, under applying the control method (Figure 1), the dynamics of $|E|^2$ has been investigated under the variation of C_p as control parameters. Before applying the control method, the dynamical behavior of $|E|^2$ as a function of C_p is shown in figure 8a for $\tau = 70$ and figure 9a for $\tau = 121$, respectively [48].

After applying the EOM effects in the external cavity, the dynamics of $|E|^2$, as a function of C_p , is shown in figures 8b and 9b. In figures 8b and 9b, K varies by the control method. In these cases, K becomes $0.0455 (= \eta)$ for the stable areas (periodic behaviors), while, for the chaotic areas of $|E|^2$, as a function of C_p , it changes to $K = 0.0455 \left(\sin\left(\frac{\pi}{4} + \frac{\pi V_m}{2V_\pi} \sin(w_m t)\right) \right)$ by control method. This process is performed by eq. (6). Moreover, in this control process, to have a better performance, different values of V_m/V_π have been used: $V_m/V_\pi = 0.2$ for $\tau = 70$, and also $V_m/V_\pi = 1, 0.9$ and 0.8 for $\tau = 121$. For simplicity, w_m is assumed to be constant $w_m = 0.1$ for both values of $\tau = 70$ and $\tau = 121$, as well.

Figure 8a shows that as the phase is decreased, the laser undergoes a Hopf bifurcation to a limit cycle. Then, the dynamics of $|E|^2$ undergoes torus. At $C_p \approx -2.356$, the dynamics on the torus bifurcation becomes locked to a stable periodic orbit, which shows up as seven branches. The bifurcating periodic orbit makes seven loops around the torus, leading to seven branches. Finally, at $C_p = -2.498$, the periodic solution undergoes

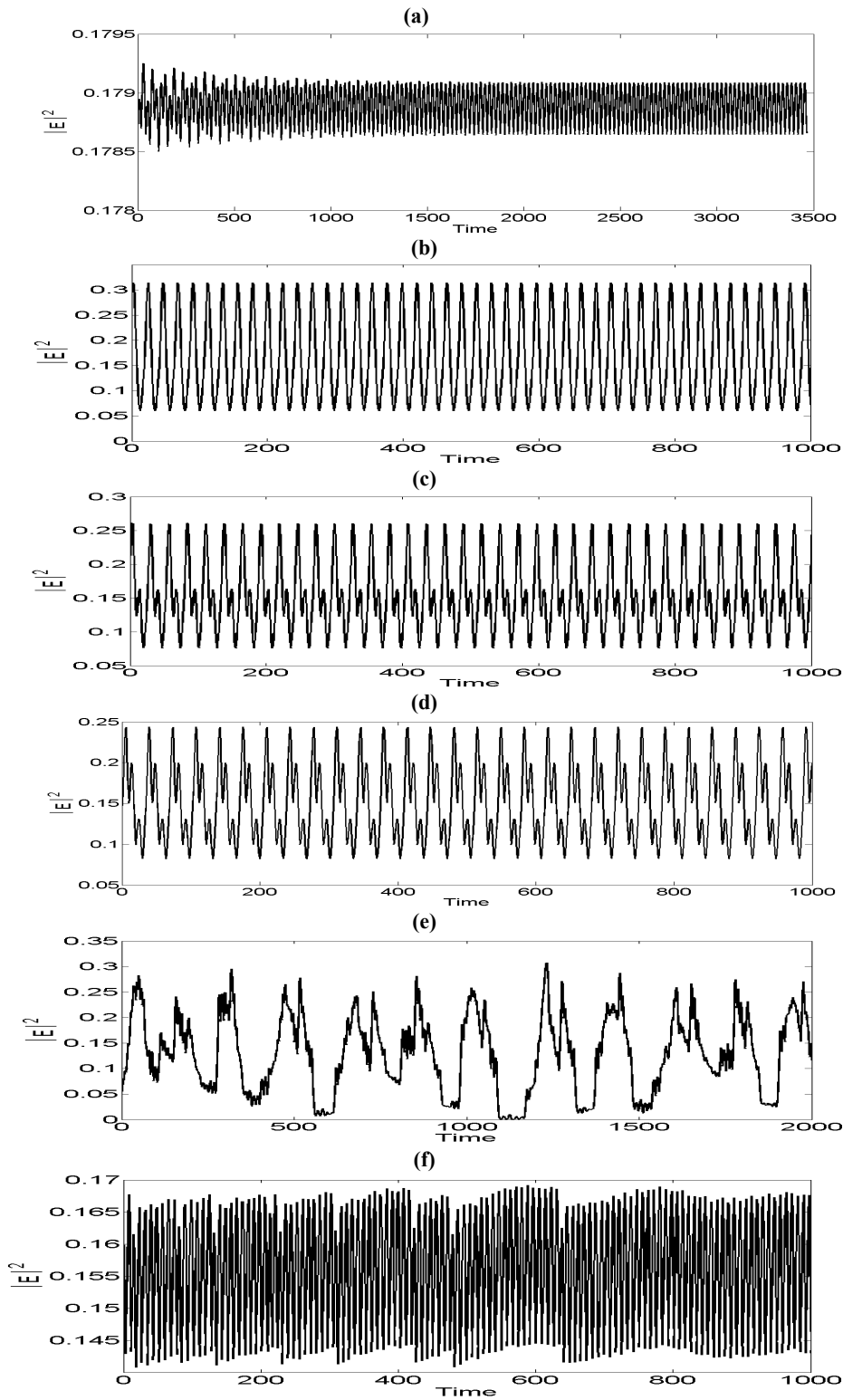

Figure 7. Numerically calculated time series of dynamical response of output intensity, $|E|^2$, after applying the proposed technique with laser parameters: $\tau=121$ and $C_p=0$. (a) Period one dynamics for $V_m/V_\pi=0.001$, $w=0.1$ (GHz). (b) Period one dynamics without initial delays in receiving the stable dynamics, for $V_m/V_\pi=1$, $w=0.1$ GHz. (c) Period-2 dynamics for $V_m/V_\pi=2$, $w=0.1$ GHz. (d) Period-3 dynamics for $V_m/V_\pi=3$, $w=0.1$ GHz. (e) Chaotic dynamics for $V_m/V_\pi=4$, $w=0.1$ GHz. (f) Quasi periodic dynamics for $V_m/V_\pi=1$, $w=1$ GHz.

[DOI: 10.18869/acadpub.ijpr.16.3.63]

Downloaded from ijpr.iut.ac.ir at 9:53 IRDT on Sunday May 14th 2017

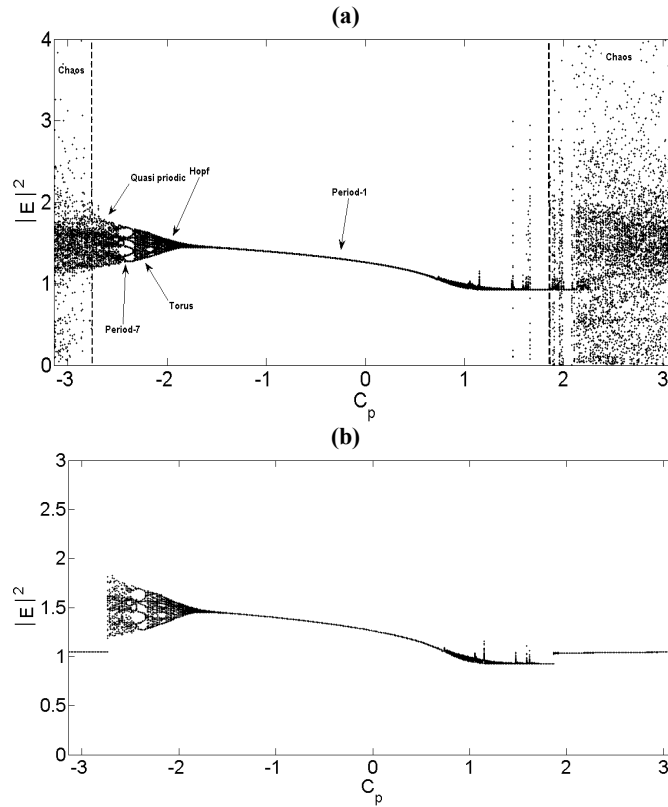

Figure 8. Bifurcation diagrams of the output intensity, $|E|^2$, versus the feedback phase variation ($\tau = 70$, $\eta = 0.0455$ and $P = 0.8$). (a) Before applying control method, (b) after applying control method with $V_m/V_\pi = 0.2$ and $w = 0.1\text{GHz}$.

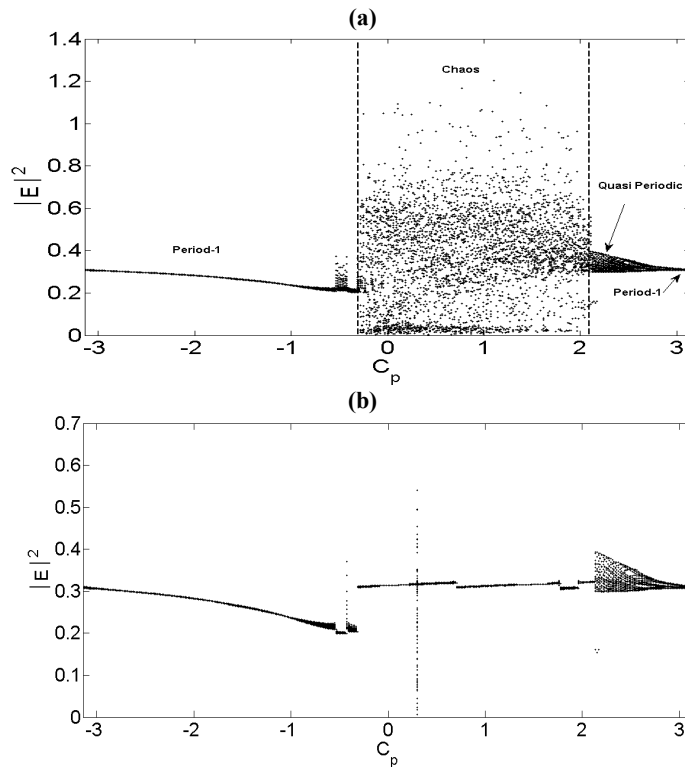

Figure 9. Bifurcation diagrams of the output intensity, $|E|^2$, versus the feedback phase variation ($\tau = 121$, $\eta = 0.0455$ and $P = 0.136$). (a) Before applying control method, (b) after applying control method with $V_m/V_\pi = (1, 0.9, 0.8)$, and $w = 0.1\text{GHz}$.

a small QP region, leading to a new domain of the chaotic dynamics [41]. By applying the control method

with $V_m/V_\pi = 0.2$ and $w = 0.1\text{GHz}$, as it can be seen from figure 8b, the chaotic area in the output of the laser

Downloaded from ijpr.iut.ac.ir at 9:53 IRDT on Sunday May 14th 2017 [DOI: 10.18869/acadpub.ijpr.16.3.63]

is completely removed and a P1 dynamics appears instead of the chaotic one.

In continuation, to study the efficiency of the control method further, the dynamical behavior of $|E|^2$ for the greater value of τ ($\tau = 121$), before applying the control method, as a function of C_p , is shown in figure 9a. As it can be seen, for some negative values of C_p , $|E|^2$ operates in the periodic dynamics (P1). As the feedback phase is increased, the periodic dynamics undergoes a chaotic domain ($-0.314 < C_p < 2.105$), leading to QP and P1 regions, respectively. In this case, because of increasing the time delay in the external cavity to $\tau = 121$, the previous value of $V_m/V_\pi = 0.2$ (used in Figure 5) does not have a suitable effect in reducing the instability. Therefore, to have a better performance, different values are chosen for the amplitude modulation index ($V_m/V_\pi = 1, 0.9$ and 0.8). Hence, in figure 9b, applying the control method with $\omega = 0.1$ GHz and $V_m/V_\pi = 1$ (for $-0.314 < C_p < 0.691$ and $1.950 < C_p < 2.105$), $V_m/V_\pi = 0.9$ (for $0.692 < C_p < 1.75$) and $V_m/V_\pi = 0.9$ (for $1.76 < C_p < 1.94$) leads to converting the chaotic dynamics to P1 dynamics.

7. Conclusion

In this study, an electro optical method to the chaos control and the generation of various periodic states in the semiconductor laser has been presented based on modulating the amplitude of optical feedback beam in the external cavity. On the basis of this method, the following results can be summarized:

Modulating the amplitude causes various changes in the types of the dynamics of $|E|^2$. The EOM can remove the instability and chaos of output dynamics of the laser. These instabilities can completely be removed on the condition that we expect the laser operates chaotically. Our investigation indicates that the value of the amplitude modulation, ratio between modulation voltage V_m and half-wave voltage V_π , and the modulation voltage frequency ω_m play an important role in the process of chaos suppression in the external cavity semiconductor laser.

In other words, only for the specific values of the modulation and amplitude, stable dynamics can replace instable dynamics. On the other hand, when it is possible to control the instability in the specific domain of the modulation amplitude, the ratio between V_m and V_π becomes so important. It means that when the

modulation voltage is so small ($V_m \ll V_\pi$), a time delay in chaos control can be observed, and by increasing the value of V_m in comparison with the value of V_π , this time delay is removed.

In the chaos control process, the results show that chaos can be suppressed and controlled, which can effectively control the system to a one-cycle state or multi-cycle states. For high values of frequencies, laser operates in the quasi periodic dynamics, and in lower values of frequencies, it operates in the periodic dynamics.

Adding the EOM to the external cavity of the semiconductor laser can provide this possibility that without providing any change in (τ, C_p, η, P) parameters, various periodic states can be generated and the desirable dynamics can only be obtained by causing a change in the amplitude and frequency modulation ($V = V_m \sin \omega_m t$).

By using the EOM and applying it in the electro optical controlling setup, we have been able to design a controlling setup that analyzes and controls the output dynamics of the laser. In this process, K , according to eq. (6), can choose different values, in the stable operation it can choose a fixed value and in the instable operation it can choose a different value ($K = \eta (\sin(\frac{\pi}{4} + \frac{\pi V_m}{2V_\pi} \sin(\omega_m t)))$). It will be more

desirable if the obtained results of this study is used in comparison with using the chaotic map generator circuit [48] in the control process.

The difference between the method implemented in this paper and the other ones is in causing the least noise in laser operation. As a case in point, in the studies done in the past, we can refer to laser control with direct modulation by the delayed optoelectronic feedback [50]. The thing that should be considered in those papers is inconsideration of the effect of the current variation pumped on the stimulated emission rate and therefore it again causes another noise in the laser. And also, we can refer to the study implemented on the basis of optical chaos control [51]. In this study, by changing the feedback strength value, laser can be controlled better. But it should be taken into consideration that by adding permanent optical device in the external cavity, laser is shifted from its initial normal operation conditions. So, we have applied two different optical paths for normal operation conditions and chaotic operation. Moreover, in this paper, control parameter can simply and rapidly be changed by an electrical circuit.

References

1. B Liu, Y Braiman, N Nair, Y Lu, Y Guo, P Colet, and M Wardlaw, *Opt. Commun.* **324** (2014) 301.
2. P Bhattacharyya, *Opt. Commun.* **319** (2014) 188.
3. W Jia-Gui, X Guang-Qiong, C Liang-Ping, and W Zheng-Mao, *Opt. Commun.* **282** (2009) 3153.
4. S Banerjee, L Rondoni, S Mukhopadhyay, and A P

- Misra, *Opt. Commun.* **284** (2011) 2278.
5. S Banerjee, L Rondoni, and S Mukhopadhyay, *Opt. Commun.* **284** (2011) 4623.
 6. J Mørk, B Tromborg, and J Mark, *IEEE J. Quant Electron.* **28** (1992) 93.
 7. J. Ohtsubo, "Semiconductor Lasers Stability, Instability and Chaos", 3rd ed., Springer Verlag, Berlin, chapter 7 (2013).
 8. S Wieczorek, B Krauskopf, and D Lenstra, *Opt. Commun.* **172** (1999) 279.
 9. J Sacher, D Baums, P Panknin, W Elsässer, and E O Göbel, *Phys. Rev. A* **45** (1992) 1893.
 10. T Heil, I Fisher, and W Elsäßer, *Phys. Rev. Lett.* **87** (2001) .
 11. R Vicente, J Daudén, P Colet, and R Toral, *IEEE Quantum Electron.* **41** (2005) 541.
 12. J P Eckmann, and D Ruelle, *Rev. Mod. Phys.* **55** (1985) 617.
 13. E Ott, C Grebogi, and J A York, *Phys. Rev. Lett.* **64** (1990) 1196.
 14. K Su and C Li, *Optik* **125** (2014) 3693.
 15. C Han and S Yu, *Optik* **125** (2014) 3491.
 16. A Uchida, *Phys. Rev. E* **58** (1998) 7249.
 17. L Wu and S Q Zhu, *Chin. Phys.* **12** (2003) 300.
 18. S L Yan, *Chin. Optics Lett.* **3** (2005) 283.
 19. S L Yan, *Comm. Theor. Phys.* **47** (2007) 491.
 20. S Rajesh and V M Nandakumaran, *Physica D* **213** (2006) 113.
 21. A Ahlborn and U Parlitz, *Phys. Rev. Lett.* **96** (2006).
 22. G Jiang, J Zhang, Y Fu, and W Wang, *Optik* **123** (2012) 2140.
 23. A Naumenko, N Loiko, S Turovets, P Spencer, and K Shore, *J. Opt. Soc. Am. B* **15** (1998) 551.
 24. S Turovets, J Dellunde, and K Shore, *J. Opt. Soc. Am. B* **14** (1997) 200-208.
 25. F Ruiz-Oliveras and A Pisarchik, *Opt. Express* **14** (2006) 128596.
 26. A Uchida, T Sato, T Ogawa, F Kannari, *IEEE J. Quantum Electron.* **35** (1999) 1371.
 27. M Ahmed and A Bakry, *Opt. Commun.* **360** (2016) 52.
 28. A Nabih and Z Rashed, *Opt. Commun.* **294** (2013) 49.
 29. D Samanta and S Mukhopadhyay, *Optik* **121** (2010) 1129.
 30. J A Ibarra Fuste and M C Santos Blanco, *Opt. Laser Technol.* **49** (2013) 296.
 31. A Yariv and P Yeh, "Optical Waves in Crystals", Wiley, New York (1984).
 32. M Bass, C MacDonald, G Li, C M DeCusatis, and V N Mahajan, "Handbook Of Optics", 3rd ed., The McGraw Hill, New York , Vol. 5, chapter 7 (2010).
 33. G P Agrawal, "Fiber-Optic Communication Systems", 4nd ed., Wiley, New York (2010).
 34. F Bachmann, P Loosen, and R Poprawe, "High Power Diode Lasers: Technology and Applications", Springer, New York (2010).
 35. R Lang and K Kobayashi, *IEEE Quantum Electron.* **16** (1980) 347.
 36. T Erneux, *Phys. Rev. E* **69** (2004) 036210.
 37. Yu Kuznetsov, "Elements of Applied Bifurcation Theory", Springer, Berlin (2005).
 38. T Heil, I Fischer, W Elsäßer, J Mulet, and C R Mirasso, *Opt. Lett.* **24** (1999) 1275.
 39. D W Sukow, T Heil, I Fischer, A Gavrielides, A H AbiChedid, and W Elsäßer, *Phys. Rev. A* **60** (1999) 667.
 40. G Vaschenko, M Guidici, J J Rocca, C S Menoni, J R Tredecce, and S Balle, *Phys. Rev. Lett.* **81** (1998) 5536.
 41. A Uchida, Y Liu, I Fischer, P Davis, and T Aida, *Phys. Rev. A* **64** (2001) 023801.
 42. M. Pan, B. Shi, and G.R. Gray, *Opt. Lett.* **22** (1997) 166.
 43. T Heil, I Fischer, W Elsäßer, B Krauskopf, K Green, and A Gavrielides, *Phys. Rev. E* **67**, (2003) 0662141.
 44. D M Kane, K A Shore, "Unlocking Dynamical Diversity: Optical Feedback Effects on Semiconductor Lasers", Wiley, Chichester (2005).
 45. K. Green, *Phys. Rev. E* **79** (2009) 036210.
 46. A Jafari, H Sedghi, Kh Mabhouti, and S. Behnia, *Opt. Commun.* **284** (2011) 3018.
 47. D J Gauthier, D W Sukow, H M Concannon, and E S Socolar, *Phys. Rev. E* **50** (1994) 2343.
 48. A Jafari, Kh Mabhouti, S Afrang, and A Siahcheshm, *Opt. Laser Technol.* **44** (2012) 1398.
 49. R Tkach and A Chraplyvy, *J. Lightwave Technol.* **4** (1986) 1655.
 50. S Rajesh and V M Nandakumaran, *Physica D* **213** (2006) 113.
 51. G Jiang, J Zhang, Y Fu, and W Wang, *Optik* **123** (2012) 2140.