

Mathematical Models of Drying Pomegranate Arils in Vacuum and Microwave Dryers

S. Minaei¹, A. Motevali^{2*}, E. Ahmadi³, and M. H. Azizi³

ABSTRACT

Drying behavior of two types of pomegranates as well as the effect of drying conditions on moisture loss trend and on effective diffusion coefficient of arils are discussed in this article. Also, an appropriate mathematical drying model as well as the activation energy of sweet and sour pomegranate arils, dried in vacuum and microwave dryers are pursued and presented. Results of regression analysis of the studied models indicated that Midilli and Page models exhibit the best fit to the data obtained for vacuum and microwave drying, respectively. Effective diffusion coefficient of pomegranate arils was estimated in the ranges of 0.74×10^{-10} to $52.5 \times 10^{-10} \text{ m}^2 \text{ s}^{-1}$ and 3.43×10^{-10} to $32.05 \times 10^{-10} \text{ m}^2 \text{ s}^{-1}$ for vacuum and microwave dryers, respectively. Activation energy figures for the vacuum drier were 52.27 and 52.83 kJ while for microwave drier they were 17.22 and 23.83 kJ for the cases of sweet and sour variety pomegranates, respectively.

Keywords: Drying model, Microwave drier, Pomegranate aril, Vacuum drier.

INTRODUCTION

Pomegranate (*Malus Granatum*) belongs to *Punicaceae* family (Shahrestani, 1998). Overall, the fruit can be divided into sour and sweet types. Its origin is Near East, especially Iran, such that its sour kind is found in large populations in the forests of northern Iran. It is produced in Spain and in the Southern coastal countries of the Mediterranean Sea (Shahrestani, 1998).

Drying is one of the oldest preservation methods for such fruits as pomegranate. Drying of food materials depends on the heat and mass transfer characteristics of the product being dried. Knowledge of the temperature and moisture distributions throughout the product is vital for equipment as well as process design, quality control, and choice of appropriate storage and

handling practices. Mathematical models that describe drying mechanisms of foodstuff can provide the required temperature and moisture information for proper control of the process (Rafiee *et al.*, 2009).

The most common dryers employed in drying of fruits are fan-assisted convection dryers. These kinds of dryers can suffer from some such undesirable effects as surface burning, shrinkage and discoloration. Also, long time taking drying periods along with high energy consumption are other disadvantages associated with hot air dryers. Their modification or use of other types of dryers utilizing other different drying systems can probably overcome some of the mentioned problems. Use of vacuum in a drier is an alternative for product quality improvement. Also, a reduction of pressure,

¹ Department of Agricultural Machinery Engineering, College of Agriculture, Tarbiat Modares University, Tehran, Islamic Republic of Iran.

² Department of Engineering, Shahre Rey Branch, Islamic Azad University, Tehran, Islamic Republic of Iran.

* Corresponding author, e-mail: ali.motevali62@yahoo.com

³ Department of Food Science and Technology, College of Agriculture, Tarbiat Modares University, Tehran, Islamic Republic of Iran.



namely an application of vacuum can reduce the required drying temperature, leading to an improvement in the product quality (Jaya and Das, 2003; Kompany, *et al.*, 1993). Vacuum drying is a unit operation employed in chemical and engineering processes, in which moisture bearing material is dried under sub-atmospheric pressures. The lower pressure allows the drying temperature to be lowered while higher quality product being obtained as compared with the conventional process which occurs at atmospheric pressure (Fernando and Thangavel, 1987; Jaya and Das, 2003).

Lee and Kim (2009) investigated the vacuum drying kinetics of Asian white radish slices. They determined the effect of drying temperature and of sample thickness on characteristics of white radish slices. Arevalo and Fernando-Pinedo (2007) investigated the drying kinetics of pumpkin at pressure and temperature levels of 5-25 Pa, and 50-70°C, respectively.

Microwave drying of foodstuff is a relatively inexpensive method, having attracted the attention of many researchers in recent years. Microwaves are electromagnetic waves within the range of 300 MHz to 300 GHz. Electromagnetic energy can be absorbed by water-containing materials and converted to heat. Dipole rotation can explain the mechanism of heat generation in microwave-exposed foods. Foodstuffs contain such polar molecules as water. These molecules exhibit random orientations, such that when placed in an electric field they tend to orient themselves with the field's polarity. In a microwave field, polarity changes occur at a rapid sequence (Schiffman, 1992).

Karaaslan and Tuncer (2008) used microwave, convection, and microwave-convection driers for drying of spinach leaves and investigated the effects on the drying period, rate of drying and as well on color changes. Ilknur (2007) used microwave, convection and microwave-convection driers for drying of pumpkin slices and determined the optimum drying time, final product color, as well as energy

consumption. The objective of developing drying models for agricultural products is to predict the drying trend (Gogus and Maskan, 1999). Numerous studies have been conducted on application of microwaves in seed drying (Adu and Otten, 1996; Walde *et al.*, 2002), drying of vegetables (Litvin *et al.*, 1998; Lin *et al.*, 1998; Alibas, 2006), and fruit drying (Tulasidas *et al.*, 1997; Funebo and Ohlsson, 1998) operations.

Selection of a standard model plays an important role on the goodness of fit of the model in describing the drying of a product. Therefore, a knowledge of such physical and thermal characteristics of agricultural products as mass and heat transfer as well as the effective moisture diffusivity coefficients is important and indispensable. The objectives followed in this study are as follows:

- 1). An investigation of the drying behavior of sour and sweet pomegranate arils.
- 2). Determining the best mathematical model that can describe the kinetics of the drying process.
- 3). Assessing the effect of different drying conditions on the rate of moisture loss.
- 4). Determining the effect of drying conditions on the effective diffusivity coefficient.
- 5). Calculation of the value of activation energy in sour and sweet pomegranate arils dried in either of the vacuum or microwave driers.

MATERIALS AND METHODS

Material Preparation and Drying Conditions

The fresh sour pomegranates for the study were obtained from Juybar city of Mazandaran Province while the sweet ones obtained from Neyriz in Fars Province. The fruits were kept in a refrigerator at 5°C before commencement of the tests. The initial moisture content of the fruits was determined through oven drying. Twenty-gram samples were placed in the oven at

105±1°C for about four hours until no significant difference observed between two successive weighings (Aghbashlo *et al.*, 2008). The tests were all replicated 5 times. Initial moisture contents of 333% and 342.2% (dry basis) were found for the sour, and sweet pomegranates, respectively.

The Experimental Facilities

Pomegranate arils were dried by means of each of vacuum (VS-1202 V5, Korea, ±1°C) and microwave driers (SAMSUNG, 75DK300036V, model: M945, Korea). A diaphragm type vacuum pump (Serno: 26431801, Germany, ±1 kPa) was employed for creating the necessary vacuum. In vacuum drying method, drying was performed at five temperature levels of: 50, 60, 70, 80, 90°C, and 250 kPa of vacuum. Air parameters were adjusted through an assessment of temperature, pressure and humidity. A thermometer (Lutron, TM-925, Taiwan, ±0.1°C), and a pressure gauge (PVR 0606A81, Italy, ±0.1 kPa) were respectively made use of to measure air temperature and pressure in the vacuum chamber while a humidity meter (Testo 650, 05366501, Germany, ±0.1%) being employed to determine measure the relative humidity. Ambient temperature was found out to be 20-26°C while the relative air humidity varied within the range of 22-27%. As schematic view of a microwave drier is illustrated in Figure 1.

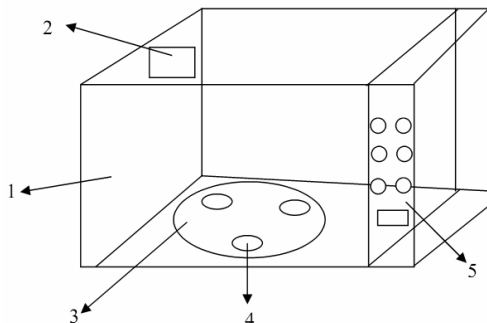

Figure 1. Microwave dryer: 1- Chamber; 2- Microwave radiation site; 3- Circular plate; 4- Sample, 5- Power adjustment.

In the microwave drying method, three power levels of: 100, 200, and 300W were employed to dry the samples. Samples in the case of vacuum drier were weighed within 30 minutes intervals and once every 60 minutes towards the end of the process while using a 0.0001 g accuracy balance (Sartorius, TE214S, AG Germany). In the microwave drying method, weighing was conducted at 5 minutes intervals. During the weighing process of the samples, the vacuum generation was brought to a halt in vacuum drying system and restored after every weight measurement being made with the process taking about 40 seconds. Weighing of samples was continued until no change was observed between two successive weighings.

Theoretical Principles

Moisture ratio for pomegranate arils was found out using the following equation:

$$MR = \frac{M_t - M_e}{M_o - M_e} \quad (1)$$

where MR is moisture ratio (dimensionless), M_t moisture content at any given time (kg water kg⁻¹ solids), M_e standing for equilibrium moisture content (kg water kg⁻¹ solids) and M_o representing the initial moisture content. As M_e is too far lower than either M_o or M_t , it is neglected (Diamante and Munro, 1991), then,

$$MR = \frac{M_t}{M_o} \quad (2)$$

Drying curves were fitted with ten different moisture ratio models (Table1). These models are generally derived by simplifying the general series solutions of Fick's second law and considering a direct relationship between the average water content and drying time (Doymaz, 2004).

Three different criteria considered for an evaluation of best fit: correlation coefficient, R^2 ; chi square, χ^2 ; and Root Mean Square Error, $RMSE$ (Aghbashlo *et al.*, 2007; Hossain and Bala, 2002).



Table 1. Models employed for fitting of experimental data.

Number	Model	Model reference name	Reference
(1)	$MR = \exp(-kt)$	Newton	(Lewis, 1921)
(2)	$MR = a \exp(-kt)$	Henderson and Pabis	(Henderson and Pabis, 1961)
(3)	$MR = \exp(-kt^n)$	Page	(Page, 1949)
(4)	$MR = a \exp(-kt) + c$	Logarithmic	(Yagcioglu et al., 1999)
(5)	$MR = a \exp(k_0 t) + b \exp(k_1 t)$	Two term	(Henderson, 1974)
(6)	$MR = a \exp(-kt) + (1-a) \exp(-kbt)$	Approximation of diffusion	(Yaldiz et al., 2001)
(7)	$MR = a \exp(-kt) + (1-a) \exp(-kat)$	Two-term exponential	(Sharaf-Eldeen et al., 1980)
(8)	$MR = a \exp(-kt^n) + bt$	Midili	(Menges and Ertekin, 2005)
(9)	$MR = a \exp(-kt) + (1-a) \exp(-gt)$	Verma et al	(Verma et al., 1985)
(10)	$MR = \exp(-(kt)^n)$	Modified Page	(Wang et al., 2007)
(11)	$MR = 1 + at + bt^2$	Wang and Singh	(Chen and Wu, 2001)

$$R^2 = \frac{\sum_{i=1}^N (MR_{exp,i} - \overline{MR}_{exp})(MR_{pre,i} - \overline{MR}_{pre})}{\sqrt{\sum_{i=1}^N (MR_{exp,i} - \overline{MR}_{exp})^2 \sum_{i=1}^N (MR_{pre,i} - \overline{MR}_{pre})^2}} \quad (3)$$

$$\chi^2 = \frac{\sum_{i=1}^N (MR_{exp,i} - MR_{pre,i})^2}{N - m} \quad (4)$$

$$RMSE = \left(\frac{1}{N} \sum_{i=1}^N (MR_{pre,i} - MR_{exp,i})^2 \right)^{\frac{1}{2}} \quad (5)$$

$MR_{exp,i}$ is the i th moisture ratio relative humidity value determined experimentally, $MR_{pre,i}$ is the i th predicted moisture ratio value, N the number of observations and m the number of drying constants. The most suitable model for describing drying characteristics of pomegranate arils is a model with the highest R^2 and the lowest χ^2 as well as $RMSE$ values. The R^2 , χ^2 and $RMSE$ values stand between 0 and 1.

Drying Rate

Drying rate of pomegranate arils was assessed using the following equation (Akpınar et al., 2003)

$$\text{Drying Rate} = \frac{M_{t+dt} - M_t}{dt} \quad (6)$$

where M_{t+dt} is moisture content at time $t+dt$ (kg water kg^{-1} of dry matter), M_t stands for moisture content at time t (kg water kg^{-1} dry matter) and t representing the drying time (min).

A graduated cylinder containing a specified volume of liquid was used to measure aril volume. The average geometrical diameters of sweet and sour pomegranate arils were separately found out through a determination of the volume of 50 arils using toluene-displacement method (the test was replicated 3 times). The volume of each aril was figured out by dividing the volume of the displaced fluid by the number of arils. The radius of a pomegranate aril was calculated using the following equation (Mohsenin, 1986):

$$v = \frac{4}{3} \pi r_0^3 \quad (7)$$

where v , volume of each aril (m^3), r_0 , radius of pomegranate aril (m). The radiuses of the sweet and sour pomegranate arils were determined to be 4.93 and 4.11 mm, respectively.

Fick's second law for unstable conditions for spherical shapes used by Crank (1975) as follows can describe moisture transfer

during the declining stage of the drying process.

$$MR = \frac{M_t - M_e}{M_o - M_e} = \frac{6}{\pi^2} \sum_{n=1}^{\infty} \frac{1}{n^2} \exp\left(-n^2 \pi^2 \frac{D_{eff} t}{r_o^2}\right) \quad (8)$$

Here MR is moisture ratio (dimensionless), M_t the moisture content at any time, M_e stands for equilibrium moisture content (kg water kg^{-1} solids), M_o is the initial moisture content, n the number of terms considered in the equation, t is the drying time (min), D_{eff} represents the effective diffusion coefficient ($\text{m}^2 \text{s}^{-1}$) and finally r_o is the sphere radius (m) which has been assumed constant during the drying process. For the cases of long drying periods the mentioned equation may be written as:

$$MR = \frac{6}{\pi^2} \exp\left(-\pi^2 \frac{D_{eff} t}{r_o^2}\right) \quad (9)$$

Equation 9 is used for a determination of effective diffusion coefficient (Pahlavanzadeh *et al.*, 2001; Doymaz, 2005; Babalis and Belessiotis, 2004; Aghabashloo *et al.*, 2008). In this process the aril radius is assumed as constant. Equation (9) can be written in the following form:

$$\ln(MR) = \ln\left(\frac{6}{\pi^2}\right) - \left(\pi^2 \frac{D_{eff} t}{r_o^2}\right) \quad (10)$$

Plotting the natural logarithm of data versus time would result in a line with slope k_1 . D_{eff} can then be calculated as:

$$k_1 = \frac{\pi^2 D_{eff}}{r_o^2} \quad (11)$$

Activation Energy in Vacuum Oven

Activation energy can be calculated using Arrhenius equation as follows:

$$D_{eff} = D_o \exp\left(-\frac{E_a}{R_g T_{abs}}\right) \quad (12)$$

where E_a is activation energy, R_g the universal gas constant ($8.3143 \text{ kJ mol}^{-1}$), T_{abs} stands for drier temperature (in Kelvins) and D_o is a constant, read as the ordinate. Taking

the natural logarithm in Equation (12) would lead to:

$$\ln D_{eff} = \ln D_o - \frac{E_a}{R_g} \cdot \frac{1}{T_{abs}} \quad (13)$$

Plotting $\ln(D_{eff})$ versus $(1/T_{abs})$ yields a straight line with a slope of k_2 . The coefficient k_2 can be calculated as follows:

$$k_2 = \frac{E_a}{R_g} \quad (14)$$

Activation Energy in Microwave Oven

Inasmuch as temperature is not precisely measurable inside the microwave drier, the activation energy is found as modified from the revised Arrhenius equation. In a first method it is assumed as related to drying kinetic constant rate (k) and the ratio of microwave output power to sample weight (m/p) instead of to air temperature. Then Equation (15) can be effectively used (Dadali *et al.*, 2007; ozbek and dadali, 2007) as follows:

$$K = K_o \exp\left(\frac{-E_a \cdot m}{p}\right) \quad (15)$$

where K is the constant rate of drying calculated from Page equation (min^{-1}), K_o is pre-exponential constant (min^{-1}), E_a is activation energy (W g^{-1}), P stands for microwave output power (W) and finally m for sample weight (g). As for a second method, the correlation between effective diffusion coefficient and (m/p) is taken into account for the calculation of activation energy (ozbek and dadali, 2007).

$$D_{eff} = D_o \exp\left(-\frac{E_a \cdot m}{p}\right) \quad (16)$$

where P is the microwave output power (W), m the weight of raw sample (g), D_{eff} is the effective moisture diffusivity ($\text{m}^2 \text{s}^{-1}$), D_o standing for pre-exponential constant ($\text{m}^2 \text{s}^{-1}$) and E_a representing the activation energy (W g^{-1}). E_a can be found out by means of curves, Dadali model and multiple regression analysis through *MATLAB* software. This may be accomplished using one of several methods as follows.



$$\ln(D_{eff}) = \ln(D_0) - \frac{E_a}{p} \cdot \frac{m}{1} \quad (17)$$

Following plotting of $\ln D_{eff}$ versus $(1/P)$, K_2 is calculated for the microwave as follows:

$$K_2 = \frac{E_a}{p} \quad (18)$$

RESULTS AND DISCUSSION

Drying times versus temperature in constant vacuum and for sour and as well for sweet pomegranate arils are presented in Figure 2. At 50°C it is the sweet pomegranate that takes a much longer time to dry than the sour variety. A sharp decrease in drying time in both varieties is observed as temperature is increased from 50 to 60°C. Further increase in temperature results in a much more gradual decrease in drying time with the two curves closely approaching each other. This kind of behavior has been reported for vegetables as well (Lee and Kim, 2009; Valo-Pinedo and Xidieh Murr, 2007).

The curves plotting drying time versus microwave power, for sour and sweet pomegranates, are depicted in Figure 3. The

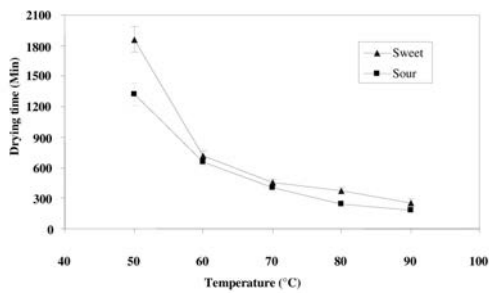

Figure 2. Drying time versus vacuum drying temperature.

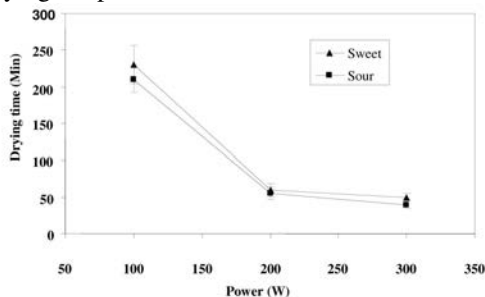

Figure 3. Effect of microwave power on pomegranate aril drying time.

two curves exhibit quite similar behaviors. Drying times at 200 and 300W of applied power are not much different, whilst the time is almost 4.5 times as much when the power is at 100W. This behavior has been reported by Ozbek and Dadali (2007). Microwave drying assists in removing moisture from food products any the problem of case hardening and it helps to reduce the drying time (Prabhanjan et al., 1995). Microwave power applications higher than 300W were tested, however, due to burning of samples, further testing was discontinued.

Moisture diffusion and drying rate phenomena are dependent upon temperature and on product composition (Rizvi, 1986). Since the initial constituents and moisture content of sweet and sour pomegranate arils differ, moisture diffusion and drying time of the two differ as well.

Figure 4(a-b) show the drying trends in sour and sweet pomegranates in the vacuum drier along with the predicted lines as described by Midili model. Aril moisture content sharply decreased with increasing temperature. In

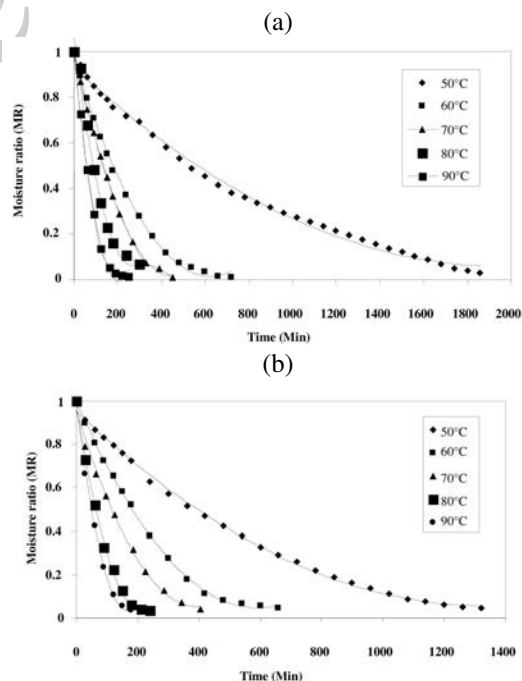

Figure 4. Moisture Ratio data for sweet (a) and sour (b) pomegranate arils at various temperatures in the vacuum drier along with the curves predicted by the Page model.

other words, at higher temperatures, higher levels of heat and mass transfer occur, resulting in a faster trend of drying (Lee and Kim, 2009; Valo-Pinedo and Xidieh Murr, 2007). This trend has been reported in convection drying for many such fruits and vegetables as apricot (Togrul and Pehlivan, 2003), eggplant (Ertekin and Yaldiz, 2004; Wu *et al.*, 2007), olive cake (Akgun and Doymaz, 2005), apple pomace (Wang *et al.*, 2007), pumpkin slices (Doymaz, 2007), as well as for onion slices (Jain and Pathare, 2004; Kumar *et al.*, 2006; Sarsavadia *et al.*, 1999; Sharma *et al.*, 2005).

Regarding the mentioned curves, drying rate or the rate of moisture loss decreases during drying, similar to the results obtained for hot air drying of other products.

Drying trend of pomegranates in microwave drier as well as the predicted curves described through the Page model are presented in Figure 5 (a-b). It can be noted that moisture ratio has decreased rapidly with increase microwave power (Drouzas and Schubert, 1996; Funebo and Ohlsson, 1998; Prabhanjan

et al., 1995; Soysal, 2004). Increased microwave power results in a rapid decline in moisture ratio. Drier oven chamber temperature along with the intensity of microwaves increase with increase in microwave power and as a result, moisture is more intensively lost at higher power rates (Gowen *et al.*, 2008; Alibas Ozkan *et al.*, 2007).

As observed from Figure 5 (a-b) and, similar to the results obtained from hot air drying, drying rate decreases with progress in drying time. Drying time of sweet pomegranate arils in the 100W treatment case was 4.6 times that at 300W, while for sour pomegranates the drying time at 100W of energy was about 5.25 times that at 300W.

At the initial stages of drying, the initial moisture content of the fruit is high and therefore the drying rate is also high, but it decreases as the drying progresses. The product loses a major part of its water during the first stages of drying and it takes longer for the remaining moisture to be dissipated. Multiple regression analysis was performed using MATLAB software. The most suitable model for describing the drying kinetics of pomegranate arils was selected as based on the highest R^2 and the lowest X^2 and $RMSE$ values. A comparison of R^2 , X^2 as well as $RMSE$ values (Table 2) revealed that Midili and Page models were the most fitting models in vacuum and microwave drying for a prediction of the thin layer drying trend of pomegranate arils.

Figure 5 (a-b) reflect the relationship between the Page model constants and hot air temperature of the vacuum drier chamber, for sour and sweet pomegranates, respectively. The equations and corresponding R^2 , X^2 , as well as $RMSE$ values are presented below the tables.

Relationships between page model constants and microwave output power are given in Table 3 for sour and sweet pomegranates, respectively. Also Relationships between page model constants and microwave output power are given in Table 4 for sour and sweet pomegranates respectively.

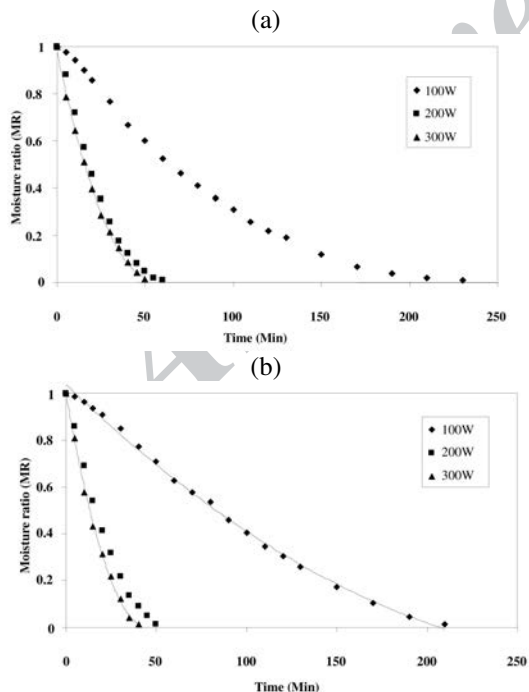

Figure 5. Moisture ratio data for sweet (a) and sour (b) pomegranate arils at various operating powers in the microwave drier along with the curves predicted by the Midili model.



Table 2. Statistical data obtained from various thin-layer drying models in vacuum dryer sweet, sour pomegranate and microwave dryer sweet, sour pomegranate.

Model Number	R^2	RMSE	X^2
vacuum dryer sweet pomegranate			
1	0.9816	0.0458	0.00323
2	0.9844	0.0424	0.00270
3	0.9958	0.0229	0.00122
4	0.9863	0.0411	0.00242
5	0.9844	0.0486	0.00267
6	0.9811	0.0479	0.00308
7	0.9810	0.0471	0.00328
8	0.9992	0.0283	0.00171
9	0.9974	0.0357	0.00317
10	0.9962	0.0285	0.00326
11	0.9752	0.0532	0.00573
vacuum dryer sour pomegranate			
1	0.9912	0.0299	0.00106
2	0.9860	0.0298	0.00093
3	0.9973	0.0202	0.00039
4	0.9928	0.0296	0.00091
5	0.9919	0.0353	0.00085
6	0.9925	0.0302	0.00094
7	0.9918	0.0318	0.00107
8	0.9984	0.0160	0.00078
9	0.9917	0.0261	0.00123
10	0.9890	0.0259	0.00228
11	0.80168	0.0461	0.00339
microwave dryer sweet			
1	0.9689	0.0572	0.00031
2	0.9773	0.0517	0.00050
3	0.9962	0.0186	0.00007
4	0.9773	0.0517	0.00050
5	0.9773	0.0575	0.00050
6	0.9821	0.0473	0.00032
7	0.9811	0.0411	0.00030
8	0.9968	0.0147	0.00014
9	0.9838	0.0443	0.00060
10	0.9932	0.0265	0.00028
11	0.97931	0.0568	0.00053
microwave dryer sour			
1	0.9800	0.0467	0.0060
2	0.9858	0.0406	0.0041
3	0.9979	0.0157	0.0008
4	0.9858	0.0406	0.0041
5	0.9860	0.0430	0.0040
6	0.9842	0.0498	0.0052
7	0.9799	0.0481	0.0060
8	0.9979	0.0152	0.0012
9	0.9878	0.0373	0.0046
10	0.9892	0.0398	0.0048
11	0.9659	0.0763	0.0067

Table 3. Relationship between the Page model constants and hot air temperature in the vacuum drier sour and sweet pomegranate arils.

vacuum drier sour pomegranate	
$k = e^{-(0.078T)}$	$R^2 = 0.91$ (19)
$n = 0.016T$	$R^2 = 0.97$ (20)
$MR(T) = \exp(-e^{-(0.078T)} \times t^{(0.016T)})$	(21)
$R^2 = 0.8924$	RMSE = 0.0749
	$\chi^2 = 0.00217$
vacuum drier sweet pomegranate	
$k = e^{-(0.088T)}$	$R^2 = 0.95$ (22)
$n = 0.01752T$	$R^2 = 0.99$ (23)
$MR(T) = \exp(-e^{-(0.088T)} \times t^{(0.01752T)})$	(24)
$R^2 = 0.9183$	RMSE = 0.0571
	$\chi^2 = 0.00162$

Table 4. Relationship between the Page model constants and microwave operating power for sour and sweet pomegranate arils.

sour pomegranate	
$K = 0.0000762P$	$R^2 = 0.94$ (25)
$n = 0.0057P$	$R^2 = 0.81$ (26)
$MR(P) = \exp((-0.0000762P) \times t^{(0.0057P)})$	(27)
$R^2 = 0.8681$	RMSE = 0.0913
	$\chi^2 = 0.00463$
sweet pomegranate	
$K = 0.0000843P$	$R^2 = 0.94$ (28)
$n = 0.005424$	$R^2 = 0.83$ (29)
$MR(P) = \exp((-0.0000843P) \times t^{(0.00542P)})$	(30)
$R^2 = 0.8891$	RMSE = 0.0725
	$\chi^2 = 0.00295$

Drying Rate

During the early stages, drying rate increases rapidly, reaching a maximum value, then starts to decrease with progress in drying time. A similar trend has been reported by many such researchers as Ertekin and Yaldiz (2004); Wang *et al.* (2007); Celma, *et al.* (2007); Babalis and Belessiotis (2004), Kaya *et al.* (2007).

Drying curves in Figure 6 (a-b) show higher drying rates occurring at higher temperatures.

Drying curves shown in Figure 7 (a-b) follow the general expected pattern, however, drying rate in the microwave drier is somewhat more irregular than that in the vacuum drier. As can be observed, drying rate increases with increasing microwave power. The highest drying rate is obtained at 300W, similar for both types of pomegranates. Therefore, microwave operational power has an important effect on drying rate (Alibas Ozkan *et al.*, 2007; Gowen *et al.*, 2008; Karaaslan and Tuncer,

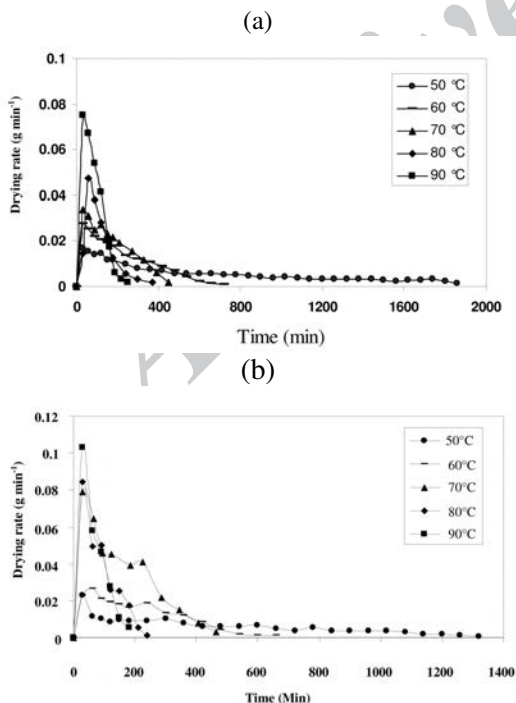

Figure 6. Drying rate curves for sweet (a) sour (b) pomegranate arils in vacuum drier

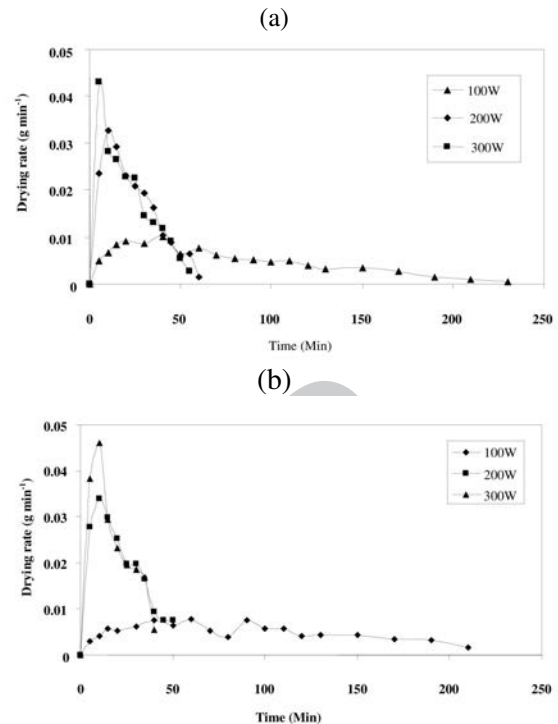

Figure 7. Drying rate curves for sweet (a) and sour (b) pomegranate arils in microwave drier.

2008; Cheng *et al.*, 2006).

Drying was continued until no difference was observed between successive weighings. Moisture Ratio was calculated using Equation (1). Figure 8 (a-b) show plots of $\ln(MR)$ versus time in vacuum drying at various temperatures for sour and sweet pomegranates, respectively. Value of D_{eff} is calculated from Equation (7) and is reported for sweet and sour pomegranates in

Table 5. The lowest moisture diffusion value for sweet pomegranate arils in vacuum drying and at 50°C was found to be 0.74×10^{-10} the highest diffusion of moisture for sour pomegranate arils at 90°C was estimated as 5.25×10^{-10} . In microwave drying and at a 100W rate of power, the lowest moisture diffusion value was obtained for sour samples as 3.43×10^{-10} whilst the highest value obtained for the sweet sample namely 3.05×10^{-10} . These observations are in match with those found drying pumpkins (1.13×10^{-9}



Table 5. D_{eff} estimation and statistical analysis using the linear model at various temperatures in the vacuum drier for sweet and sour pomegranate.

Variables	sweet pomegranate					sour pomegranate				
Temperature	50	60	70	80	90	50	60	70	80	90
$D_{eff} \times 10^{-10} (\text{m}^2 \text{s}^{-1})$	0.74	2.4651	4.9302	4.9302	7.3953	6.77	13.5	16.9	50.08	50.08
R^2	0.94	0.98	0.95	0.97	0.99	0.98	0.98	0.99	0.98	0.99

to $5.70 \times 10^{-9} \text{m}^2 \text{s}^{-1}$), as reported by Valo-Pinedo and Xidieh Murr (2007) and in drying radish slices (6.92×10^{-9} to $14.59 \times 10^{-9} \text{m}^2 \text{s}^{-1}$) as reported by Lee and Kim (2009).

According to Rizvi (1986) moisture diffusion is dependent upon temperature and the product's structural composition. Considering the proportional to similarity of drying temperature in vacuum drier and the operational power of microwave drier, it can be concluded that the only factor affecting the moisture diffusion difference between the two varieties of pomegranate is their structural composition. Figure 8(a-b) imply that, in the vacuum drier, as temperature

increases, slopes of the lines increase indicating that moisture diffusion increases with temperature. Also from Figure 9(a-b) it can be concluded that by increasing microwave power, the slope of the lines increases. In other words, moisture diffusion increases with microwave power. Effective diffusion coefficient data for sweet and sour pomegranates dried in vacuum and microwave driers are presented in Tables 5 and 6.

Activation Energy in Vacuum Drier

Activation energy is calculated from the slope of the curve $\ln(D_{eff})$ curve versus $(1/T)$ (Figure 10). The activation energy of sweet

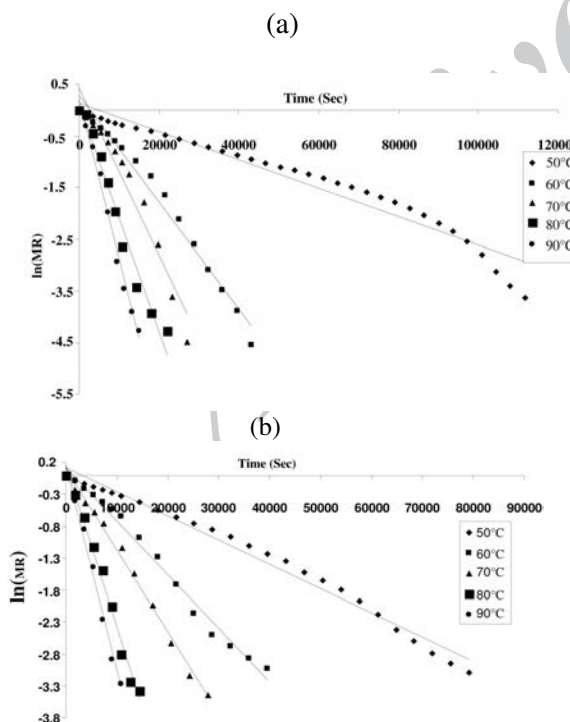

Figure 8. Plot of $\ln(\text{MR})$ versus time (s) for a) sweet and b) sour pomegranate arils in vacuum dryer.

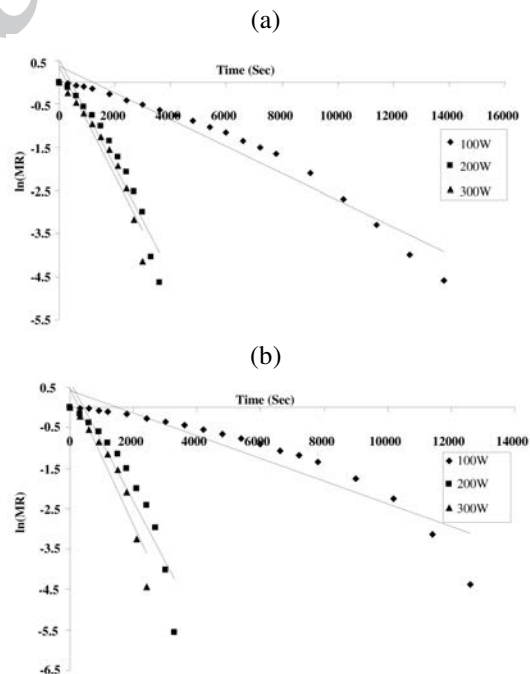

Figure 9. $\ln(\text{MR})$ versus time (s) for a) sweet and b) sour pomegranate arils in microwave dryer.

Table 6. D_{eff} estimation and statistical analysis using the linear model at various temperatures in the microwave drier for sweet and sour pomegranate.

Variables	sweet pomegranate			sour pomegranate		
Power (W)	100	200	300	100	200	300
$D_{eff} \times 10^{-10} (\text{m}^2 \text{s}^{-1})$	7.29	29.58	32.05	3.43	25.76	29.19
R^2	0.95	0.93	0.93	0.91	0.89	0.90

and sour pomegranate arils in vacuum drying method was found out as 52.275 and 52.859 (kJ mol^{-1}) respectively (Table 7), which are also acceptable for such agricultural products as okra 51.26 kJ mol^{-1} , (Gogus and Maskan, 1999) and green peppers 51.4 kJ mol^{-1} , (Kaymak-Ertekin, 2002).

Activation Energy in Microwave Drying

Activation energy and D_0 can be calculated from the (K-m/p) curve (Figure 11) and equation 13. Based on statistical analysis and Page model coefficients, it is noted that constant drying rate (K) increases with increasing air temperature in vacuum drying and increasing microwave power in microwave made of drying. Activation energy figures for sweet and sour pomegranate arils were recorded as 16.675 and 24.222 (W g^{-1}) respectively. In other

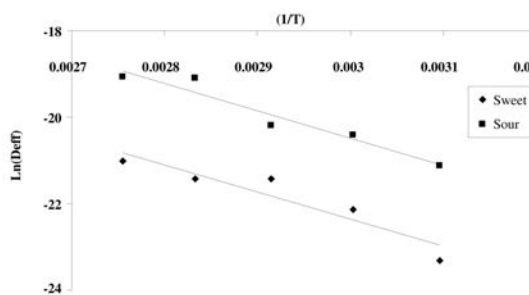

Figure 10. $\ln D_{eff}$ versus $(1/T)$ curve for sweet pomegranate arils, vacuum drying.

Table 7. Activation energy of sweet and sour pomegranate arils in vacuum drier

Vacuum drier	Sweet pomegranate	Sour Pomegranate
$Ea (\text{kJ mol}^{-1})$	52.27	52.89
R^2	0.87	0.93

words, activation energy for sour pomegranate is 31.17 higher than that for sweet pomegranate. A similar trend has been reported by Ozbek and Dadali for mint leaves (2007).

Another method for calculation of activation energy, is the calculation of the coefficients for Equation (14) from (D_{eff}) versus (m/p) curve (Figure 12), which would yield activation energy value of 16.945 (W g^{-1}) and 23.563(W g^{-1}) for sweet and sour pomegranates, respectively (Ozbek and Dadali, 2007).

The third method for calculation of activation energy is dividing the slope of $[\ln(D_{eff})- m/p]$ curve by the sample weight (Figure 13). The activation energy calculated using this method was found to be 17.220 (W g^{-1}) for sweet and 23.831(W g^{-1}) for sour pomegranate.

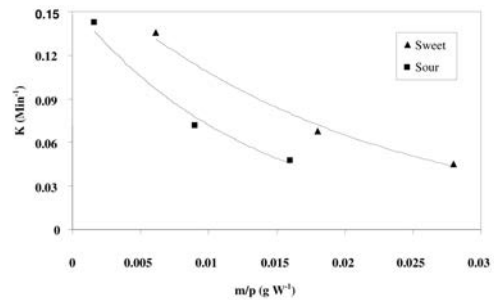

Figure 11. Variation of drying rate constant with sample weight/microwave operating power for sweet and sour pomegranate arils.

CONCLUSIONS

Drying behavior of thin layers of sweet and sour pomegranate arils was investigated in a vacuum drier at five temperature levels (50, 60, 70, 80, 90°C) and in a microwave

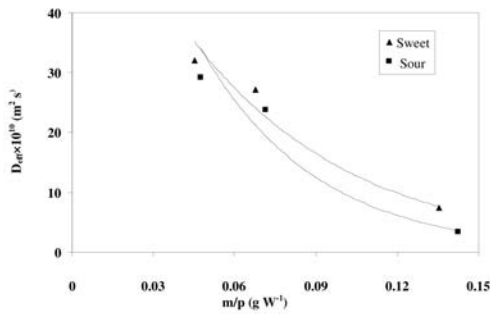

Figure 12. Relationship between D_{eff} and sample weight/microwave operating power for sweet and sour pomegranates.

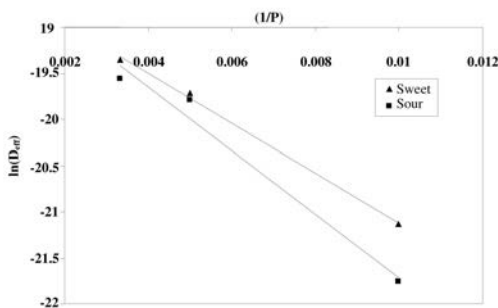

Figure 13. Variation of $\ln(D_{eff})$ with $(1/P)$ for sweet and sour pomegranate arils in microwave drying.

drier at three operating power levels (100, 200, 300W). The air temperature and vacuum level in the vacuum drier and microwave operating power in the microwave drier were factors affecting the drying time of pomegranate arils as well as constants in Page model.

Regarding goodness of fit indices (R^2 , X^2 , RMSE), Midili model (in vacuum drying) and Page model (in microwave drying) provided the best fit for the data. The entire process of dry becoming of the pomegranate arils occurred in the falling rate period.

Drying rate of pomegranate arils, in the vacuum drier, is affected by temperature and the initial moisture content, while in the microwave drier, the operative power and aril initial moisture content constitute the effective factors. Increasing the temperature in the vacuum drier and the power in the microwave drier results in increase in drying rate.

By increasing the vacuum drier temperature from 50 to 90°C, moisture diffusion for both sour and sweet varieties of pomegranate increased. The lowest moisture diffusion was obtained as $0.74 \times 10^{-10} \text{ m}^2 \text{ s}^{-1}$ whilst its maximum value being $52.5 \times 10^{-10} \text{ m}^2 \text{ s}^{-1}$. This trend was also observed when increasing the power in the microwave drier, its minimum value being $3.43 \times 10^{-10} \text{ m}^2 \text{ s}^{-1}$ vs. a maximum of $32.05 \times 10^{-10} \text{ m}^2 \text{ s}^{-1}$. Values of activation energy for sour and sweet pomegranate arils were almost similar in the case of vacuum drying, whilst they were recorded as higher for sour pomegranate in the case microwave drying.

Nomenclature

T_{abs}	Absolute air temperature (K)
χ^2	Chi-square
D_0	Constant
R^2	Correlation coefficient
K	Drying kinetic constant rate (Min^{-1})
D_{eff}	Effective diffusion coefficient ($\text{m}^2 \text{ s}^{-1}$)
E_a	Energy of activation (Kj mol^{-1})
M_e	Equilibrium moisture content (kg water kg^{-1} solids)
M_0	Initial moisture content (kg water kg^{-1} solids)
$MR_{exp,i}$	ith moisture ratio value experimentally determined
$MR_{pre,i}$	ith predicted moisture ratio value
P	Microwave power (W)
M_t	Moisture content at any time (kg water kg^{-1} solids)
M_{t+dt}	Moisture content at time $t+dt$, (kg water kg^{-1} dry matter)
M_t	Moisture content at time t (kg water kg^{-1} dry matter)
MR	Moisture ratio (dimensionless)
m	Number of drying constants
N	Number of observations
K_0	Pre-exponential constant (Min^{-1})
r_0	Radius of pomegranate aril (m).
$RMSE$	Root mean square error
m	Sample weight (g)
K_1, K_2	Slope of straight line
t	Time (Min)
R_g	Universal gas constant ($8.3143 \text{ kJ mol}^{-1}$)
v	Volume (m^3)

REFERENCES

1. Adu, B. and Otten, L. 1996. Diffusion Characteristics of White Beans during Microwave Drying. *J. Agri. Eng. Res.*, **64(1)**: 61–69.
2. Aghbashlo, M., Kianmehr, M. and Samimi-Akhijahani, H. 2007. Evaluation of Thin Layer Drying Models for Describing Drying Kinetics of Barberries (*Barberies vulgaris*). *J. food Process. Eng.*, **32**: 278-293
3. Aghbashlo, M., Kianmehr, M. and Samimi-Akhijahani, H. 2008. Influence of Drying Conditions on the Effective Moisture Diffusivity, Energy of Activation and Energy Consumption during the Thin-layer Drying of Berberis Fruit (*Berberidaceae*). *Energy Con. Manag.*, **49(10)**: 2865-2871.
4. Akgun, N. A. and Doymaz, I. 2005. Modeling of Olive Cake Thin-layer Drying Process. *J. Food Eng.*, **68**: 455–461.
5. Akpinar, E., Midilli, A. and Bicer, Y. 2003. Single Layer Drying Behaviour of Potato Slices in a Convective Cyclone Dryer and Mathematical Modeling. *Energy Con. Manag.*, **44**: 1689–1705.
6. Alibas Ozkan, I., Akbudak, B. and Akbudak, N. 2007. Microwave Drying Characteristics of Spinach. *J. Food Eng.*, **78**: 577–583.
7. Alibas, I. 2006. Characteristics of Chard Leaves during Microwave, Convective, and Combined Microwave-convective Drying. *Drying Tech.*, **24**: 1425–1435.
8. Arevalo-Pinedo, A. and Fernanda, E. X. 2007. Kinetics of Vacuum Drying of Pumpkin (*Cucurbita maxima*): Modeling with Shrinkage. *J. Food Eng.*, **76**: 562–567.
9. Babalis, S. J. and Belessiotis, V. G. 2004. Influence of Drying Conditions on the Drying Constants and Moisture Diffusivity during the Thin-layer Drying of Figs. *J. Food Eng.*, **65**: 449–458.
10. Babalis, S. J., Papanicolaou, E., Kyriakis, S. N. and Belessiotis, V. G. 2005. Evaluation of Thin-layer Drying Models for Describing Drying Kinetics of Figs (*Ficus carica*). *J. Food Eng.*, **75**: 205–214.
11. Barbosa-Canovas, G. V. and Vega-Mercado, H. 1996. *Dehydration of Foods*. First Edition, Chapman and Hall, NY, USA.
12. Bruce, D.M. 1985. Exposed-layer Barley Drying: Three Models Fitted to New Data up to 150°C. *J. Agri. Eng. Res.*, **32**: 337-347.
13. Celma, A. R., Rojas, S., Lopez, F., Montero, I. and Miranda, T. 2007. Thin-layer Drying Behaviour of Sludge of Olive Oil Extraction. *J. Food Eng.*, **80**: 1261–1271.
14. Chen, C. and Wu, P. C. 2001. Thin Layer Drying Model for Rough Rice with High Moisture Content. *J. Agri. Eng. Res.*, **80(1)**: 45–52.
15. Cheng, W. M., Raghavan, G. S. V., Ngadi, M. and Wang, N. 2006. Microwave Power Control Strategies on the Drying Process II. Phase-controlled and Cycle-controlled Microwave/Air Drying. *J. Food Eng.*, **76**: 195–201.
16. Crank, J. 1975. *Mathematics of Diffusion*. 2nd Edition, Oxford University Press, London.
17. Dadali, G., Apar, D. K. and Ozbek, B. 2007a. Microwave Drying Kinetics of Okra. *Drying Tech.*, **25**: 917–924.
18. Diamante, L. M. and Munro, P. A. 1991. Mathematical Modeling of the Thin Layer Solar Drying of Sweet Potato Slices. *Sol. Energy*, **51**: 271–276.
19. Doymaz, I. 2004. Convective Air Drying Characteristics of Thin Layer Carrots. *J. Food Eng.*, **61**: 359–364.
20. Doymaz, I. 2005. Influence of Pretreatment Solution on the Drying of Sour-cherry. *J. Food Eng.*, **78**: 591–596.
21. Doymaz, I. 2007. The Kinetics of Forced Convective Air-drying of Pumpkin Slices. *J. Food Eng.*, **79**: 243–248.
22. Drouzas, A. E. and Schubert, H. 1996. Microwave Application in Vacuum Drying of Fruits. *J. Food Eng.*, **28**: 203–209.
23. Ertekin, C. and Yaldiz, O. 2004. Drying of Eggplant and Selection of a Suitable Thin Layer Drying Model. *J. Food Eng.*, **63**: 349–359.
24. Fernando, W. J. N. and Thangavel, T. 1987. Vacuum Drying Characteristics of Coconut. *Drying Tech.*, **5(3)**: 363–372.
25. Funebo, T. and Ohlsson, T. 1998. Microwave-assisted Air Dehydration of Apple and Mushroom. *J. Food Eng.*, **38**: 353–367.
26. Gogus, F. and Maskan, M. 1999. Water Adsorption and Drying Characteristics of Okra (*Hibiscus esculentus* L.). *Drying Tech.*, **17**: 883–89.
27. Gowen, A.A., Abu-Ghannam, N., Frias, J. and Oliveira, J. 2008. Modeling Dehydration and Rehydration of Cooked Soybeans Subjected to Combined Microwave-hot-air



- Drying. *Innov. Food Sci. Emerging Tech.*, **9**: 129–137.
28. Henderson, S. M. 1974. Progress in Developing the Thin-layer Drying Equation. *Transactions ASAE*, **17**: 1167–1172.
29. Henderson, S. M. and Pabis, S. 1961. Grain Drying Theory: Temperature Affection Drying Coefficient. *J. Agri, Eng, Res.*, **6**: 169–170.
30. Hossain, M. A. and Bala, B. K. 2002. Thin Layer Drying Characteristics for Green Chilli. *Drying Tech.*, **20(2)**: 489–505.
31. Ilknur, A. 2007. Microwave, Air and Combined Microwave–air-drying Parameters of Pumpkin Slices. *LWT*, **40**: 1445–1451.
32. Jain, D. and Pathare, P. B. 2004. Selection and Evaluation of Thin Layer Drying Models for Infrared Radiative and Convective Drying of Onion Slices. *Biosys. Eng.*, **89**: 289–296.
33. Jaya, S. and Das, H. 2003. A Vacuum Drying Model for Mango Pulp. *Drying Tech.*, **21(7)**: 1215–1234.
34. Karaaslan, S. N. and Tuncer, I. K. 2008. Development of a Drying Model for Combined Microwave–fan-assisted Convection Drying of Spinach. *Biosys. Eng.*, **100**: 44–52.
35. Kaya, A., Aydin, O. and Demirtas, C. 2007. Drying Kinetics of Red Delicious Apple. *Biosys. Eng.*, **96(4)**: 517–524.
36. Kaymak-Ertekin, F. 2002. Drying and Rehydration Kinetics of Green and Red Pepper. *J. Food Sci.*, **67**: 168–175.
37. Kompany, E., Benchimol, J., Allaf, K., Ainseba, B. and Bouvier, J. M. 1993. Carrot Dehydration for Instant Rehydration: Dehydration Kinetics and Modeling. *Drying Tech.*, **11(3)**: 451–470.
38. Lahsasni, S., Kouhila, M., Mahrouz, M., Ait Mohamed, L. and Agorram, B. 2004. Characteristic Drying Curve and Mathematical Modeling of Thin-layer Solar Drying of Prickly Pear Cladode (*Opuntia ficus Indica*). *J. Food Process. Eng.*, **27(2)**: 103–117.
39. Lee, J. H. and Kim, H. J. 2009. Vacuum Drying Kinetics of Asian White Radish (*Raphanus sativus L.*) Slices. *Food Sci. Tech.*, **42**: 180–186.
40. Lewis, W. K. 1921. The Rate of Drying of Solid Materials. *Ind. Eng. Chem.*, **13**: 427–432.
41. Lin, T. M., Durance, T. D. and Seaman, C. H. 1998. Characterization of Vacuum Microwave Air and Freeze Dried Carrot Slices. *Food Res. Int.*, **4**: 111–117.
42. Litvin, S., Mannheim, C. H. and Miltz, J. 1998. Dehydration of Carrots by a Combination of Freeze Drying, Microwave Heating and Air or Vacuum Drying. *J. Food Eng.*, **36**: 103–111.
43. Menges, H. O. and Ertekin. C. 2005. Mathematical Modeling of Thin Layer Drying of Golden Apples. *J. Food Eng.*, **77**: 119–125.
44. Mohsenin, N. N. 1986. Physical Properties of Plant and Animal Materials: Structure, Physical Characteristics and Mechanical Properties. Gordon and Breach Sci. Publisher.
45. Ozbek, B. and Dadali, G. 2007. Thin-layer Drying Characteristics and Modelling of Mint Leaves Undergoing Microwave Treatment. *J. Food Eng.*, **83**: 541–549
46. Page, G. E. 1949. Factors Influencing the Maximum Rates of Air drying Shelled Corn in Thin Layers. MSc. Thesis, Purdue University.
47. Pahlavanzadeh, H., Basiri, A. and Zarrabi, M. 2001. Determination of Parameters and Pretreatment Solution for Grape Drying. *Drying Tech.*, **19(1)**: 217–226.
48. Prabhanjan, D. G., Ramaswamy, H. S. and Raghavan, G. S. V. 1995. Microwave Assisted Convective Air Drying of Thin Layer Carrots. *J. Food Eng.*, **25(2)**: 283–293.
49. Rafiee, Sh., Keyhani, A., Sharifi, M., Jafari, A., Mobli, H. and Tabatabaeefer, A. 2009. Thin Layer Drying Properties of Soybean (Viliamz Cultivar). *J. Agric. Sci. Technol.*, **11**: 289–300.
50. Rizvi, S. S. H. 1986. Thermodynamic Properties of Foods in Dehydration. In: "Engineering Properties of Foods", (Eds.): Rao, M. A. and Rizvi S. S. H.. Marcel Dekker Inc, NY.
51. Schiffman, R. F. 1992. Microwave Processing in the U.S. Food Industry. *Food Tech.*, 50–52: 56.
52. Shahrestani, N. 1998. *Berberis Fruits*. Publication of Giulan University.
53. Sharaf-Eldeen, Y. I., Blaisdell, J. L. and Hamdy, M. Y. 1980. A Model for Ear Corn Drying. *Transactions ASAE*, **23**: 1261–1271.

54. Togrul, I. T. and Pehlivan, D. 2003. Modelling of Drying Kinetics of Single Apricot. *J. Food Eng.*, **58**: 23–32.
55. Tulasidas, T. N., Ratti, C. and Raghavan, G. S. V. 1997. Modelling of Microwave Drying of Grapes. *Can. Agric. Eng.*, **39**: 57–67.
56. Valo-Pinedo, A. A. and Xidieh Murr, F. E. 2007. Influence of Pre-treatments on the Drying Kinetics during Vacuum Drying of Carrot and Pumpkin. *J. Food Eng.*, **80**: 152–156.
57. Verma, L. R., Bucklin, R. A., Endan, J. B. and Wratten, F. T. 1985. Effects of Drying Air Parameters on Rice Drying Models. *Transactions ASAE*, **28**: 296–301.
58. Walde, S. G., Balaswamy, K., Velu, V. and Rao, D. G. 2002. Microwave Drying and Grinding Characteristics of Wheat (*Triticum aestivum*). *J. Food Eng.*, **55**: 271–276.
59. Wang, J., Sun, J., Liao, X., Chen, F., Zhao, G., Wu, J. 2007. Mathematical Modeling on Hot Air Drying of Thin Layer Apple Pomace. *Food Res. Int.*, **40**: 39–46.
60. Wang, Z., Sun, J., Chen, F., Liao, X. and Hu, X. 2007. Mathematical Modelling on Thin Layer Microwave Drying of Apple Pomace with and without Hot Air Pre-drying. *J. Food Eng.*, **80**: 536–544.
61. Wong, J. Y. 2001. *Theory of Ground Vehicles*. 3rd Edition, John Wiley and Sons, Inc.
62. Yagcioglu, A., Degirmencioglu, A. and Cagatay, F. 1999. Drying Characteristic of Laurel Leaves under Different Conditions. *In Proceedings of the 7th International Congress on Agricultural Mechanization and Energy*, 26–27 May, Adana, Turkey, PP. 565–569.
63. Yaldiz, O. and Ertekin, C. 2001. Thin Layer Solar Drying of Some Vegetables. *Drying Tech.*, **19**: 583–596.

مدل ریاضی خشک کردن دانه انار با استفاده از خشک‌های تحت خلا و مایکروویو

س. مینایی، ع. متولی، ع. احمدی، م. ح. عزیزی

چکیده

در این مطالعه رفتار خشک شدن، تعیین مدل ریاضی، تاثیر شرایط مختلف بر روی آهنگ از دست دادن رطوبت و ضریب نفوذ موثر و تعیین مقادیر انرژی فعال سازی در دو گونه انار شیرین وترش با استفاده از خشک‌کن های تحت خلا و مایکروویو مورد بررسی قرار گرفت. نتایج حاصل از تحلیل رگرسیونی مدل‌های مورد بررسی نشان داد که مدل میدیلی و پیچ بهترین برازش را به ترتیب در خشک‌کن تحت خلا و مایکروویو با داده های بدست آمده دارد. خشک شدن دانه های انار در مرحله نزولی اتفاق می‌افتد. ضریب نفوذ موثر دانه های انار در خشک‌کن تحت خلا بین 0.74×10^{-10} تا 10^{-10} مترمربع بر ثانیه و در خشک‌کن مایکروویو بین $3/43 \times 10^{-10}$ تا $32/05 \times 10^{-10}$ مترمربع بر ثانیه بدست آمد. همچنین انرژی فعال سازی در خشک‌کن تحت خلا برای انار شیرین و ترش به ترتیب برابر با $52/27$ و $52/83$ کیلو ژول و در خشک‌کن مایکروویو نیز به ترتیب برای انار شیرین و ترش برابر با $17/22$ و $23/83$ کیلوژول محاسبه شد.