

***In Silico* Interactome Network Analysis and Phylogenetic Relationship of Potato Peroxidases and Catalases**

P. Taheri^{1*}

ABSTRACT

Peroxidases (POXs) and Catalases (CATs) are the main antioxidant enzymes involved in scavenging H₂O₂ in living cells. Different POXs and CATs may be capable of exhibiting interaction with the constituents of the plant cell. Whereas the activity or gene expression of POXs and CATs has been investigated in potato plants, their interactions with other proteins in this crop have not been investigated till now. Determining Protein-Protein Interaction (PPI) networks could be important in providing crucial insights into the regulation of plant defense responses to biotic and abiotic stresses. STRING analysis revealed interaction of cationic, suberization-associated anionic, and Class III peroxidases in potato with several enzymes involved in lignin biosynthesis and phenylpropanoid pathways, which was in accordance with close phylogenetic relationship of the three potato peroxidases investigated in this study. The CAT1 enzyme in potato interacted with several enzymes involved in ROS production. Phylogenetic analysis of the *CAT1* and *CAT2* genes in this plant species referred to their close relationship. Demonstrating how each isoform of these enzymes responds to environmental stimuli and how it interacts with other proteins at transcriptional, translational, and post-translational levels seems to be useful in designing novel and effective plant protection strategies against different stresses.

Keywords: Defense mechanisms, Interactome, Plant protection strategies, Protein-protein interaction.

INTRODUCTION

Resistance mechanisms, including numerous biochemical and cytomolecular changes, occur in plant defense against biotic and abiotic stresses. Defense signaling is complex and comprises mechanisms which distinguish a range of environmental stimuli. Accumulation of Reactive Oxygen Species (ROS; including Hydrogen peroxide: H₂O₂, Superoxide: O₂⁻, and Hydroxyl radical: OH[•]), known as oxidative burst, is one of the earliest plant defense responses to various biotic or abiotic stresses. Various types of ROS can enhance Hypersensitivity Response (HR) or play an important role as second messengers in resistance mechanisms leading to the

upregulation of defense-related genes and interaction with other signaling molecules (Chen, *et al.* 2013). Previously, it had been assumed that various ROS accumulate sequentially from O₂⁻ as the primary origin. Today, we know that different ROS can be produced independently by different sources, which seems reasonable because ROS accumulation must be under control of antioxidative systems to avoid toxicity (Hückelhoven and Kogel 2003). All aerobic organisms have developed antioxidant systems for controlling ROS accumulation and maintaining redox homeostasis, as well as to 'make use' of these highly reactive molecules in signal transduction, gene expression and cellular responses to biotic or abiotic stimuli

¹ Department of Plant Protection, Faculty of Agriculture, Ferdowsi University of Mashhad, Mashhad, Islamic Republic of Iran.

* Corresponding author; e-mail: p-taheri@um.ac.ir



(which is redox signaling). Uncontrolled ROS levels lead to cell death, which may enhance plant susceptibility to pathogens (Torres, *et al.* 2006). So, ROS accumulation and removal are controlled in plant-pathogen interactions. Enzymatic antioxidants such as Peroxidase (POX) and Catalase (CAT) are responsible for scavenging H_2O_2 in living cells (Barna *et al.* 2012).

The POXs are α -helical heme-containing proteins with various functions. They might be involved in H_2O_2 production (peroxidation) or in oxidizing various molecules mainly of phenolic nature. Peroxidases (EC 1.11.1.7) are oxidoreductases that catalyze the reduction of hydrogen peroxide and the concomitant oxidation of various hydrogen donors, such as phenolic and non-phenolic substrates (Carpin, *et al.* 2001). Most of the functions recognized for plant peroxidases occur in cell walls. These functions can be divided into two major types. The first is the oxidative cross-linking of several aromatic molecules and structural non-enzymatic proteins such as extensins via using H_2O_2 as an electron acceptor. This reaction leads to lignification (Ros Barceló *et al.* 1998) or production of suberin by the function of class III secreted plant peroxidases (Bernards 1999; Arrieta-Baez and Stark 2006) and also to cell wall reinforcement via formation of covalent bonds between polysaccharides such as pectin and hemicellulose (Fry 1986; Passardi, *et al.* 2005).

On the other hand, some POXs such as class III secreted POXs are involved in peroxidation by producing ROS including H_2O_2 , O_2^- , and OH^- (Bestwick, *et al.* 1999; Raggi *et al.* 2015). H_2O_2 and O_2^- are used in a Fenton-type reaction to produce OH^- , which leads to non-enzymatic cleavage of cell wall polysaccharides (Passardi *et al.* 2005; Raggi *et al.* 2015). Therefore, the POXs are capable of playing opposite functions in cell expansion, by causing both wall thickening and loosening via negatively or positively regulating ROS accumulation, depending on growth conditions (Passardi, *et al.* 2004).

Many different isozymes of POXs are present simultaneously in cell wall and other apoplastic spaces (Raggi, *et al.* 2015; Ros

Barceló, *et al.* 1989), cytoplasm (Ros Barceló, *et al.* 1989), and vacuoles (Calderon, *et al.* 1992). These enzymes have been grouped in three different categories, including soluble, ionically bound, and covalently bound POXs, depending on the treatment necessary for their release from the plant cell wall (McDougall *et al.* 1995). This suggests that different POXs may be capable of exhibiting various interactions with the constituents of the plant cell or its extracellular matrix. Despite the probable importance of these interactions for the control of POX function, the current information in this case is scarce.

The CAT (EC 1.11.1.6) is a tetrameric heme protein with four polypeptide chains, which has α -helix and β -sheet domains. It is found in all aerobic living organisms and functions in converting H_2O_2 to H_2O and O_2 (Chelikani *et al.*, 2004). This enzyme is also found in some anaerobic microorganisms such as *Methanosarcina barkeri* (Brioukhanov *et al.* 2006). It is a main enzymatic antioxidant, which protects the cells from harmful damages of oxidative burst. This enzyme has one of the highest turnover numbers among all enzymes, as one molecule of CAT can scavenge millions of H_2O_2 molecules in each second (Goodsell, 2016). Catalase is located in the peroxisomes of eukaryotic cells (Alberts *et al.*, 2002.). Peroxisomes in plant cells are involved in photorespiration (the use of O_2 and production of CO_2) and symbiotic nitrogen fixation (the breaking apart of N_2 to reactive nitrogen atoms). Plant catalases can be classified into three classes based on the expression profiles of the *CAT* genes (Willekens, *et al.* 1994; Willekens *et al.* 1995). Class I of catalases includes isoforms which are highly expressed in leaves and involved in the removal of H_2O_2 produced during photorespiration. The class II of catalases includes the isoforms which are generally found in vascular tissues and its physiological role is unclear, so far (Dat *et al.* 2000; Feierabend 2005). The class III of catalases includes isoforms which are expressed in seeds and young seedlings and

believed to be involved in the removal of H_2O_2 during fatty acid degradation in glyoxysomes (Willekens, *et al.* 1994; Willekens *et al.* 1995).

Both CATs and POXs are involved in protecting living cells and tissues against toxic effects of ROS, including oxidative damage of DNA, proteins, and lipids (Halliwell and Gutteridge, 1989; Novo and Parola 2008). Whereas the activity or gene expression of POXs and CATs at different stress conditions have been investigated in potato plants, their interactions with other proteins in this crop plant is not investigated till now. Determining Protein-Protein Interaction (PPI) networks, which is also known as interactome (Braun *et al.* 2013), could be important in providing crucial insights into the regulation of plant developmental, physiological, pathological and defense-related processes against various biotic and abiotic stresses. Additionally, any interaction between plant proteins and pathogenic organism proteins will also increase understanding of the plant proteome and defense networks against pathogens.

In potato (*Solanum tuberosum*), various types of POX, such as cationic peroxidase (poxMM), suberization-associated anionic peroxidase, lignin-forming anionic peroxidase, phospholipid hydroperoxide glutathione peroxidase, ascorbate peroxidase, cell wall peroxidase, thioredoxine peroxidase, class III peroxidases and several isoenzymes of peroxidase are identified, so far (Espelie and Kolattukudy, 1985; Yu, *et al.* 2010). Three isozymes of CAT, including CAT1, CAT2, and CAT3 are reported in potato till now (Santos *et al.* 2006).

Interactome analysis methods could be classified into three groups, including *in vitro*, *in vivo*, and *in silico* approaches. Bioinformatics predictions, also referred to as *in silico* analysis, can suggest interactions that have avoided recognition by other methods or those of proteins that have not been investigated yet.

The objectives of this study were to: (i) Investigate the interactome for each of the main peroxidases (including the cationic peroxidase poxMM, suberization-associated anionic peroxidase POX, and a member of Class III of POXs) in potato, (ii) Determine interaction networks for each of the three isozymes of CAT in this plant species, (iii) Predict interaction of these antioxidant proteins with each other via *in silico* analysis, and (iv) Determine phylogenetic relationships of the POX and CAT isozymes in potato for getting more insight about unknown functions and possible interactions of these important redox-related enzymes.

MATERIALS AND METHODS

Bioinformatic Analysis of Protein-Protein Interaction Networks.

Interaction of CAT1, CAT2, CAT3, poxMM, suberization-associated peroxidase (POX) and a peroxidase belonging to Class III of POXs (CIIIPOX) with their predicted functional partners in potato was investigated based on bioinformatic analyses by the Search Tool for the Retrieval of Interacting Genes (STRING) software version 10 (Szklarczyk *et al.*, 2015). Furthermore, the interactome of the above mentioned CATs and POXs with each other was analyzed using the same software.

Sequence Analysis and Construction of Phylogenetic Tree.

Sequences of the *poxMM*, *CAT1* and *CAT2* genes of potato were obtained from NCBI and compared with other *peroxidase* and *catalase* genes in *Arabidopsis thaliana*, *Solanum lycopersicum* (tomato), and *Oryza sativa* (rice). Sequence alignments and editions were performed using the BioEdit Sequence Alignment Editor (Tom Hall, Ibis therapeutics, Carlsbad, CA, USA). Then, the phylogenetic trees were constructed using Treecon software (Van de Peer, and



Wachter, 1994). Bootstrap re-samplings with 1,000 trials were used for estimating the confidence degree in the clustering order of phylogenetic tree obtained from the sequences.

RESULTS

Bioinformatic Analysis of Protein-Protein Interactions

For detailed explanation of a protein's function in basal resistance, knowledge about its interaction associates is a major prerequisite. STRING (Search Tool for the Retrieval of Interacting Genes/Proteins) is one of the best sites to hold experimental, predicted and transferred protein-protein associations, together with interactions obtained through text mining. Using the STRING v10 database (<http://STRING-db.org/>), we investigated the known and predicted interactions among each of the *poxMM*, *POX*, *CIIPPOX*, *CAT1*, *CAT2*, and *CAT3* with other proteins in potato. In addition, interaction of these proteins with each other was investigated. The protein networks consist of information concerning both nodes (proteins) and edges (interactions). Each node in the network shows a preview to 3D protein structure, and can be clicked to reveal a pop-up window with more information about the protein including its annotation, structure, and homology (Szklarczyk *et al.* 2015). Protein nodes that are enlarged indicate the availability of 3D protein structure information. Each edge in the obtained networks represents a known or predicted interaction, and leads to a pop-up window with information about the basic evidence and the interaction confidence scores. Colored lines between the proteins indicate different types of interaction. According to the STRING analysis, cationic peroxidase (*poxMM*) in potato had interaction with glycosyltransferase, aminotransferases, cinnamyl alcohol dehydrogenase, alcohol

dehydrogenase and the isozymes of phenylalanine ammonia-lyase (Figure 1-a). However, no information about co-expression of the *poxMM* with other genes of this network was found in database.

Suberization-associated anionic Peroxidase (*POX*) interaction analysis based on databases (Figure 1-b) revealed the association of this protein with the same proteins that were found in the interactome of *poxMM*. In addition, the same proteins were found in the interactome of Class III Peroxidase (*CIIPPOX*) in potato (Figure 1-c). Interaction analyses data obtained for all three types of potato peroxidases tested in this study were based on databases and no evidence of neighborhood, gene fusion, and coexpression was observed in the interactome of these proteins (Figure 1).

Bioinformatic analysis revealed that the *CAT1* in potato had interaction with Peroxisomal Targeting Signal (*PTS*) 1 receptor, Glycolate Oxidases (*GOX*), (s)-2-hydroxy-acid oxidases, Superoxide Dismutase (*SOD*), and trehalose-6-phosphate synthase (Figure 2). The STRING analyses revealed co-expression of the *CAT1* with putative homologs of other genes in the obtained network, except for the *PTS* (Figure 2).

Proteins obtained in the interaction network of *CAT1* were also observed in the STRING results for *CAT2*, except *SOD*. Co-expression of *CAT2* with all genes in its network was predicted as observed for their putative homologs in other species (Figure 3).

Interaction network of *CAT3* in potato consisted of the same proteins, which were observed in the interactome of *CAT2* (Figure 4). In the interactome of each catalase investigated, the evidence of coexpression of the gene encoding the main protein of the network (*CAT1*, *CAT2*, or *CAT3*) with the genes associated with other proteins in each network, except the gene of peroxisomal targeting signal 1 receptor, was observed.

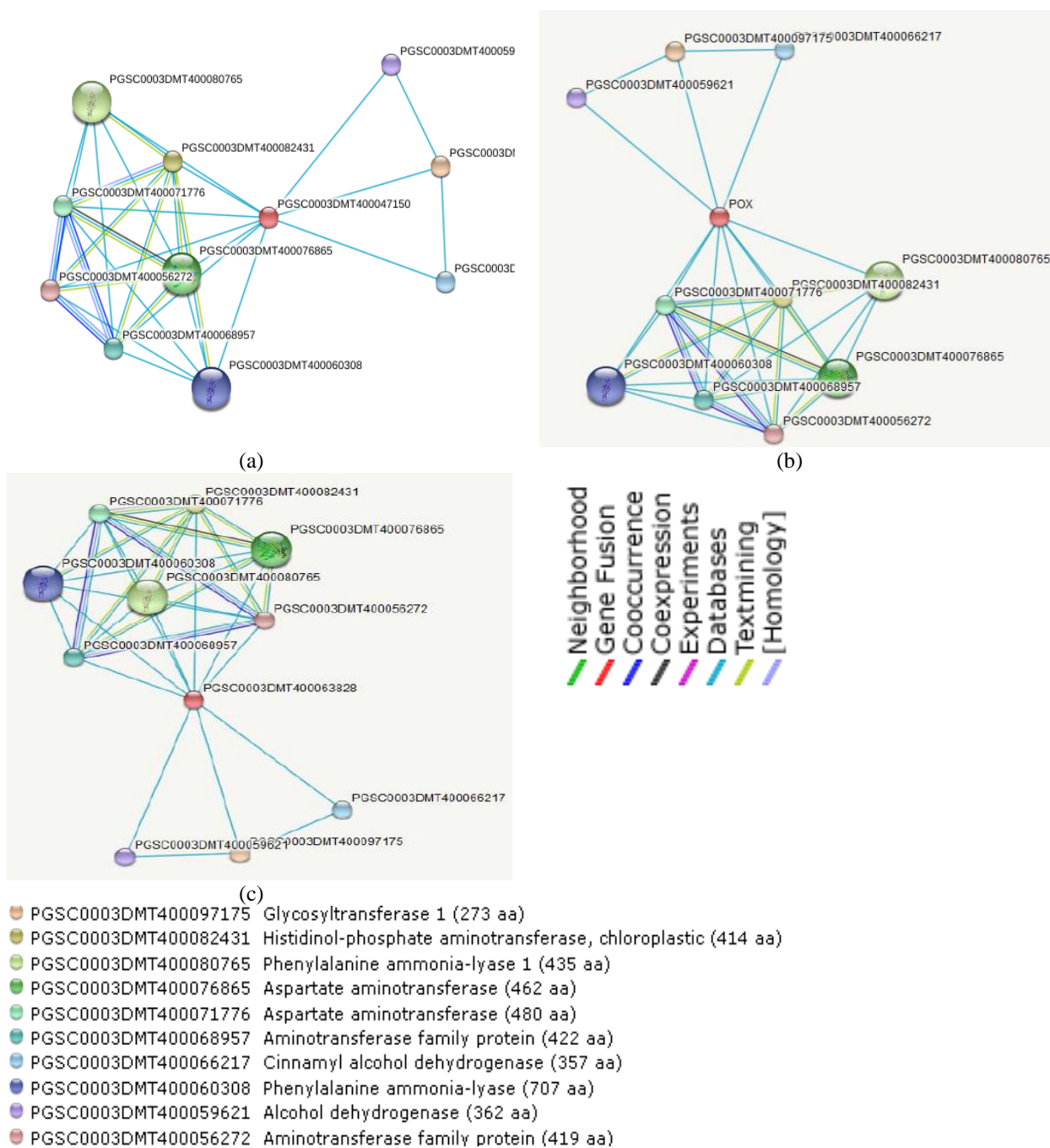

Figure 1. Interaction of cationic peroxidase 1 (a) (poxMM, Identifier: PGSC0003DMT400047150), suberization-associated anionic Peroxidase (b) (POX, PGSC0003DMT400057522), and Class III Peroxidase (c) (CHIPOX, PGSC0003DMT400063828) with their functional partners in *Solanum tuberosum* based on bioinformatic analysis using STRING software (version 10).

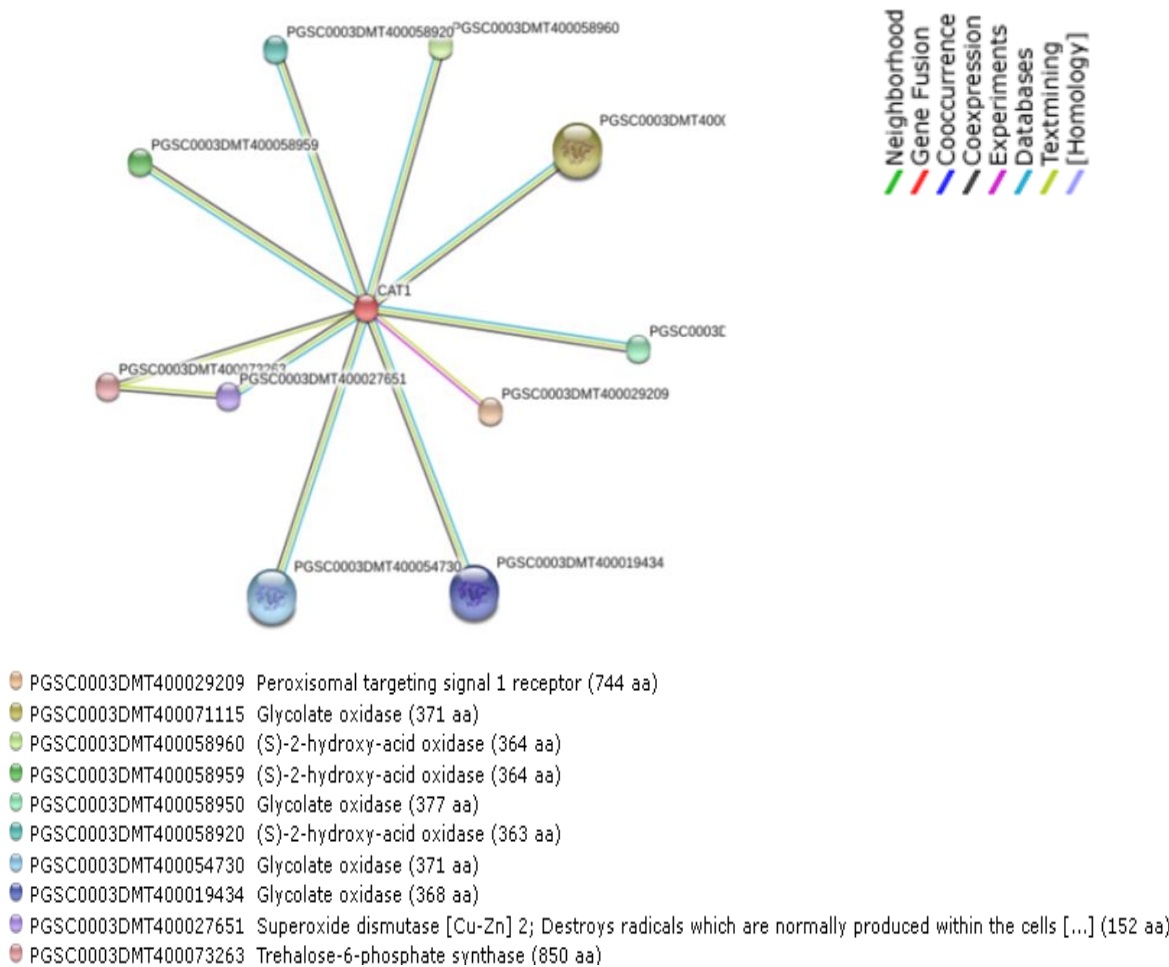

Figure 2. Interaction of Catalase 1 (CAT1, Identifier: PGSC0003DMT400075611) protein with its functional partners in *Solanum tuberosum* based on bioinformatic analysis using STRING software (version 10).

No interactions were observed among the CAT1, CAT2, CAT3, poxMM, POX, and CIIPOX in *S. tuberosum* (Figure 5-a). Whereas, association analysis of Peroxidases (POXs) in this plant species revealed the presence of interactions among 15 out of 132 POXs (Figure 5-b). As is shown in Figure 5-b, most of the interactions in this network were based on text mining. Association of glutathione peroxidases (169 and 170 aa), thioredoxin peroxidases (162, 267, and 272 aa), and an ascorbate peroxidase (287 aa) was also observed based on the data obtained by various experiments, which are shown as pink lines. In addition, coexpression might occur in the interaction of the gene encoding thioredoxin peroxidase 1 (169 aa) with the genes associated with each of the ascorbate

peroxidase (287 aa), phospholipid hydroperoxide glutathione peroxidase (169 aa), glutathione peroxidase (170 aa), and thioredoxin peroxidases (267 and 272 aa). Coexpression of the thylakoid-bound ascorbate peroxidase with thioredoxin peroxidases was also observed in Figure 5-c.

Comparative Molecular Phylogeny of the CAT and POX Genes in Potato and other Plants.

To better understand POX and CAT sequence variance and similarities among potato genes and other plants, a phylogenetic tree was constructed using multiple

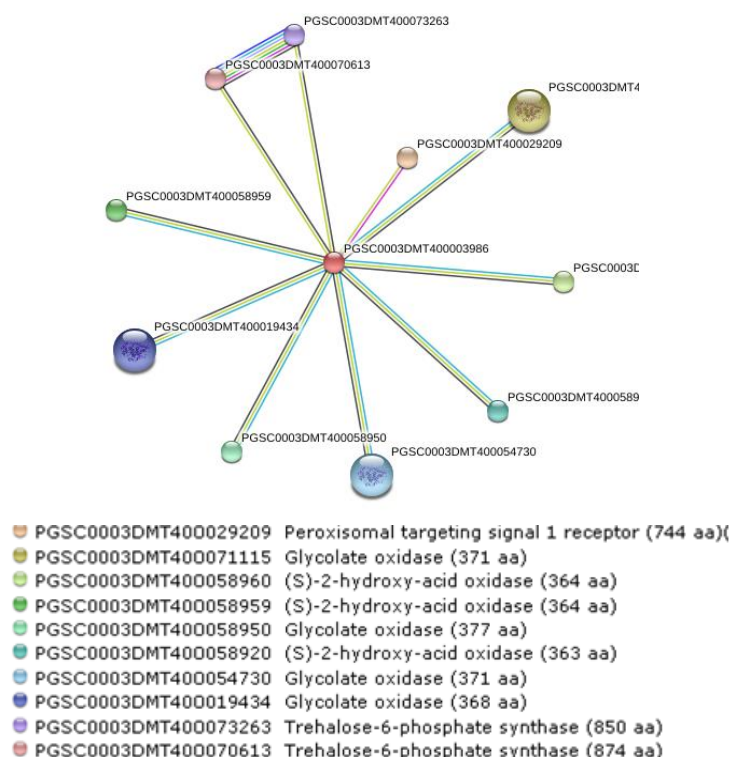

Figure 2. Interaction of Catalase 1 (CAT1, Identifier: PGSC0003DMT400075611) protein with its functional partners in *Solanum tuberosum* based on bioinformatic analysis using STRING software (version 10).

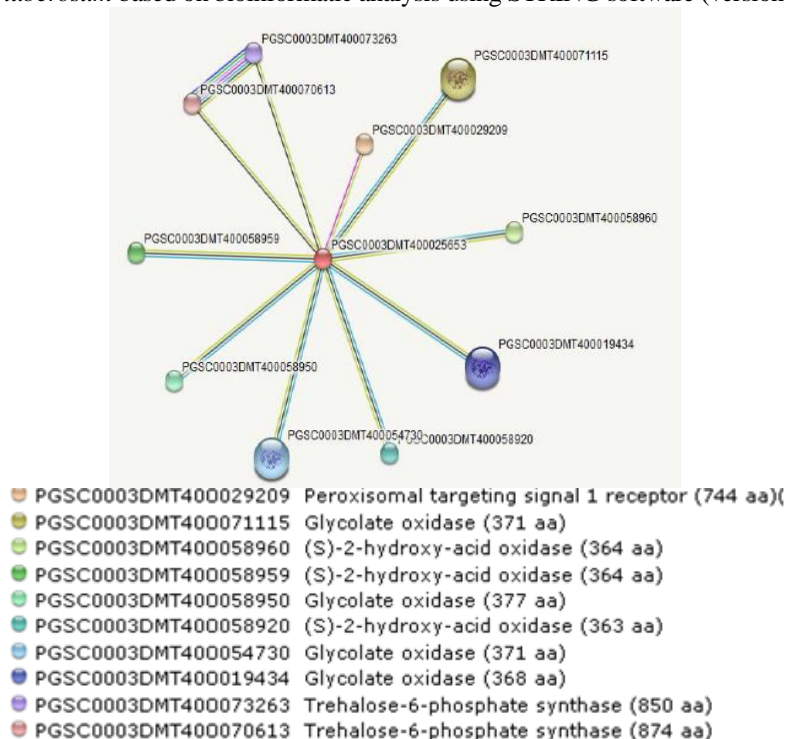

Figure 4. Interaction of Catalase 3 (CAT3, Identifier: PGSC0003DMT400025653) protein with its functional partners in *Solanum tuberosum* based on bioinformatic analysis using STRING software (version 10).

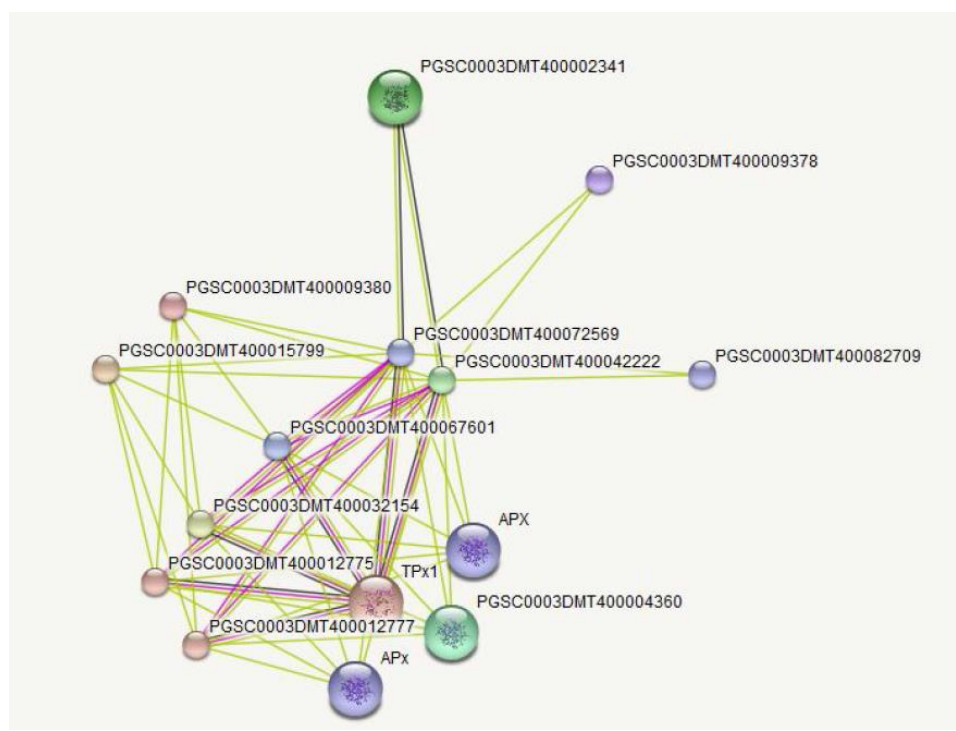
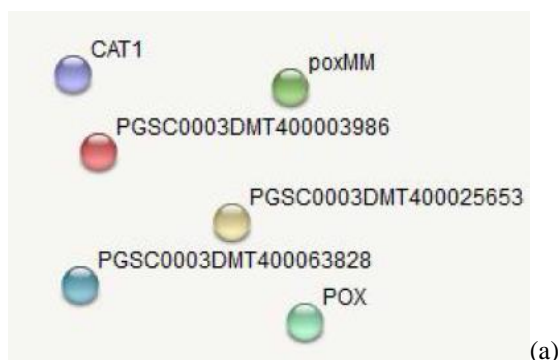

Figure 5. Interactome of catalases and peroxidases in potato. **(A)** Interactome of Catalase 1 (CAT1), Catalase 2 (CAT2), Catalase 3 (CAT3), cationic peroxidase 1 (poxMM), suberization-associated Peroxidase (POX), and Class III Peroxidase (CIIIPOX) based on bioinformatic analysis using STRING software (version 10). **(B)** Interactome of Peroxidases (POXs) in potato (15 out of 132 POXs showed interaction). Edges represent protein-protein associations are meant to be specific and meaningful, i.e. proteins jointly contribute to a shared function; this does not necessarily mean they are physically binding each other.

sequence alignment. Phylogenetic tree revealed that the cationic peroxidase of Potato (poxMM) and suberization-Associated Peroxidase (POPA) were clustered in a group together with the TMP1 and TAP1 genes, which are anionic peroxidases in tomato. Other Tomato Peroxidases (TPX1, TPX2, and pox3) were grouped together in the next cluster and the rice Cationic Peroxidase (POC1), which was

used as an out group, was clearly separated from other peroxidase genes analyzed (Figure 6a).

Interestingly, the *CAT1* and *CAT2* genes in potato clustered together with high bootstrap value of 92 percent and showed high similarity with isoforms of *CAT1* in tomato. The *catalase* genes of *Arabidopsis* had high similarity with the tomato *CAT2* and the *CAT* of a japonica cultivar of rice (Figure 6-b).

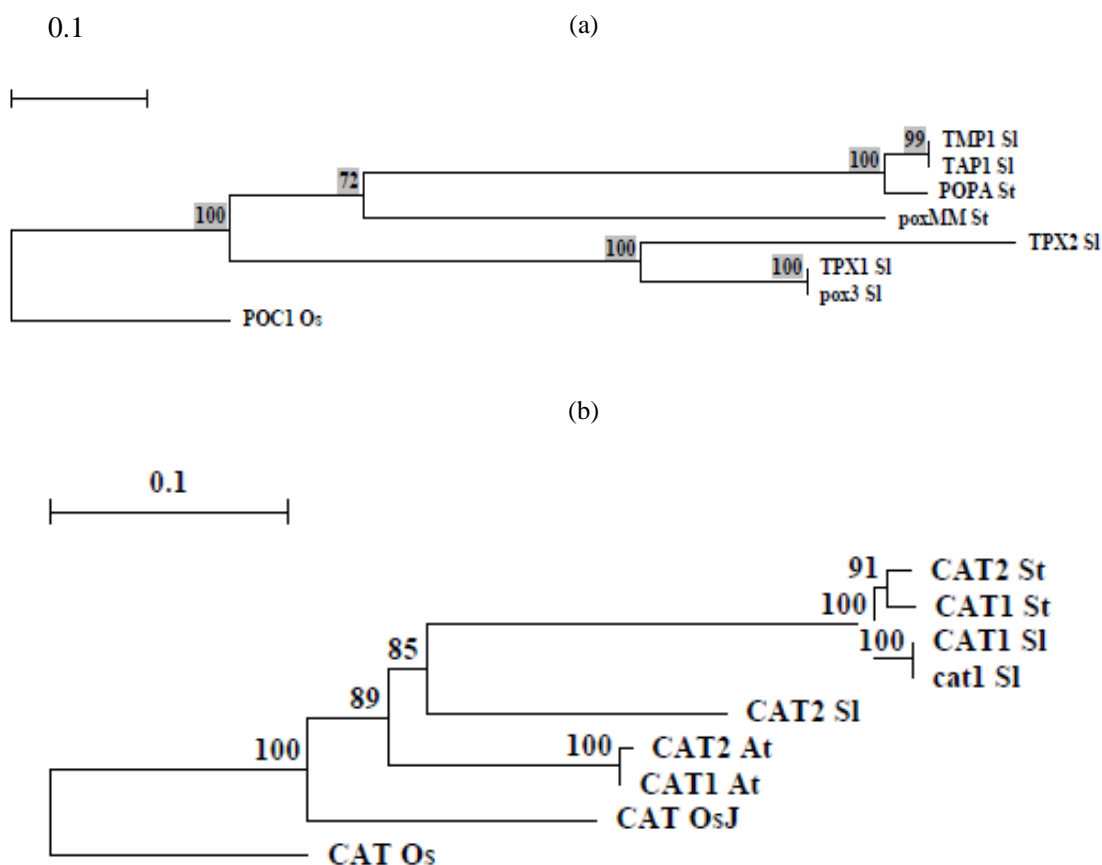

Figure 6. Rooted neighbor-joining phylogenetic trees of plant peroxidases (A) and catalases (B) constructed in Treecon software. The gene names are mentioned next to the branches followed by abbreviation of the scientific name of corresponding plant species. Sl, *Solanum lycopersicum*; St, *S. tuberosum*; Os, *Oryza sativa*; OsJ, *O. sativa* Japonica cultivar; At, *Arabidopsis thaliana*. The complete sequence of other plant peroxidases and catalases were not in the NCBI database. GenBank accession numbers of the genes are depicted after the gene names here: *TMP1 Sl*, NM_001309316; *TAP1 Sl*, X15853, *POPA St* (Suberization-associated peroxidase), XM_006347106.2; *poxMM St*, DQ925471.1; *TPX2 Sl*, L13653.1; *TPX1 Sl*, L13654.1; *pox3 Sl*, NM_001302921; *POCI Os*, AF247700; *CAT2 St*, AY500290; *CAT1 St*, U27082; *cat1 Sl*, M93719.1; *CAT1 Sl*, NM_001247898.1; *CAT2 Sl*, NM_001247257; *CAT1 At*, AY054663; *CAT2 At*, X64271.1; *CAT OsJ*, D2648.1; *CAT Os*, AB020502.

DISCUSSION

Proteins control all biological systems in a cell, and as many proteins perform their roles independently, the vast majority of proteins interact with others for proper biological activities. Investigating protein-protein interactions by bioinformatics or via

various *in vitro* and *in vivo* methods (reviewed by Rao *et al.* 2014) is critical to understand protein functions in plant defense responses.

A very good software for data integration and analysis of protein-protein interaction networks (in terms of methods, resources, and graphical display) is the Search Tool for the Retrieval of Interacting Genes/Proteins (STRING) (Szklarczyk, *et al.*, 2011). This database combines and analyzes several data points to predict functional linkages and



physical interactions between proteins. It takes extensive advantage of genome context methods (gene neighboring, gene split/fusion, and phylogenetic profile), clusters of orthologous genes, coexpression data, experimental and predicted knowledge obtained from biological databases, and the literature to assign a probabilistic confidence score to each functional association (Braun *et al.* 2013). Primarily, the STRING database was focused on prokaryotes, but now it manages more than 1,000 sequences not only from prokaryotes but also for eukaryotes such as fungi, animals, and plant species including potato.

According to the STRING analysis, cationic peroxidase (poxMM) in potato had interaction with several genes/proteins involved in lignin biosynthesis and phenylpropanoid pathways, such as cinnamyl alcohol dehydrogenase, alcohol dehydrogenase, and the isozymes of phenylalanine ammonia-lyase. In addition, the poxMM had association with glycosyltransferase, which strongly controls phenylpropanoid pathway (Aksamit-Stachurska *et al.* 2008.), and also with aminotransferases, which are involved in phenolics production (Ma, *et al.* 2013; Tohge, *et al.* 2013). However, any information about co-expression of the poxMM with other genes of this network was not found in the database, which could be the subject of future researches in this plant species.

The same proteins that were found in the interaction network of poxMM were also observed in the interactomes of suberization-associated anionic Peroxidase (POX) and Class III Peroxidase (CIIIPOX) in potato. This data indicated similar functional properties and close relationship of the three potato peroxidases investigated in this study. In the phylogenetic tree, the poxMM showed high similarity to the TAPI of tomato that is involved in suberization. So, the poxMM might be involved in suberization or other phenolics production in potato cells that should be investigated in future researches.

Plants contain multiple forms of catalase, which may reveal various functions of this antioxidative enzyme (Feierabend, 2005). Higher plants generally have three main isoforms of CAT including CAT1, CAT2, and CAT3 (Feierabend, 2005; Heinze and Gerhardt 2002). The CAT1 in potato had interaction with superoxide dismutase (SOD) as a potent scavenger of O_2^- . Both CAT1 and CAT2 had association with various isozymes of Glycolate Oxidase (GOX) as alternative sources for H_2O_2 production in peroxisomes, which led to callose deposition (Rojas *et al.*, 2012.) that is a main defense response against several phytopathogens (Hukkanen, *et al.* 2007; Noorbakhsh and Taheri, 2016). Interaction of both the CAT1 and CAT2 with peroxisomal targeting signal 1 receptor, (s)-2-hydroxy-acid oxidase, and trehalose-6-phosphate synthase was also observed in the STRING analysis. All peroxisomal proteins, such as GOX, are synthesized in the cytoplasm and then must be directed to the peroxisome. The first step in this process is binding the protein to a receptor, which directs the complex to the peroxisome. The receptors bind to a region of the peroxisomal protein that is called Peroxisomal Targeting Signal (PTS). The (s)-2-hydroxy-acid oxidase, found in the interaction network of both CAT1 and CAT2, is involved in phenolics production pathway (Khadem and Marles, 2010). Trehalose-6-Phosphate Synthase (TPS), which was associated with both CAT isozymes in potato, is an important enzyme in the trehalose biosynthetic pathway. Trehalose contents, which play a key function in metabolic regulation and plant resistance to biotic and abiotic stresses, are modulated by the TPS (Xie *et al.* 2015). So, detailed investigations on the role of TPS in potato defense against various destructive fungal and Oomycete pathogens such as *Alternaria* spp., *Rhizoctonia solani*, *Phytophthora infestans* and its association with *in planta* levels of ROS, enzymatic and non-enzymatic antioxidants could be an interesting subject of future investigations. The CAT1 of potato

is classified in class I of catalases, which are involved in removing H₂O₂ from plant cells, whereas potato CAT2 belongs to Class II of catalases, with a role in stress protection and lignin formation (Almeida *et al.* 2005). Presence of the same proteins in the interaction networks obtained for CAT2 and CAT3 in potato suggested that the isozymes of CAT might have similar functions. It is known that CAT3 is a powerful H₂O₂ scavenger during degradation of fatty acids in glyoxysomes (Willekens, *et al.* 1994; Willekens, *et al.* 1995). Therefore, CAT2 in potato might be involved in this process, which needs to be investigated experimentally. Bioinformatic analyses in the present work revealed no interaction among different CATs and POXs in potato. Interaction analysis of POXs in potato revealed that 15 out of 132 of these antioxidant enzymes interacted with each other with a complex network. Most of these interactions were obtained via the STRING software using textmining, and some of them by the experimental and coexpression data. So, proving all of the observed interactions among potato POXs using valid *in vitro* and *in vivo* experiments seems to be necessary.

Phylogenetic analyses revealed the relationship among various types of peroxidases in potato compared to those of tomato. The fact that suberization-Associated Peroxidase (POPA) in potato was closely related to the anionic peroxidases in tomato, including TMP1 and TAP1, suggested the possibility of anionic nature for the POPA, which needs further investigations.

Our data obtained via phylogenetic analysis of the potato *CAT1* and *CAT2* genes were in accordance with a previous report by (Frugoli *et al.* 1998) referring to their close phylogenetic relationship, whereas, (Santos *et al.* 2006) reported that potato *CAT1* and *CAT2* genes were not phylogenetically closely related. The *CAT1* belongs to the class I of catalases and is associated with photorespiration, but *CAT2* belongs to the class II of catalases and is associated with

senescence and other unknown physiological and cellular processes (Feierabend, 2005; Santos *et al.* 2006). The genes encoding class III of catalases in potato, including isoforms expressed in seeds and young seedlings involved in H₂O₂ removal, were not found in the gene banks. So, investigating their phylogenetic correlation with other *CAT* genes was not possible in this study and remains as a subject for future researches. Knowledge on the role of POXs and CATs in plant responses to various biotic and abiotic stresses, which is studied in several plant species (Noorbakhsh, and Taheri 2016; Touiserkani and Haddad, 2012; Abbasi, *et al.* 2014), and their interaction with other proteins and phylogenetic relationships is essential for analyzing new hypotheses about the mechanisms of ROS detoxification and using these findings for designing novel plant protection methods against various environmental stimuli.

CONCLUSIONS

This study provides information on phylogenetic structure and protein-protein interaction network to understand the critical function of peroxidases and catalases as the main antioxidants of potato, which are involved in plant responses to various biotic and abiotic stresses. Findings obtained in this work present the opportunity for further *in vitro*, *in vivo*, and *in silico* assays, which can provide a clearer demonstration about cytomolecular and physiological roles of peroxidases and catalases in potato. These proteins could be involved not only in the ROS homeostasis, but also possibly in other yet unknown signal transduction pathways during development of different tissues, and through interaction of the host plant with various phytopathogens having different lifestyles. Identification of protein-protein interaction networks could be essential in providing critical insights into the regulation of plant defense responses against different environmental stresses. Additionally, any



interaction between plant proteins and pathogenic organism proteins will also increase understanding of the plant proteome and defense networks against phytopathogens. Therefore, demonstrating how each isoform of these antioxidant enzymes responds to various environmental stimuli and how it interacts with other proteins at transcriptional, translational, and post-translational levels seems to be useful in designing novel and effective plant protection strategies against harmful agents. The information obtained in this study about POXs and CATs interactome networks and phylogenetic analysis will help researchers in the field of oxidative burst and of biotic and abiotic stresses to design and test new hypotheses about the mechanisms of ROS scavenging and their critical roles in plant defense mechanisms in a more holistic manner.

REFERENCES

1. Abbasi, A. R., R. Sarvestani, B. Mohammadi, A. Bagheri, 2014. Drought Stress-induced Changes at Physiological and Biochemical Levels in some Common Vetch (*Vicia sativa* L.) Genotypes”, *J. Agr. Sci. Tech.*, **16**: 505-516.
2. Aksamit-Stachurska, A., A. Korobczak-Sosna, A. Kulma, and J. Szopa, 2008. Glycosyltransferase Efficiently Controls Phenylpropanoid Pathway, *BMC Biotechnol.*, vol. 8, DOI: 10.1186/1472-6750-8-25,
3. Alberts, B., A. Johnson, J. Lewis, M. Raff, K. Roberts, and P. Walter, 2002. Peroxisomes. In: “*Molecular Biology of the Cell*”, (4th ed.). New York: Garland Science Press. Pp.335-341
4. Almeida, J. M., F. Fidalgo, A. Confraria, A. Santos, H. Pires, and I. Santos, 2005. Effect of Hydrogen Peroxide on Catalase Gene Expression, Isoform Activities and Levels in Leaves of Potato Sprayed with Homobrassinolide and Ultrastructural Changes in Mesophyll Cells”, *Funct Plant Biol.*, **32(8)**: 707-720,
5. Arrieta-Baez, D. and Stark, R. E. 2006. Modeling Suberization with Peroxidase-Catalyzed Polymerization of Hydroxycinnamic Acids: Cross-Coupling and Dimerization Reactions. *Phytochem.*, **67(7)**: 743-753.
6. Barna, B. B., Fodor, J., Herrach, B. D., Pogony, M. and Kiraly, Z. 2012. The Janus Face of Reactive Oxygen Species in Resistance and Susceptibility of Plants to Necrotrophic and Biotrophic Pathogens. *Plant Physiol. Biochem.*, **59(2)**: 37-43.
7. Bernards, M. A., W. D. Fleming, W. D., Llewellyn, D. B., Priefer, R., Yang, X., Sabatino, A. and Plourde, G. L. 1999. Biochemical Characterization of the Suberization-Associated Anionic Peroxidase of Potato”. *Plant Physiol.*, **121(1)**: 135-145.
8. Bestwick, C., P. Bolwell, J. Mansfield, M. Nicole, and Wojtaszek, P. 1999. Generation of the Oxidative Burst: Scavenging for the Truth. *Trends Plant Sci.*, **4(3)**: 88-89.
9. Braun, P., S. Aubourg, J. Van Leene, G. De Jaeger, and C. Lurin, 2013. Plant Protein Interactomes, *Ann. Rev. Plant Biol.*, **64(6)**: 161-187,
10. Brioukhanov, A. L., A. I. Netrusov, and R. I. Eggen, 2006. The Catalase and Superoxide Dismutase Genes Are Transcriptionally Up-regulated Upon Oxidative Stress in the Strictly Anaerobic Archaeon *Methanosarcina barkeri*, *Microbiology*, **152(6)**: 1671-1677,
11. Calderon, A. A., J. M. Zapata, M. A. Pedreno, R. Munoz, and A. Ros Barcelo, 1992. Levels of 4-hydroxystilbene-Oxidizing Isoperoxidases Related to Constitutive Disease Resistance in In Vitro-Cultured Grapevine, *Plant Cell, Tiss Org Cult*, **29(2)**: 63-70,
12. Carpin, S. S., Crèvecoeur, M., De Meyer, M., Simon, P., Greppin, H. and Penel, C. 2001. Identification of Ca²⁺- Pectate Binding Site on an Apoplasmic Peroxidase. *Plant Cell*, **13(3)**: 511-520.
13. Chelikani, P., I. Fita, and P. C. Loewen, 2004. Diversity of Structures and Properties Among Catalases. *Cell Mol. Life Sci.*, **61(2)**: 192-208,
14. Chen, Y. J., Lyngkj, M. F. and Collinge, D. B. 2013. Future Prospects for Genetically Engineering Disease-Resistant Plants. In: “*Molecular Plant Immunity*”, (ed.): Sessa, G. Willey-Blackwell Press, USA, PP.251-269.
15. Dat, J., S. Vandenabeele, E. Vranova, M. Van Montagu, D. Inzé, and F. Van

- Breusegem, 2000. Dual Action of the Active Oxygen Species During Plant Stress Responses, *Cell Mol. Life Sci.*, **57**: 779-795,
16. Espelie, K. E., and P. E. Kolattukudy, 1985. Purification and Characterization of an Abscisic Acid-inducible Anionic Peroxidase Associated with Suberization in Potato (*Solanum tuberosum*)", *Arch Biochem. Biophys.*, **240(2)**: 539-545.
 17. Feierabend, J., 2005. Catalases in Plants: Molecular and Functional Properties Role in Stress Defence, In "Antioxidants and reactive oxygen species in plants". (Ed): N. Smirnoff, Blackwell Publishing: Oxford, pp. 101-140.
 18. Frugoli, J. A., M. A. McPeck, T. L. Thomas, and C. R. McClung, 1998. Intron Loss and Gain During Evolution of the Catalase Gene Family in Angiosperms, *Genetics*, **149(1)**: 355-365,
 19. Fry, S. C. 1986. Cross-Linking of Matrix Polymers in the Growing Cell Walls of Angiosperms. *Ann. Rev. Plant Physiol.*, **37(1)**: 165-186.
 20. Goodsell, D. S. 2016 "Catalase". Molecule of the Month". RCSB Protein Data Bank. Retrieved, August 2016.
 21. Halliwell, B., and J. M. C. Gutteridge, 1989. Free Radicals in Biology and Medicine, Clarendon Press, Oxford, UK. PP. 33-62.
 22. Heinze, M., B. Gerhardt, 2002. Plant Catalases, In: "Plant Peroxisomes: Biochemistry, Cell Biology and Biotechnological Application". Eds: A. Baker, I. A. Graham, Kluwer academic Publishers: Dordrecht, pp. 103-140.
 23. Hüchelhoven, R. and Kogel, K. H. 2003. Reactive Oxygen Intermediates in Plant-Microbe Interactions: Who Is Who in Powdery Mildew Resistance. *Planta*, **216(6)**: 891-902.
 24. Hukkanen, A. T., H. I. Kokko, A. J. Buchala, G. J. McDougall, D. Stewart, S. O. Kärenlampi, and R. O. Karjalainen, 2007. Benzothiadiazole Induces the Accumulation of Phenolics and Improves Resistance to Powdery Mildew in Strawberries, *J. Agric. Food Chem.*, **55(5)**: 1862-1870.
 25. Khadem, S., and R. J. Marles, 2010. Monocyclic Phenolic Acids; Hydroxy- and Polyhydroxybenzoic Acids: Occurrence and Recent Bioactivity Studies, *Molecules* **15**, pp. 7985-8005,
 26. Ma, X. H., Y. Ma, J. F. Tang, Y. L. He, Y. C. Liu, X. J. Ma, Y. Shen, G. H. Cui, H. X. Lin, Q. X. Rong, J. Guo, and L. Q. Huang, 2015. The Biosynthetic Pathways of Tanshinones and Phenolic Acids in *Salvia Miltiorrhiza*, *Molecules*, **20(9)**: 16235-16254.
 27. McDougall, G. J. and I. M. Morrison, 1995. Ionically-bound and Covalently-Bound Wall Peroxidases Differ in Their Substrate Specificity, *Biochem. Soc. Transact*, **23(2)**: 150.
 28. Noorbakhsh, Z., and P. Taheri, 2016. Nitric Oxide: A Signaling Molecule Which Activates Cell Wall-associated Defense of Tomato Against *Rhizoctonia solani*, *Eur. J. Plant Pathol.*, **144(3)**: 551-568,
 29. Novo, E., and M. Parola, 2008. Redox Mechanisms in Hepatic Chronic Wound Healing and Fibrogenesis. *Fibrogen Tiss. Rep.*, **1(1)**: 1-58,
 30. Passardi, F., C. Penel, and C. Dunand, 2004. Performing the Paradoxical: How Plant Peroxidases Modify the Cell Wall, *Trends Plant Sci.*, **9(11)**: 534-540,
 31. Passardi, F., F. Cosio, C., Penel, C. and Dunand, C. 2005. Peroxidases Have More Functions than a Swiss Army Knife. *Plant Cell Rep.*, **24(5)**: 255-265.
 32. Raggi, S., A. Ferrarini, M. Delledonne, C. Dunand, P. Ranocha, G. De Lorenzo, F. Cervone, and S. Ferrari, 2015. The *Arabidopsis thaliana* Class III Peroxidase AtPRX71 Negatively Regulates Growth Under Physiological Conditions and in Response to Cell Wall Damage, *Plant Physiol.*, **169(4)**: 2513-2525.
 33. Ros Barceló, A., R. Muñoz, and F. Sabater, 1989. Substrate Specificity of Soluble Lupin Isoperoxidases, *Biol. Plant*, **31(1)**: 161-167,
 34. Rojas, C. M., M. Senthil-Kumar, K. Wang, C. M. Ryu, A. Kaundal, and K. S. Mysore, 2012. Glycolate Oxidase Modulates Reactive Oxygen Species-Mediated Signal Transduction during Nonhost Resistance in *Nicotiana benthamiana* and *Arabidopsis*", *Plant Cell*, **24(1)**: 336-352,
 35. Rao, V. S., K. Srinivas, G. N. Sujini, K. Sun, and G. N. Kumar, 2014. Protein-Protein Interaction Detection: Methods and Analysis. *Int. J. Proteom*, Article ID 147648, 12 pages, DOI: 10.1155/2014/147648



36. Ros Barceló, A., Morales, M. and Pedreño, M. A. 1998. Specific Compartmentalization of Peroxidase Isoenzymes in Relation to Lignin Biosynthesis in the Plant Cell. In: "Lignin and Lignan Biosynthesis", (Eds.): N.G. Lewis, N. G. and Sarkanen, S. American Chemical Society, Washington DC, PP. 84-95.
37. Szklarczyk, D., A. Franceschini, M. Kuhn, M. Simonovic, A. Roth A., Minguéz P., Doerks T., Stark M., Muller J., Bork P., Jensen L. J. and von Mering C. 2011. The STRING Database in 2011: Functional Interaction Networks of Proteins, Globally Integrated and Scored, *Nucleic Acids Res*, **39**: 561-568.
38. Santos I., H. Pires, J. M. Almeida, F. Fidalgo, A. Confraria, M. Duarte, J. Borlido, R. Salema, 2006. Phylogenetic Relationship of Potato CAT1 and CAT2 Genes, Their Differential Expression in Non-photosynthetic Organs and During Leaf Development, and Their Association with Different Cellular Processes. *Funct Plant Biol.*, **33(7)**: 639-651,
39. Szklarczyk, D., A. Franceschini, S. Wyder, K. Forslund, D. Heller, J. Huerta-Cepas, M. Simonovic, A. Roth, A. Santos, K. P. Tsafou, M. Kuhn, P. Bork, L. J. Jensen, and C. von Mering, 2015. STRING v10: Protein-protein Interaction Networks, Integrated over the Tree of Life, *Nucleic Acids Res.*, **43**:447-452.
40. Tohge, T., Watanabe, M., Hoefgen, R. and Fernie, A. R. 2013. Shikimate and Phenylalanine Biosynthesis in the Green Lineage, *Front Plant Sci.*, **4**: 1-13,
41. Torres, M. A., Jones, J. D. G. and J. L. Dang, J. L. 2006. Reactive Oxygen Species Signaling in Response to Pathogens. *Plant Physiol.*, **141(2)**: 373-378.
42. Touiserkani, T., R. Haddad, 2012. Cadmium-induced Stress and Antioxidative Responses in different *Brassica napus* cultivars", *J. Agr. Sci. Tech.*, **14**: 929-937.
43. Van de Peer, Y., and R. De Wachter, 1994. TREECON for Windows: a Software Package for the Construction and Drawing of Evolutionary Trees for the Microsoft Windows Environment, *Comput. Appl. Biosci.*, **10(5)**:569-570,
44. Willekens, H., C. Langebartels, C. Tire, M. Van Montagu, D. Inzé, and W. Van Camp, 1994. Differential Expression of Catalase Genes in *Nicotiana plumbaginifolia* (L.)". *Proc. Nat. Acad. Sci. USA*, **91(22)**:10450-10454,
45. Willekens, H., D. Inzé D, M. Van Montagu, and W. Van Camp, 1995. "Catalases in plants". *Molecular Breeding* **1**: 207-228,
46. Xie, D. W., X. N. Wang, L. S. Fu, J. Sun, W. Zheng, and Z. F. Li, 2015. Identification of the Trehalose-6-phosphate Synthase Gene Family in Winter Wheat and Expression Analysis under Conditions of Freezing Stress, *J. Genet.*, **94(1)**: 55-65.
47. Yu, B., Z. Jin, L. Deng, X. Xu, L. He, J. Wang, Y. Tian, and H. Chen, 2010. Kinetic Study of Thermal Inactivation of Potato Peroxidase during High-temperature Short-time Processing, *J. Food Sci. Technol.*, **47(1)**:67-72.

آنالیز شبکه برهمکنش و ارتباط فیلوژنتیکی پراکسیدازها و کاتالازهای سیب زمینی

پ. ظاهری

چکیده

پراکسیدازها (POXs) و کاتالازها (CATs) از آنزیمهای آنتی اکسیدان عمده دخیل در انهدام H_2O_2 در سلولهای زنده می باشند. انواع مختلف آنزیمهای POX و CAT ممکن است که دارای برهمکنش با اجزای سازنده سلول گیاهی باشند. با این که فعالیت آنزیم یا بیان ژن پراکسیدازها و کاتالازها در گیاهان سیب زمینی مورد بررسی قرار گرفته، برهمکنش آنها با سایر پروتئینها در این گیاه زراعی تاکنون ارزیابی نشده است. تعیین شبکه های برهمکنش پروتئین - پروتئین می تواند در ایجاد دیدگاه های مهمی در مورد نحوه تنظیم پاسخهای دفاعی گیاه به تنشهای ناشی از عوامل زنده و غیرزنده حائز اهمیت باشد. آنالیز STRING نشان داد که پراکسیدازهای کاتیونی، آنیونی مرتبط با تولید سوبرین و گروه سوم پراکسیدازها در سیب زمینی با آنزیمهای متعددی که در بیوسنتز لیگنین و مسیر فنیل پروپانوئید دخالت دارند، دارای برهمکنش می باشند که این یافته ها دارای تطابق با ارتباط فیلوژنتیکی نزدیک این سه پراکسیداز مورد بررسی در این پژوهش می باشند. آنزیم CAT1 در سیب زمینی دارای برهمکنش با چندین آنزیم دخیل در تولید گونه های فعال اکسیژن بود. آنالیز فیلوژنتیکی ژنهای CAT1 و CAT2 در این گونه گیاهی نشانگر ارتباط نزدیک آنها بود. به نظر می رسد که تعیین نحوه پاسخ هریک از این آنزیمها به محرکهای محیطی و برهمکنش آنها با سایر پروتئینها در سطوح رونویسی، ترجمه و فرایندهای پس از ترجمه، در طراحی استراتژی های نوین و موثر حفاظت گیاهان علیه تنشهای مختلف مفید می باشد.