

A Mathematical Model for Hydraulic Characterization of Microtube Emitters Using Dimensional Analysis

G. T. Katsurayama¹, L. R. Sobenko^{2*}, A. P. de Camargo³, T. A. Botrel², J. A. Frizzone², and S. N. Duarte²

ABSTRACT

A microtube emitter is a simple, low-cost emitter in which the length can be adjusted according to the distribution of pressures along an irrigation lateral line to deliver uniform discharge. To accurately design micro-irrigation systems using microtubes, it is necessary to use an equation that correlates hydraulic parameters, microtube characteristics, and fluid properties. Therefore, the objectives of this research were: (a) To develop an equation for design purposes using dimensional analysis by Buckingham's Pi theorem to represent the hydraulic processes in a microtube emitter operating in the laminar flow regime and (b) To compare the accuracy of the developed model against models that are currently used for microtube sizing. The data required to develop and validate the model was obtained experimentally in the laboratory by evaluating three types of microtubes with nominal diameters of 0.7, 0.8 and 1.0 mm. A model using pressure head, microtube length, flow rate, internal diameter, gravitational acceleration, and water properties was proposed and validated. The model for estimating hydraulic parameters in microtube emitters also presented better performance than other models available in the literature. Finally, an application example was presented and an irrigation lateral line using microtubes as emitters was designed using the proposed model.

Keywords: Buckingham's Pi theorem, Laminar flow, Micro-irrigation.

INTRODUCTION

Micro-irrigation systems are characterized by applying water with low flow rates for relatively long times with high frequency near the root zone through low operating pressure systems above or below ground level. These characteristics maintain a high level of moisture in a small volume of soil where the plant root system is usually contained. Based on this, microirrigation technologies are widely considered one of the most effective and efficient methods of irrigation (Keller and Bliesner, 1990).

In microirrigation system design, pressure differences at the emitters throughout the

subunit must be maintained in a range that enables achieving a target design emission uniformity (Frizzone *et al.*, 2012; ASAE, 2014). The lateral line length is calculated from the admissible flow rate variation in its extension, and the type of emitter has direct participation in this determination. Non-regulated drippers, despite allowing shorter lateral lines, can result in lower cost projects compared to regulated emitters due to the decrease in total annual costs for categories of similar operating pressures (Holzapfel *et al.*, 2007; Kumar *et al.*, 2015).

As an alternative to regulated emitters, microtube emitters, also called the "spaghetti tube", can be chosen. The

¹ Federal Institute of Education, Science, and Technology of Santa Catarina, Araquari, Santa Catarina, Brazil.

² Biosystems Engineering Department, College of Agriculture "Luiz de Queiroz", University of São Paulo, Piracicaba, São Paulo, Brazil.

³ University of Campinas, Agricultural Engineering College, Campinas, São Paulo, Brazil.

* Corresponding author; e-mail: luizsobenko@usp.br

microtube is a simple, low-cost emitter that was widely used throughout the world in the early days of drip irrigation (Almeida *et al.*, 2009). The microtube is a long-path emitter with an internal diameter typically ranging from 0.5–1.5 mm, with a flow exponent normally higher than 0.75. Since such emitters usually operate near the laminar flow regime, its discharge is prone to vary significantly due to pressure and temperature fluctuations; and these effects should be considered while designing laterals (Katsurayama *et al.*, 2017). Microtubes can also be applied as an extension for micro-sprinkler or micro-jet systems to increase the outlet pressure and, therefore, to cover larger areas (Keshtgar *et al.*, 2013).

Microtubes are commercially available in coils, which allow them to be obtained at any length. Therefore, their length can be adjusted according to the distribution of pressures along the lateral line to deliver a uniform discharge (Souza and Botrel, 2004; Almeida *et al.*, 2009). Theoretically, this allows all emitters to have the same flow rate and, therefore, near 100% uniformity in the lateral line. Therefore, in order to accurately design microirrigation systems with microtubes, it is necessary to use an equation that correlates the flow rate, length, inlet pressure at the microtube, internal diameter, and fluid properties.

Previous experimental investigations determined relationships for sizing microtube emitters in the laminar flow regime, i.e. Reynolds number less than 2000. Vermeiren and Jobling (1980) proposed an equation, in which the flow rate (Q) is a function of the operating pressure Head (H), the Length (L_m) and internal Diameter (D_{in}), as follows:

$$Q = \gamma_1 L_m^{\gamma_2} H^{\gamma_3} D_{in}^{\gamma_4} \quad (1)$$

Where, Q is the microtube flow rate ($L h^{-1}$), $\gamma_1, \gamma_2, \gamma_3$ and γ_4 are empirical coefficients (dimensionless), L_m is the microtube Length (m), H is the pressure Head (m), and D_{in} is the microtube internal Diameter (m).

Souza and Botrel (2004) used the Bernoulli equation applied between the inlet and outlet section of the microtube and associated the equations of friction and minor losses and kinetic energy in a single equation (Equation 2). Equation (2) is determined based on experiments using microtube emitters with nominal diameters ranging from 0.6–1.0 mm and considers the minor losses as a function of Reynolds number as well.

$$H = \frac{64 \nu^4}{\pi^2 2 g} \left(\frac{L_m Q}{D_{in}^4} \right) + \frac{16}{\pi^2 2 g} \left(\frac{Q^2}{D_{in}^4} \right) + \left[\alpha_K \ln(Re) + \beta_K \frac{16}{\pi^2 2 g} \left(\frac{Q^2}{D_{in}^4} \right) \right] \quad (2)$$

Where, ν is the water kinematic viscosity ($m^2 s^{-1}$), g is the gravitational acceleration ($m s^{-2}$), Re is the Reynolds number (dimensionless), and α_K and β_K are empirical coefficients which represent the minor loss coefficients as a function of Re (dimensionless).

The coefficients of these equations to design microtubes are usually tabulated according to their diameter. This means that values for intermediate diameters must be obtained by interpolation, which can lead to error because the values may not present linear variation. Emitters designed erroneously can lead to water application that differs from the design and, consequently, is lower than desired application uniformity, causing water stress in plants, either due to excess or deficit, and heterogeneity in the stand, hindering cultural treatment.

A model for estimating discharge of microtubes operating at any flow regime based on dimensional analysis was proposed and validated by Vekariya *et al.* (2010) (Equation 3).

$$Q = \left(\frac{20 D_{in}^5 H g}{L_m} \right)^{1/2} \quad (3)$$

Where, Q is the microtube flow rate ($cm^3 s^{-1}$), D_{in} is the microtube internal Diameter (cm), H is the pressure Head (cm), g is the gravitational acceleration ($cm s^{-2}$) and L_m is the microtube Length (cm).

Equation (3) is valid for microtubes with a nominal diameter ranging from 1.2–2.0 mm. According to Vekariya *et al.* (2010), that range is commonly used by drip manufacturers in India. In Brazil, microtubes for irrigation purposes are used mainly by small-holders (Souza *et al.*, 2009) and usually manufactured in nominal diameters varying from 0.7–1.0 mm. The equation proposed by Vekariya *et al.* (2010) might not be suitable for sizing microtubes with a nominal diameter smaller than 1.2 mm.

The objectives of this research were: (a) To develop an equation for design purposes based on dimensional analysis to represent the hydraulic processes inside a microtube emitter operating in the laminar flow regime; (b) To compare the accuracy of the developed model against models that are currently used for microtube sizing.

MATERIALS AND METHODS

The tests were performed at the Irrigation Testing Laboratory (LEMI) of the College of Agriculture “Luiz de Queiroz” (ESALQ/USP), Piracicaba, São Paulo State, Brazil. Three types of microtube emitters with Nominal Diameters (DN) of 0.7, 0.8 and 1.0 mm were evaluated. The emitters were made of low-density polyethylene with a 2.5 mm external diameter, and they were manufactured by Plasnova Inc. (Brazil).

Materials and Functional Tests

The first stage of tests aimed to determine the emitter D_{in} of the three types of microtubes using the hydraulic measurement model from the methodology described by Almeida and Botrel (2010). The water temperature was monitored using a temperature transmitter (accuracy 0.5°C). Water density (ρ) and water kinematic viscosity (ν) were estimated according to Equations (4) (Pinto *et al.*, 2014) and (5) (Kell, 1975), respectively. The nominal diameters 0.7, 0.8 and 1.0 mm presented the

following D_{in} : 0.79, 0.87 and 1.11 mm. According to Almeida and Botrel (2010), the experimental determination of D_{in} should be performed whenever possible by the designer for the correct sizing of microirrigation systems using microtubes, since it is a common problem in the Brazilian industry that the DN informed by the manufacturer presents deviations in relation to D_{in} , due to lack of quality control in the manufacturing processes. Almeida and Botrel (2010), Alves *et al.* (2012) and Katsurayama *et al.* (2017) identified, respectively, D_{in} deviations of up to 11.3, 10.3, and 5.6% in relation to the informed DN.

$$\rho = (999.8676 + 17.801161T - 7.942501 \times 10^{-3}T^2 - 52.56328 \times 10^{-6}T^3 + 137.6891 \times 10^{-9}T^4 - 364.4647 \times 10^{-12}T^5) / (1 + 17.735441 \times 10^{-3}T) \quad (4)$$

$$\nu = \frac{32.025666 \times 10^{-6}}{\rho} e^{\frac{482.134866}{T+119.886026}} \quad (5)$$

Where, ρ is the water density (kg m^{-3}) and T is the water Temperature ($^{\circ}\text{C}$).

In order to determine the pressure-discharge curves, 10 microtube samples were used for each D_{in} and L_m evaluated. The emitter lengths ranged from 0.3–1.5 m in 0.15 m increments. The spacing and insertion depth of the microtubes in the lateral line were standardized at 0.1 m and 5 mm, respectively. Polyethylene tubes with a 12.7 mm internal diameter were used as lateral lines.

The microtubes were evaluated under operating pressure heads ranging from 4.90–93.16 kPa in 9.81 kPa increments. During the tests, the operating pressure was controlled by two procedures: (a) For pressures lower than 30 kPa, the pressure head was provided by a suspended tank whose height was adjusted according to the required pressure; also, minor adjustments were made using a needle valve and monitored by a piezometer (Figure 1-a); and (b) For pressures higher than 30 kPa, the

tests were undertaken in a testing bench that consisted of a pump and an automated pressure control system equipped with a variable frequency drive and a Proportional-Integral-Derivative (PID) controller (Figure 1-b). The PID controller used a pressure transmitter (accuracy 0.1% of full scale; Full scale= 100 kPa), installed at the inlet of the lateral lines, to calculate the error between the pressure set point and the measured pressure and then apply an output signal to the Variable Frequency Drive (VFD).

During the tests, volumes of water were collected over a time interval that varied as a function of pressure. In addition, the time interval was constrained using 5 min as the minimum test time and 0.5 kg as the minimum water mass collected. Immediately after the test, the volume of water in each collector was weighed and converted into a flow rate.

The Coefficient of Variation of discharge (CV_Q) was calculated for a set of 10 emitters with the same D_{in} and L_m using Equation (6) and classified according to ASAE (2014). For this research, this coefficient

enables to quantify discharge variations due to internal diameter (manufacturing process) and length imperfections (segments were manually cut).

$$CV_Q = \frac{S_Q}{\bar{Q}} \quad (6)$$

Where, CV_Q is the Coefficient of Variation of discharge (dimensionless), S_Q is the Sample standard deviation ($L h^{-1}$), and \bar{Q} is the mean emitter discharge ($L h^{-1}$).

Model Development Procedure Using Dimensional Analysis

Dimensional analysis is a simple, clear, and intuitive method that is useful for solving fluid flow problems (Lemons, 2017). A combination of theoretical and experimental approaches is often required to develop practical solutions to problems in hydraulics and fluid mechanics (Zitterell et al., 2013; Vilaça et al., 2017; Sobenko et al., 2019). Dimensional analysis enables the reduction of physical quantities into dimensionless groups called Pi-terms (Π)

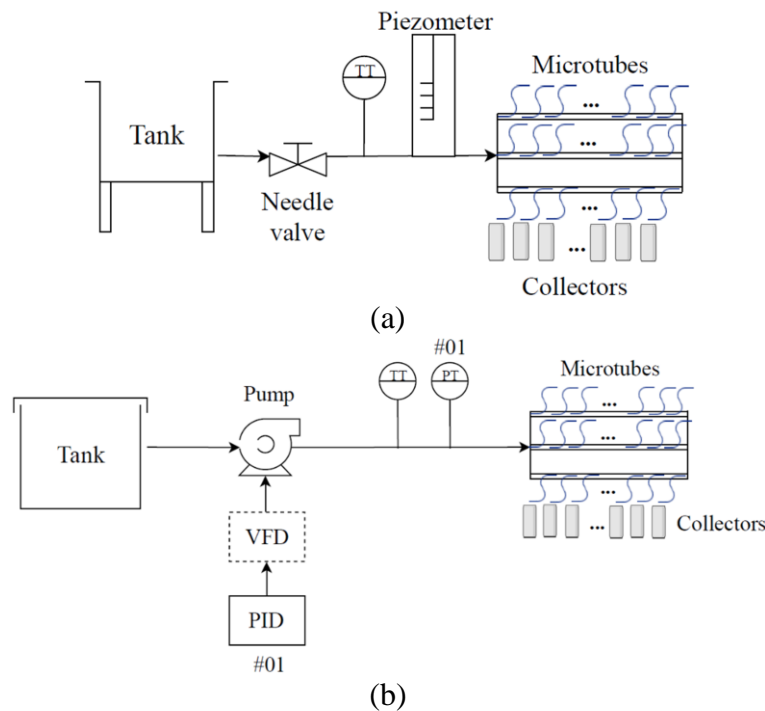

Figure 1. Instrumentation diagram of the testing benches used for functional microtube tests. TT: Temperature Transmitter and PT: Pressure Transmitter.

and is a useful tool for developing predictive equations (Vilaça *et al.*, 2017). In this research, the dimensional analysis was based on Buckingham’s Π theorem (Buckingham, 1914) and the method of repeating variables following practical procedures defined by Munson *et al.* (2009) and Fox *et al.* (2011).

Models based on dimensional analysis have been developed to estimate pressure losses and optimum lengths in drip irrigation laterals (Perboni *et al.*, 2015; Yurdem *et al.*, 2015), pressure loss in filters (Yurdem *et al.*, 2008; Duran-Ros *et al.*, 2010; Yurdem *et al.*, 2010, Wu *et al.*, 2014), minor losses in microirrigation connectors (Zitterell *et al.*, 2013; Vilaça *et al.*, 2017), energy losses in open channels (Gupta *et al.*, 2013; Helal *et al.*, 2018; Zayed *et al.*, 2018), injection rate in venturi injectors (Sobenko *et al.*, 2019) and to study the hydraulics of microtubes emitters (Vekariya *et al.*, 2010).

This theorem requires knowledge of the pertinent, nonredundant quantities affecting the physical system. The hydraulic processes in a microtube emitter are mainly influenced by its H , D_{in} , Q , L_m and fluid properties. In addition, to facilitate grouping of Π -terms, Q was expressed as flow velocity (v). For the model development, we assume that H is the dependent variable and, based on an empirical interpretation of this physical process, a mathematical relationship can be defined (Equation 7).

$$H = f(v, D_{in}, L_m, \rho, \mu) \tag{7}$$

Where, H is the pressure Head (Pa), v is the mean flow velocity ($m\ s^{-1}$), D_{in} is the microtube internal Diameter (m), L_m is the microtube Length (m), ρ is the water density ($kg\ m^{-3}$) and μ is the water dynamic viscosity (Pa s).

Lemons (2017) claimed that the number of variables necessary to represent a process should be minimized. Including unnecessary predictors in the model complicates the description of the process and may result in poor predictions, while omitting important effects reduces its predictive power (Chatterjee and Simonoff, 2013). A model should be as simple as possible while still

accounting for the important relationships in the data (Vilaça *et al.*, 2017).

The difference between the number of variables that describe a process (k) and the number of reference dimensions (r) required to define units in the list of variables results in the number of dimensionless groups (i.e., the Π -terms). In Equation (7) we can observe 6 variables ($k= 6$) associated with 3 reference dimensions ($r= 3$; Table 1). Therefore, the number of Pi-terms is equal to 3 (Equation 8).

$$\Pi_1 = \phi(\Pi_2, \Pi_3) \tag{8}$$

Where, Π_1, Π_2 , and Π_3 are the Pi-terms (dimensionless).

H was chosen as the dependent variable and the repeating variables were v , D_{in} and ρ . The repeating variables were systematically combined with the remaining variables to define the Π -terms. As a result of the derivation processes, the Π -terms were expressed as dimensionless terms:

$$\frac{H}{\rho v^2} = \phi\left(\frac{\rho v D_{in}}{\mu}, \frac{L_m}{D_{in}}\right) \tag{9}$$

A multivariate power-law model (Equation 10) was fit to the data using the Least Squares Method. This type of model has been employed successfully for modeling processes related to fluid flow in hydraulics and irrigation applications (Yurdem *et al.*, 2008; Vekariya *et al.*, 2010; Zitterel *et al.*, 2013; Perboni *et al.*, 2015; Vilaça *et al.*, 2017).

$$\Pi_1 = \beta_1 \Pi_2^{\beta_2} \Pi_3^{\beta_3} \tag{10}$$

Where, β_1, β_2 , and β_3 are empirical coefficients (dimensionless).

The dataset obtained experimentally was randomly divided into two subsets: (a) The calibrating dataset accounted for 70% of the experimental data and was used to fit the models; (b) The testing dataset consisted of the remaining 30% of the data and was used to validate the accuracy/performance of the model. Models were assessed using the Root Mean Square Error (RMSE) and by graphical error analysis with the objective of evaluating their accuracy to predict the following variables, H , Q and L_m . The RMSE is a common index to measure the

accuracy of models and quantifies differences between observed and estimated values (Duran-Ros *et al.*, 2010; Provenzano *et al.*, 2016). Graphical error analysis is also useful to quantify prediction errors associated with their frequency of occurrence (Vilaça *et al.*, 2017).

RESULTS AND DISCUSSION

Experimental Dataset

A dataset with 205 sets of Q as a function of H and L_m in the Laminar flow regime was obtained. The observed Q for various combinations of microtube length (0.30–1.50 m), nominal diameter (0.7, 0.8 and 1.0 mm) and operating pressure (4.90–93.16 kPa) are shown in Figure 2. The CV_Q ranged from 0.40–2.39%, with an average of $1.07 \pm 0.45\%$. Based on the CV_Q values, the microtube emitters could be classified as "excellent" according to the ASAE (2014).

Figure 2 shows emitter discharge as a function of microtube diameter, microtube length, and operating pressure. The emitter discharge showed the following expected trends: (a) It decreased with increasing microtube length; (b) It increased for larger microtube diameters; (c) It increased as the

pressure head was raised. These observations are theoretically expected, and they were also reported by Souza and Botrel (2004), Almeida *et al.* (2009), Vekariya *et al.* (2010) and Keshtgar *et al.* (2013).

The Prediction Model

The empirical coefficients of Equation (10) were fit using the calibration dataset, resulting in Equation (11).

$$\frac{H}{\rho v^2} = 14.8365 \left(\frac{\rho v D_{in}}{\mu} \right)^{-0.7906} \left(\frac{L_m}{D_{in}} \right)^{0.9408} \quad (11)$$

Expressing v as Q and re-arranging the terms in Equation (11), the proposed model is obtained:

$$H = 19.883 \rho^{0.2095} \mu^{0.7905} \frac{L_m^{0.9408} Q^{1.2095}}{D_{in}^{1.7314}} \quad (12)$$

Equation (12) is valid under certain constraints, $8.540 \times 10^{-4} \leq \mu \leq 9.518 \times 10^{-4}$ Pa s, $0.3 \leq L_m \leq 1.5$ m, $3.545 \times 10^{-8} \leq Q \leq 1.539 \times 10^{-6}$ m³ s⁻¹ and $7.96 \times 10^{-4} \leq D_{in} \leq 1.11 \times 10^{-3}$ m. Also, H and ρ are given in Pa and kg m⁻³, respectively.

The testing dataset also served to validate the proposed model and to compare its predictions against those obtained using the models developed by Souza and Botrel

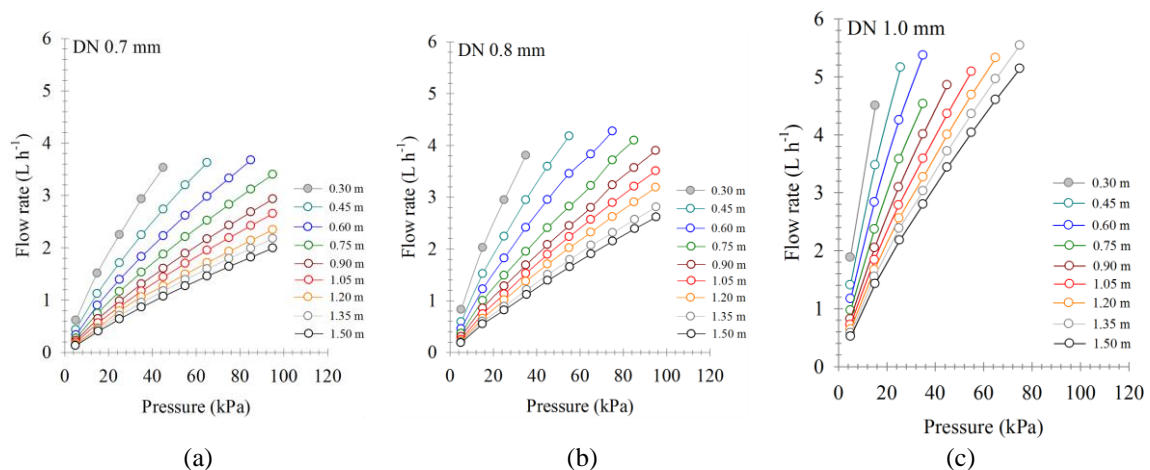

Figure 2. Experimental data of flow rate variation as a function of operating pressure in the laminar flow regime. Data obtained from testing 9 lengths (0.30–1.50 m) of 3 models of microtube emitters (DN 0.7, DN 0.8 and DN 1.0 mm).

(2004), Vermeiren and Jobling (1980) and Vekariya *et al.* (2010). For this, first, we isolate the variables “H”, “Q” and “L_m” of the 3 models and compare the estimated and observed data, as can be seen in Figures 3, 4 and 5, respectively.

Interpretation of the results shown in Figure 3 leads to the following observations: (a) Equation (1)- Proposed by Vermeiren and Jobling (1980), underestimated the values of H (Figure 3-c); (b) Equation (3)-Proposed by Vekariya *et al.* (2010), overestimated 70.1% of the H values (Figure 3-c); (c) A comparison of RMSE values for predicting H indicates Higher accuracy for the proposed model, with RMSE values from Souza and Botrel’s (2004), Vermeiren and Jobling’s (1980), and Vekariya *et al.*’s (2010) models being higher by 3.1, 6.8 and 26.7 times, respectively; (d) The graphical error analysis (Figure 3-e) demonstrates that the proposed model presents lower relative errors (δ) that also occur less frequently

compared to the three literature models. The importance of Figure 3-e can be clearly understood from the examples presented in Table 1, which shows that 95% of H predictions using the proposed model presented relative errors of up to 11.7%, while relative errors reached 52.9, 27.7 and 90.8% for the models proposed in Equations (1), (2) and (3), respectively.

For predicting Q, the proposed model also presented good performance, with a lower RMSE than the other models evaluated (Figure 4). From the scattering data presented in Figure 4-b, it is possible to observe that for Q higher than 3 L h⁻¹, the model proposed by Souza and Botrel (2004) could not fit the testing dataset. On the other hand, the model proposed by Vermeiren and Jobling (1980) tended to overestimate all predicted Q values (Figure 4-c). Figure 4e and Table 1 show that 95% of Q predictions using the proposed model presented relative errors of up to 13.3%, while relative errors

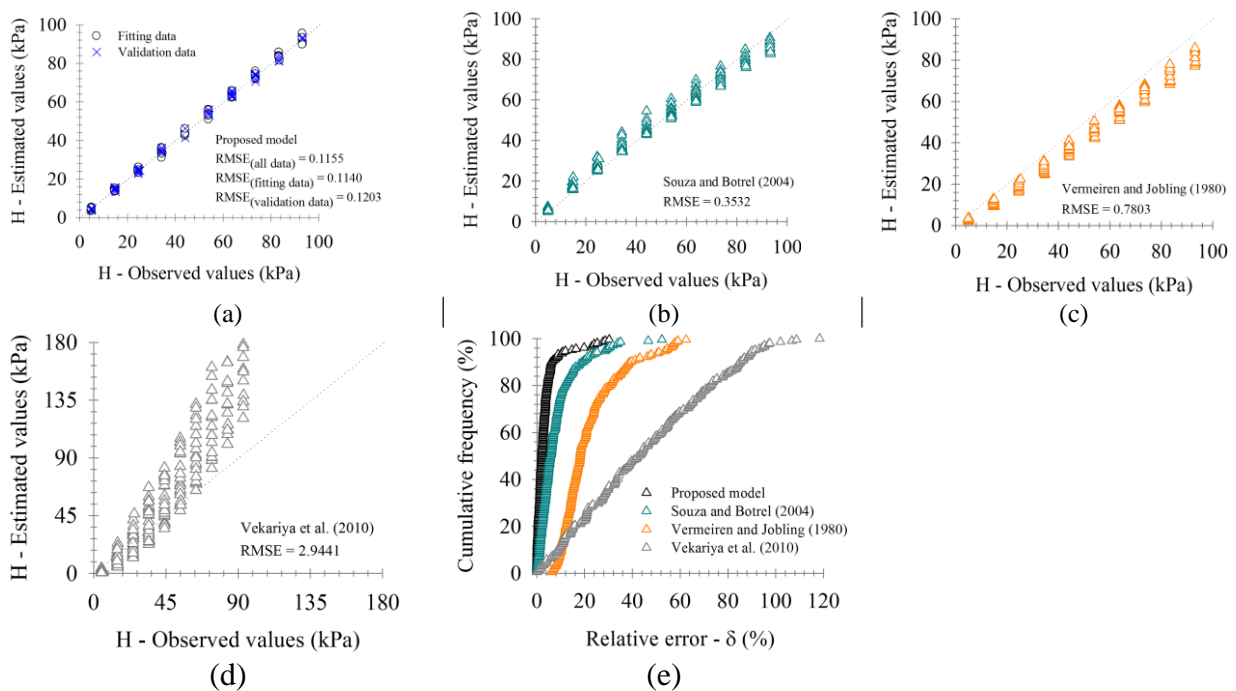

Figure 3. Comparison between the proposed model (Equation 12) and Equations (1), (2) and (3), for predicting the operating pressure Head (H) in microtube emitters. (a), (b), (c) and (d) observed versus estimated values of H using the models, and (e) graphical error analysis presenting relative errors (δ) versus frequency of errors in predictions of H ($\delta = 100 \left| \frac{\text{observed} - \text{estimated}}{\text{observed}} \right|$).

Table 1. Error analysis interpretation for the evaluated models for the prediction of operating pressure Head (H), flow rate (Q) and microtube Length (L_m).

Estimated variable	Model	Frequency occurrence: Relative error (δ)
H	Proposed	95% : $\delta \leq 11.7\%$
	Souza and Botrel (2004)	95% : $\delta \leq 27.4\%$
	Vermeiren and Jobling (1980)	95% : $\delta \leq 52.9\%$
	Vekariya et al. (2010)	95% : $\delta \leq 90.8\%$
Q	Proposed	95% : $\delta \leq 13.3\%$
	Souza and Botrel (2004)	95% : $\delta \leq 18.5\%$
	Vermeiren and Jobling (1980)	95% : $\delta \leq 69.6\%$
	Vekariya et al. (2010)	95% : $\delta \leq 164\%$
L_m	Proposed	95% : $\delta \leq 6.2\%$
	Souza and Botrel (2004)	95% : $\delta \leq 38.4\%$
	Vermeiren and Jobling (1980)	95% : $\delta \leq 132\%$
	Vekariya et al. (2010)	95% : $\delta \leq 265\%$

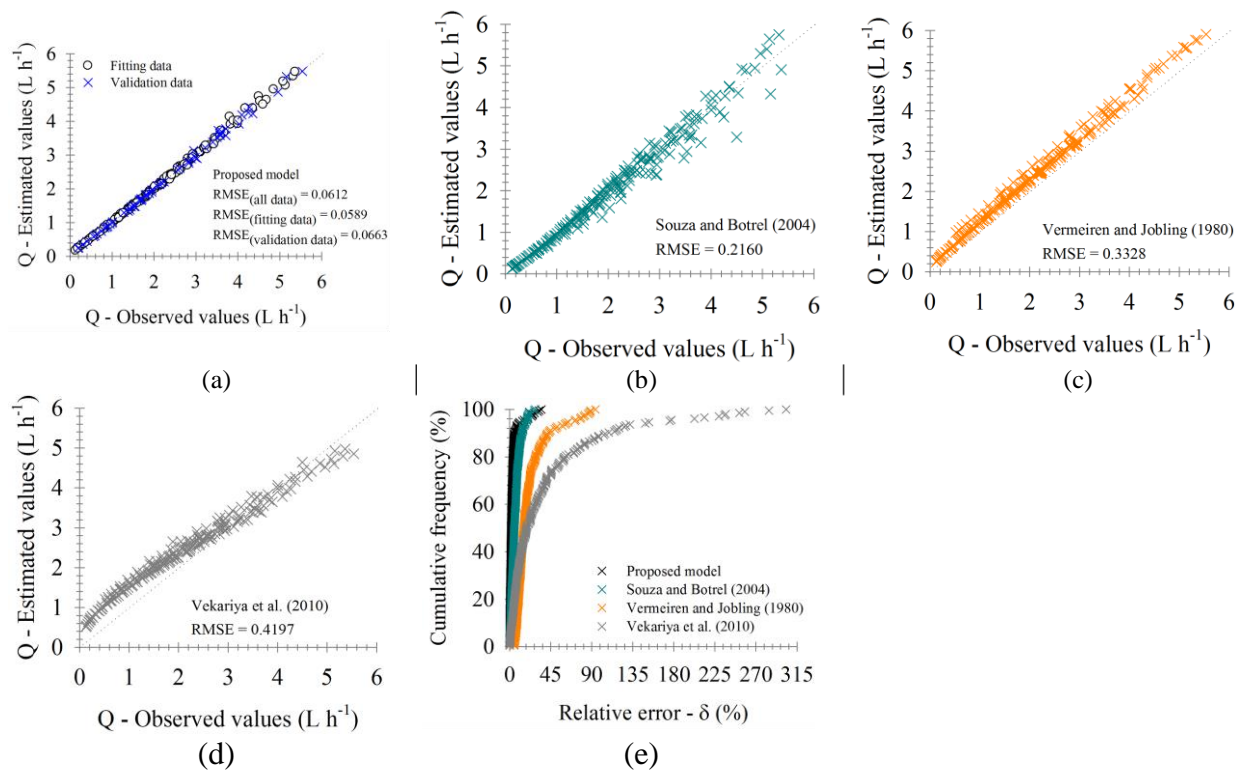

Figure 4. Comparison between the proposed model (Equation 12) and Equations (1), (2) and (3) for predicting the flow rate (Q) in microtube emitters. (a), (b), (c) and (d) observed versus estimated values of Q from the models; and (e) graphical error analysis presenting relative errors (δ) versus frequency of errors in predictions of Q.

reached 69.6, 18.5 and 164% using the models proposed in Equations (1), (2) and (3), respectively.

For L_m prediction from a given H and Q , the proposed model also presented the best performance, with a lower RMSE than the other models evaluated (Figure 5). Table 1 and Figure 5-e show that 95% of L_m predictions using the proposed model presented relative errors of up to 6.2%, while the relative errors reached 132, 38.4 and 265% for the models proposed in Equations (1), (2) and (3), respectively.

As already mentioned, the Souza and Botrel (2004) and Vermeiren and Jobling (1980) model coefficients were tabulated and it was necessary to perform interpolations to obtain them. However, the variations in these coefficients are not linear, which may impair the accuracy of the model. In order to explain this, first, the

coefficient K from the Souza and Botrel (2004) model was isolated, which represents the minor losses by the terms “ $\alpha_K \ln(Re) + \beta_K$ ” from Equation (2). K was then plotted as a function of the Reynolds number of the testing dataset (Figure 6). From Figure 6, the scattering and values of K tend to decrease as Re increases, which corroborate the results reported by Juana *et al.* (2002) and Flores *et al.* (2017).

Secondly, the model proposed by Vermeiren and Jobling (1980) does not use u in its equation, i.e. does not consider the variation of the water temperature. Microtube emitters operating in the laminar flow regime are highly sensitive to variations in temperature and pressure (Katsurayama *et al.*, 2017), as well as greater risks of clogging (Souza and Botrel, 2004). This also explains the better performance of Souza and Botrel’s (2004)

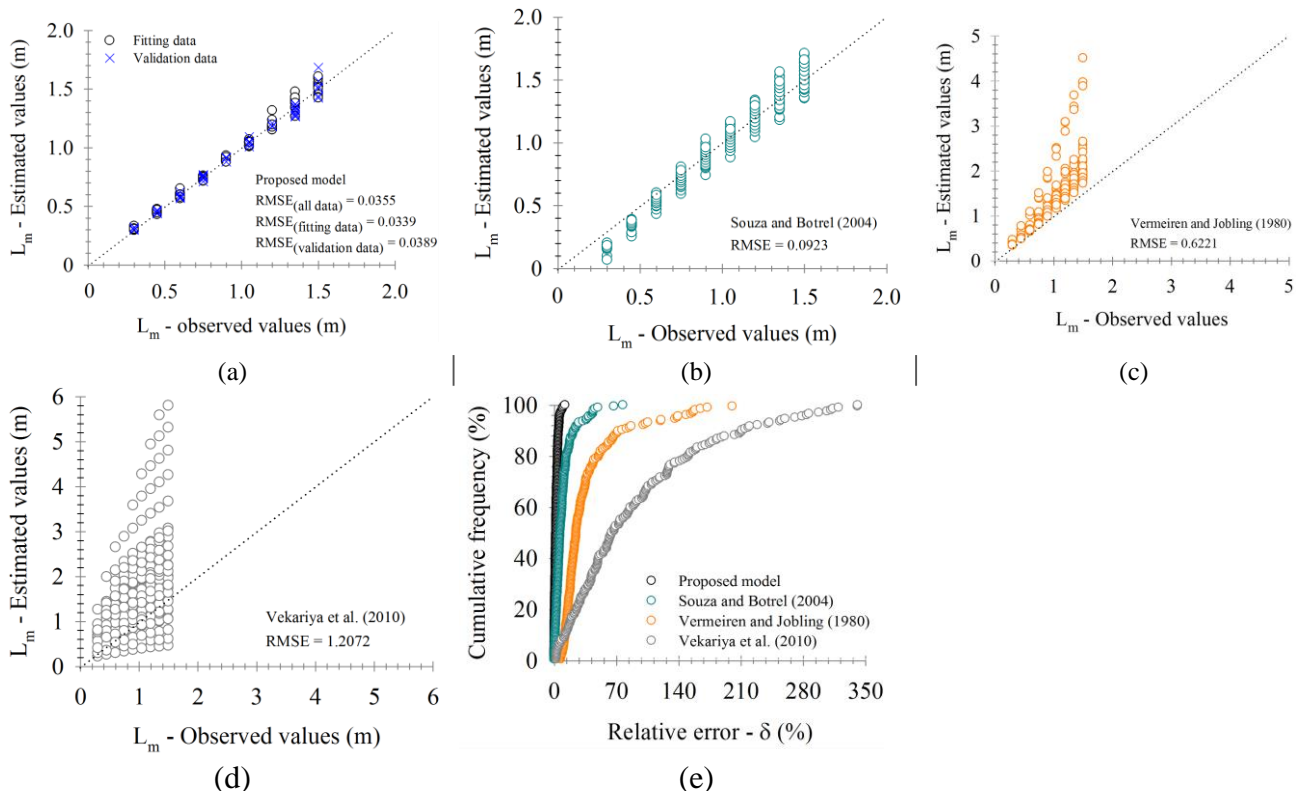

Figure 5. Comparison between the proposed model (Equation 12) and Equations (1), (2) and (3) for predicting the microtube length (L_m). (a), (b), (c) and (d) observed versus estimated values of L_m from the models; and (e) graphical error analysis presenting relative errors (δ) versus frequency of errors in predictions of L_m .

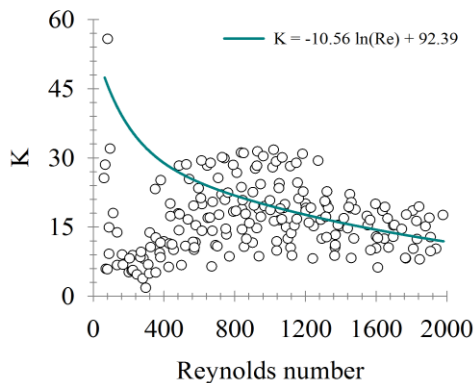

Figure 6. Coefficient K of minor losses for the model proposed by Souza and Botrel (2004) as a function of Reynolds number.

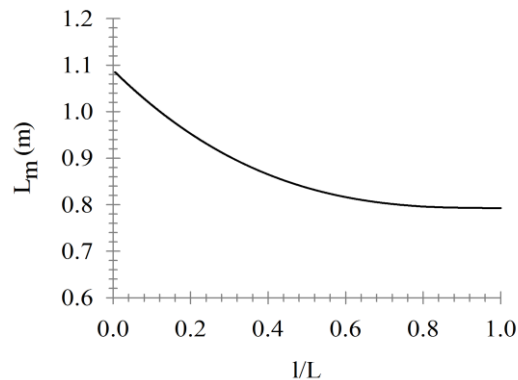

Figure 7. Microtube Length (L_m) along the lateral line, expressed in terms of relative length (l/L).

model compared to Vermeiren and Jobling's (1980) model since there is also a theoretical deduction for the first model.

Regarding the Vekariya *et al.* (2010) model, the results confirmed the hypothesis that this model is not applicable for sizing microtubes with nominal diameters smaller than 1.2 mm in the laminar flow regime. Therefore, the proposed model complements the results of Vekariya *et al.* (2010) and it enables accurate estimation of hydraulics variables for smaller microtubes.

Application example

Usually, the design of microtubes is done by calculating the L_m for a given Q , H and head loss condition (Frizzone *et al.*, 2012). In order to demonstrate the use of the proposed model, let's suppose the design of an irrigation lateral line using the step-by-step method. The lateral is 100 m long with a 12.7 mm internal diameter and emitting points spaced 0.5 m. The average flow rate of the microtubes is 2 L h^{-1} and the pressure head at the last emission point is 100 kPa. The internal diameter of the available microtube is 0.7 mm, and laminar flow regime (i.e., $Re < 2000$) in all emitters along the lateral is mandatory.

First, we must calculate the head loss between two consecutive emitters of the

lateral line using the Darcy-Weisbach equation, considering the coefficient of friction calculated by the Blasius equation. This procedure allows to obtain the pressure values at the inlet of each emission point, and, by accumulating this head loss along the lateral line, a value of 134.4 kPa is obtained at the lateral line inlet.

By applying Equation (12), rearranged with the explicit term L_m , the length of each microtube for the lateral line will be obtained (Figure 7). As can be observed in Figure 7, microtubes length range from 0.79 to 1.09 m along the lateral line to provide $Q = 2 \text{ L h}^{-1}$. It is assumed that the water dynamic viscosity is $1.003 \times 10^{-3} \text{ Pa s}$ and its density is 1000 kg m^{-3} .

CONCLUSIONS

1. Based on dimensional analysis, a model was developed for sizing microtube emitters operating in the laminar flow regime as a function of pressure Head (H), microtube Length (L_m), flow rate (Q), internal Diameter (D_{in}), gravitational acceleration (g), and water properties;

2. The proposed model for estimating hydraulic parameters in microtube emitters presented better performance than other models available in the literature;

3. The model proposed by Vekariya *et al.* (2010) does not properly estimate flow parameters of microtubes with internal diameters less than 1.2 mm,

4. An example application was presented and an irrigation lateral line using microtube emitters was sized using the proposed model.

ACKNOWLEDGEMENTS

The authors are grateful to the following Brazilian institutions for their financial support: the Federal Department of Science and Technology (MCT), the National Scientific and Technological Development Council (CNPq), the São Paulo State Scientific Foundation (FAPESP) and the National Institute of Science and Technology in Irrigation Engineering (INCTEI).

REFERENCES

- Almeida, C. D. G. C., Botrel, T. A. and Smith, R. J. 2009. Characterization of the Microtube Emitters Used in a Novel Micro-Sprinkler. *Irrig. Sci.*, **27**: 209–214.
- Almeida, C. D. G. C. and Botrel, T. A., 2010. Microtubes Diameter Determination in Trickle Irrigation. *Rev. Bras. Ciênc. Agrár.*, **5**: 413–417. (Abstract in English)
- Alves, D. G., Pinto, M. F., Salvador, C. A., Almeida, A. C. S., Almeida, C. D. G. C. and Botrel, T. A. 2012. Modeling for the Design of Micro-Irrigation System Using Branched Microtubes [Abstract in English]. *Rev. Bras. Eng. Agríc. Ambiental*, **16**(2): 125-132.
- American Society for Agricultural Engineering-ASAE EP405.1 APR1988 (R2014). 2014. *Design and Installation of Microirrigation Systems*. ASABE, St. Joseph, MI, 5 PP.
- Buckingham, E. 1914. On Physically Similar Systems: Illustrations of the Use of Dimensional Equations. *Phys. Rev.*, **4**: 345–376.
- Chatterjee, S. and Simonoff, J. 2013. *Handbook of Regression Analysis*. Wiley, Hoboken.
- Duran-Ros, M., Arbat, G., Barragán, J., Ramírez de Cartagena, F. and Puig-Bargués, J. 2010. Assessment of Head Loss Equations Developed with Dimensional Analysis for Micro Irrigation Filters Using Effluents. *Biosyst. Eng.*, **106**: 521–526.
- Flores, J. H. N., Rettore Neto, O., Faria, L. C. and Timm, L. C. 2017. Estimation of the Kinetic Head Coefficient (k) Based on the Geometric Characteristics of Emitter Pipes. *Eng. Agríc.*, **37**(6): 1091–1102.
- Fox, R. W., McDonald, A. T. and Pritchard, P. J. 2011. *Introduction to Fluid Mechanics*. 8 Edition, IE-Wiley, Hoboken.
- Frizzone, J. A., Freitas, P. S. L. de, Rezende, R. and Faria, M. A. de. 2012. *Microirrigação: Gotejamento e Microaspersão*. Maringá, Eduem.
- Gupta, S. K., Mehta, R. C. and Dwivedi, V. K. 2013. Modeling of Relative Energy Loss of Free Hydraulic Jump in Horizontal Prismatic Channel. *Procedia Eng.*, **51**: 529–537.
- Helal, E., Sobeih, M. and El-din, M. E. 2018. Effect of Floating Bridges on Open Channels' Flow and Bed Morphology. *J. Irrig. Drain. Eng.*, **144**(9): 04018026.
- Holzappel, E. A., Abarca, W. A., Paz, V. P. S., Arumi, J. L., Rodriguez, A., Orrego, X. and Lopez, M. A. 2007. Selección Técnico-Economica de Emissores. *Rev. Bras. Eng. Agríc. Ambiental*, **11**(6): 547–556.
- Juana, L., Rodrigues-Sinobas, L. and Losada, A. 2002. Determining Minor Head Losses in Drip Irrigation Laterals. I: Methodology. *J. Irrig. Drain. Eng.*, **128**(6): 376–384.
- Katsurayama, G. T., Saretta, E., Camargo, A. P., Botrel, T.A. and Salvador, C. A. 2017. Methodology for Designing Lateral Lines with Microtubes Operated under Variable Inlet Pressure. *Rev. Bras. Eng. Agríc. Ambiental*, **21**: 594–599.
- Kell, G. S. 1975. Density, Thermal Expansivity, and Compressibility of Liquid Water from 0 to 150°C. *J. Chem. Eng. Data*, **20**: 97–105.
- Keller, J. and Bliesner, R. D. 1990. *Sprinkler and Trickle Irrigation*. Chapman and Hall, New York.
- Keshtgar, A., Bhuiyan, M. A. and Jayasuriya, N. 2013. Design of Drip Irrigation System Using Microtubes for Full Emission Uniformity. *Irrig. Drain.*, **62**: 613–623.

20. Kumar, M., Reddy, K. S., Adake, R. V. and Rao, C. V. K. N. 2015. Solar Powered Micro-Irrigation System for Small Holders of Dryland Agriculture in India. *Agric. Water Manage.*, **158**: 112–119.
21. Lemons, D. S. 2017. *A Student's Guide to Dimensional Analysis*. Cambridge University Press, New York.
22. Munson, B. R., Yong, D. F., Okiishi, T. H. and Huebsch, W. W. 2009. *Fundamentals of Fluid Mechanics*. 7 Edition, IE-Wiley, Hoboken.
23. Perboni, A., Frizzone J. A., Camargo, A. P. and Pinto, M. F. 2015. Modelling Head Loss along Emitting Pipes Using Dimensional Analysis. *J. Braz. Assoc. Agric. Eng.*, **35**: 442–457.
24. Pinto, M. F., Camargo, A. P., Rettore Neto, O. and Frizzone, J. A. 2014. Hydraulic Characterization of Porous Pipes Made of Recycled Automobile Tires Used in Subsurface Irrigation. *Rev. Bras. Eng. Agríc. Ambiental*, **18**: 1095–1101. (Abstract in English)
25. Provenzano, G. P., Alagna, V., Autovino, D. and Juarez, J. M. 2016. Analysis of Geometrical Relationships and Friction Losses in Small-Diameter Lay-Flat Polyethylene Pipes. *J. Irrig. Drain. Eng.*, **142**: 1–9.
26. Sobenko, L. R., Frizzone, J. A., Camargo, A. P., Saretta, E. and Rocha, H. S. 2019. Characterization of Venturi Injector Using Dimensional Analysis. *Rev. Bras. Eng. Agríc. Ambiental*, **23(7)**: 484–491.
27. Souza, R. O. R. M. and Botrel, T. A. 2004. Modeling for the Design of Microtubes in Trickle Irrigation. *Rev. Bras. Eng. Agríc. Ambiental*, **8(1)**: 16–22. (Abstract in English)
28. Souza, R. O. R. M., Miranda, E. P., Nascimento Neto, J. R., Ferreira, T. T. S. and Mesquita, F. P. 2009. Gravity Drip Irrigation in Agricultural Communities of Ceará. *Rev. Ciênc. Agron.*, **40(1)**: 34–40. (Abstract in English)
29. Vekariya, P. B., Subbaiah, R. and Mashru, H. H. 2010. Hydraulics of Microtube Emitters: A Dimensional Analysis Approach. *Irrig. Sci.*, **29**: 341–350.
30. Vermeiren, L. and Jobling, G. A. 1980. *Localized Irrigation: Design, Installation, Operation, and Evaluation*. FAO, Rome.
31. Vilaça, F. N., Camargo, A. P., Frizzone, J. A., Mateos, L. and Koech, R. 2017. Minor Losses in Start Connectors of Microirrigation Laterals. *Irrig. Sci.*, **35**: 227–240.
32. Wu, W., Chen, W.E.I., Liu, H., Yin, S. and Niu, Y. 2014. A New Model for Head Loss Assessment of Screen Filters Developed with Dimensional Analysis in Drip Irrigation Systems. *Irrig. Drain.*, **63**: 523–531.
33. Yurdem, H., Demir, V. and Degirmencioglu, A. 2008. Development of a Mathematical Model to Predict Head Losses from Disc Filters in Drip Irrigation Systems Using Dimensional Analysis. *Biosyst. Eng.*, **100**: 14–23.
34. Yurdem H., Demir, V. and Degirmencioglu, A. 2010. Development of a Mathematical Model to Predict Clean Water Head Losses in Hydrocyclone Filters in Drip Irrigation Systems Using Dimensional Analysis. *Biosyst. Eng.*, **105**: 495–506.
35. Yurdem, H., Demir, V. and Mancuhan, A. 2015. Development of a Simplified Model for Predicting the Optimum Lengths of Drip Irrigation Laterals with Coextruded Cylindrical in-Line Emitters. *Biosyst. Eng.*, **137**: 22–35.
36. Zayed, M., El Molla, A. and Sallah, M. 2018. An Experimental Investigation of Head Loss through a Triangular “V-Shaped” Screen. *J. Adv. Res.*, **10**: 69–76.
37. Zitterell, D. B., Frizzone, J. A. and Rettore Neto, O. 2013. Dimensional Analysis Approach to Estimate Local Head Losses in Microirrigation Connectors. *Irrig. Sci.*, **32**: 169–179.

یک مدل ریاضی برای مشخص کردن ویژگی های هیدرولیکی ریزلوله قطره چکان (میکرو تیوب) با استفاده از تجزیه تحلیل ابعادی

گ.ت. کاتسورایاما، ل.ر. سوبنکو، ا.پ. دکامارگو، ت.ا. بوتزل، ج.ا. فریزون، و س.ن. دوارت

چکیده

ریزلوله قطره چکان (میکرو تیوب)، قطره چکان ساده و ارزانی است که در آن طول ریزلوله را می توان مطابق با توزیع فشار در طول لوله لترال آبیاری تنظیم کرد تا دبی یکنواختی داشته باشد. برای طراحی درست سامانه ریز آبیاری (micro-irrigation)، لازم است از معادله ای استفاده کرد که پارامترهای هیدرولیکی، ویژگی های ریزلوله، و خصوصیات ماده سیال (آب) را به هم ارتباط می دهد. بنا بر این، اهداف این پژوهش عبارت بود از (۱) بر پا ساختن معادله ای برای منظورهای طراحی با استفاده از تحلیل ابعادی (dimensional analysis) مطابق نظریه Buckingham برای نشان دادن فرایند های هیدرولیکی در یک ریزلوله قطره چکان در یک رژیم با جریان ورقه ای و (۲) مقایسه صحت نتایج این مدل ساخته شده با مدل هایی که اکنون برای تعیین اندازه ریزلوله ها به کار می روند. در این رابطه، با انجام آزمون در یک آزمایشگاه و ارزیابی سه نوع ریزلوله با قطرهای اسمی برابر ۰/۷، ۰/۸، و ۱/۰ میلی متر، داده های مورد نیاز برای برپا سازی مدل و صحت سنجی آن به دست آمد. سپس، مدلی با استفاده از بار فشاری، طول ریزلوله، نرخ جریان، قطر داخلی لوله، شتاب ثقلی، و ویژگی های آب بر پا شد و صحت سنجی گردید. مدل برآورد پارامترهای هیدرولیکی در ریزلوله قطره چکان، عملکرد بهتری از دیگر مدل های موجود در منابع علمی نشان داد. بالاخره اینکه، یک مثال کاربردی ارائه شد و با کار بست مدل مزبور، یک خط لوله لترال آبیاری که از ریزلوله ها به عنوان قطره چکان استفاده می کرد طراحی شد.