

The Full Length Hepatitis C Virus Polyprotein and Interactions with the Interferon-Beta Signalling Pathways *in vitro*

Masoud Sabouri Ghannad^{*1} and Alireza Zamani²

¹Dept. of Microbiology and ²Dept. of Hematology and Immunology, School of Medicine, Hamadan University of Medical Sciences, Hamadan 65178-3-8736, Iran

Received 26 December 2007; revised 29 May 2007; accepted 12 June 2007

ABSTRACT

Background: Hepatitis C is a global health problem. The exact mechanisms by which hepatitis C virus (HCV) can evade the host immune system have become controversial. Whether HCV polyproteins modulate IFN signalling pathways or HCV proteins are responsible for such a property is the subject of interest. Therefore, an efficient baculovirus delivery system was developed to introduce the whole genome of HCV1B minus 3' untranslated region (UTR) (HCV1BΔ3'UTR) into hepatoma cells. **Methods:** The whole genome of HCV genotype 1b was developed into hepatoma cells. Also, two replicon constructs were used in this research: a recombinant baculovirus containing the culture adapted sub-genomic replicon (FK5.1) derived from HCV genotype 1b, and a mutant form containing an inactivating mutation within the non-structural protein 5B (NS5B). **Results:** As expected, the baculovirus carrying the FK5.1 replicon induced the production of IFN-β as judged by the use of an IFN-β promoter luciferase reporter construct, whereas the GND baculovirus (a control polymerase knock-out replicon) and the full-length 3'UTR deletant failed to induce luciferase expression. The activation of both IFN regulatory factor 3 (IRF3) and nuclear factor κB (NFκB), two transcription factors induced by dsRNA signalling were examined. Both the wild type and GND-mutant replicon blocked the dsRNA-induced activation of IRF3 and NFκB. **Conclusion:** Inhibition of the transcriptional response to IRF3 and NFκB seems to be one of the multiple mechanisms which HCV employs to escape the host immune defence. In contrast, the full length 3'UTR deletant had no significant effect on either transcription factor. These results may be attributed to the function of HCV subgenomic replicons when compared with full length 3'UTR deletant. *Iran. Biomed. J. 12 (1): 23-34, 2008*

Keywords: Hepatitis C virus (HCV), IFN-β, IFN regulatory factor 3 (IRF3), Nuclear factor κB (NFκB)

INTRODUCTION

Hepatitis C is a global health problem with 170 million carriers in the world that 3 to 4 million are newly infected annually [1]. The hepatitis C virus (HCV) epidemic has been known as the silent epidemic. In 20% of patients, chronic HCV infection develops to liver cirrhosis [2]. Furthermore, the risk of occurrence of hepatocellular carcinoma has been reported about 80% in patients suffering from cirrhosis [3].

Establishing the HCV replicons as subgenomic and self-replicating RNA molecules has partially fulfilled the need for a cell culture model capable to support HCV replication. HCV replicons potentially

capable to replicate in human hepatoma cell lines produces the non-structural NS2, NS3, NS4A, NS4B, NS5A and NS5B or NS3, NS4A, NS4B, NS5A and NS5B proteins. Wakita *et al.* [4] showed full length Japan fulminant hepatitis produces infectious HCV in tissue culture, but in spite of such progress and the establishment of HCV subgenomic replicons, there are still several important questions that remain unanswered. IFN therapy fails in about 50% of infected people with genotype 1 [5]. It has been clear that 1A and 1B are more resistant to IFN therapy than other HCV subtypes.

HCV utilizes multiple mechanisms to persist in the face of the immune system. Different mechanisms

*Corresponding Author; Tel. (+98-811) 8276 295-8 Ext. 138; Fax: (+98-811) 8276 299; E-mail: sabouri39@yahoo.com

have been considered to be involved in the activation of IFN- β and subsequent cellular genes. Also, the possible effects of HCV proteins on the IFN- β signalling pathway have remained far from complete or clear.

Establishment of HCV subgenomic replicons (self-replicating RNA molecules) constructed from genotype 1B has provided important information about HCV non-structural proteins [6]. However, more information about molecular interactions between HCV with cell signalling is required to clarify details of the pathogenesis and persistence of the virus. At the time this research was initiated, no cell culture system or small animal model had been reported that was capable of supporting HCV replication [6, 7].

The main aim of this research was to investigate the modulation of IFN- β signalling by the complete HCV polyproteins in more detail. An efficient baculovirus delivery system was developed to introduce the whole genome of HCV1B Δ 3' untranslated region (UTR) into hepatoma cells. A complicating factor in this analysis was the ability of the full length HCV to undergo RNA replication thus, generating dsRNA inducing an IFN- β response. To circumvent this and allow the study of effects of HCV proteins on IFN- β signalling, a construct lacking the 3'UTR was generated. This system also allowed for regulation of HCV polyprotein expression under the control of a tetracycline responsive promoter.

Moreover, the effect of HCV competent culture adapted replicon and also a polymerase-defective replicon on the induction and inhibition of IFN- β signalling pathway were analysed. Taken together these data may shed light on the mechanism by which HCV escapes the immune system.

MATERIALS AND METHODS

Generation of DNA constructs. Baculovirus containing J4 Δ 3'UTR was generated and the structure was amplified at several stages. In the first instance, the whole ORF sequences of HCV1b (J4) complementary DNA was cloned into the pBac Δ H77(HDV)Tet construct containing the 5'UTR and 3'UTR of H77 (complementary DNA of HCV1a) which donated kindly by Dr. McCormick (University of Leeds, Leeds, U.K.) (Figs. 1 and 2). In the next stage, 3'UTR of pBacJ4(HDV)Tet was deleted using Rec A protein and a specific oligonucleotide homologous sequence (5'-GCC

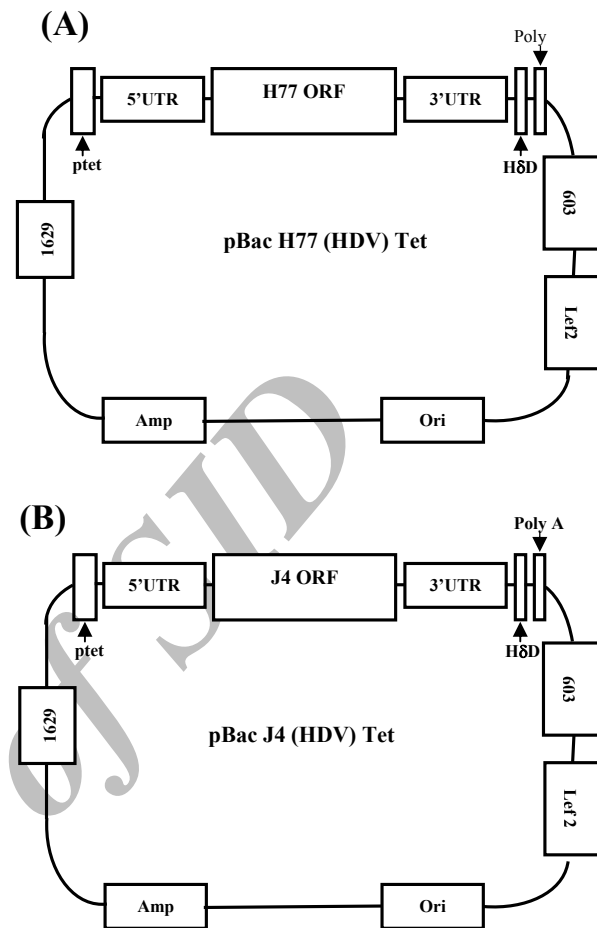

Fig. 1. The schematic of structures of pBac H77 (HDV) Tet and pBac J4 (HDV) Tet. **(A)**, The schematic of a pBacMam-2 ampicillin resistance vector containing the whole genome of HCV1a (H77) donated by Dr. Christopher McCormick (University of Leeds, Leeds, U.K.). This construct contained an inducible tetracycline promoter (ptet) which was coupled to the 5'UTR. Also, a hepatitis delta virus ribozyme was located upstream of poly A which enabled cleavage of the poly A tail before the protein translation process. Lef2, 603, 1629 are open reading frames flanking baculovirus sequences to permit generation of recombinant baculoviruses by homologous recombination. This construct carries two segments of the AcNPV genomic DNA (ORF 603 and ORF 1629), multiple cloning site and transcription terminator sequences. The presence of the Lef2 open reading frame is not essential for homologous recombination but it is involved in the recombination process. Ori is the replication origin which is a sequence of DNA at which replication is started. Amp refers to an ampicillin resistant gene; **(B)**, The schematic of a pBacMam-2 ampicillin resistance vector containing the whole genome of HCV1b (J4).

TGC ACC TGA TGA GGA GTG AAT TCC
GTC CCA TTC-3') to the site of interest (Fig. 3).

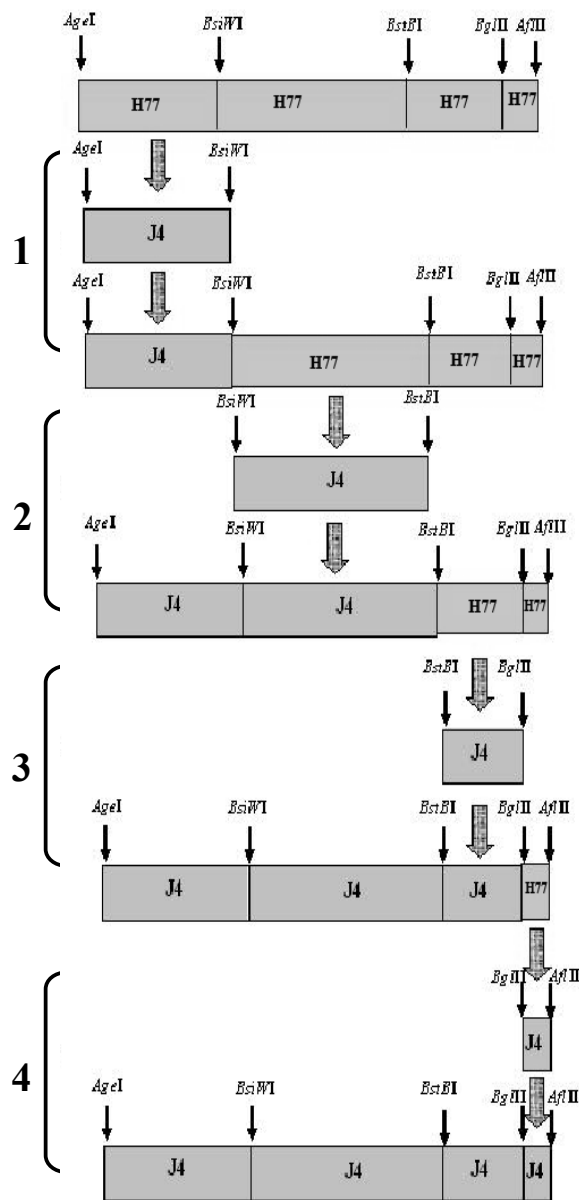

Fig. 2. Diagram of strategy for cloning the J4 open reading frame sequences into the pBacH77(HDV)Tet. HCV cDNA 1a (H77) was cut out from pBacH77(HDV)Tet by using *AgeI* and *AflII* restriction enzymes. A specific oligonucleotide containing restriction site targets for *AgeI*, *BsiWI*, *BstBI*, *BglII* and *AflII* restriction enzymes was cloned into pBac Δ H77 (HDV)Tet. The chimeric HCV cDNA with the J4 sequence (pCV-J4L6S) containing the whole open reading frame of HCV genotype 1b strain (HC-J4) and a HCV cassette vector (pCV) was used in present experiment. Both pBac Δ H77 (HDV)Tet and pCV-J4L6S were digested with similar enzymes: *AgeI*+*BsiWI*, *BsiWI*+*BstBI*, *BstBI*+*BglII* and *BglII*+*AflII*. Then, the digested fragments of pCV-J4L6S were transferred into pBac Δ H77 (HDV)Tet in each stage of the digestion. (1), The schematic of cloning the first part of the J4 open reading frame into the pBac Δ H77 (HDV)Tet construct; (2), The schematic of cloning the second part of the J4 open reading frame into the pBac Δ H77(HDV)Tet construct; (3), The schematic of cloning the third part of the J4 open reading frame into the pBac Δ H77 (HDV)Tet construct; (4), The schematic of cloning the fourth part of the J4 open reading frame into the pBac Δ H77 (HDV)Tet construct.

At this stage of the research, the transfer vector of pBacJ4(HDV)Tet Δ 3'UTR construct was modified from pBacMam-2 (Invitrogen, USA) into pFastBac-1 (Gibco, U.K.) for the following reasons: A) with the new system, recombination of the pFastBac vector with the parent bacmid in DH10 β *E. coli* creates an expression bacmid which is more rapid as a method; B) screening the recombinant colonies is easier. DNA isolated from selected colonies is not mixed with parental, non-recombinant virus, which omits the stage for multiple rounds of plaque purification. Disruption of the *lacZ* gene in the parent bacmid by the gene of interest presents white colonies while unsuccessful cloning produces blue colonies on the agar plates. As a result, this decreases the time that it takes for identification and purification of a recombinant virus from 4 to 6 weeks within 7 to 10 days. The transfer vector of pBacJ4(HDV)Tet Δ 3'UTR construct was modified from pBacMam2 into the pFastBac in a two-step procedure. The pFastBac vector was cut with *MluI* restriction enzyme to allow for cloning by the PCR product using the primers encoding for *MluI* and *HindIII* sites into pFastBac. The forward sequence for *MluI* site of pBacJ4(HDV)Tet was 5'-CTG AGG AGT ACG TGG AGG TTA C-3' and the reverse sequence for *MluI* and *HindIII* sites of pBacJ4(HDV)Tet was 5'-GAG AAC GCG TCG GAC CGA AGC TTG GGC TGC AGG TCG AG-3'. In the second stage of cloning the pFastBac vector was digested with *XbaI* and *BstBI* to allow for cloning the second region of J4 genome (*XbaI* and *BstBI*) (Fig. 4). Confirmation of the integrity of the final recombinant plasmid has been shown in the Figures 5 and 6.

A series of vectors containing a culture-adapted replicon [BACrep5.1neo (carrying FK5.1neo replicon)] along with a control polymerase knock-out replicon [BACrepGNDneo (containing FK5.1GNDneo replicon)] used in this research were donated kindly by McCormick *et al.* [8]. Schematic genome organisation of FK5.1, FK5.1GND replicons and J4 Δ 3'UTR are shown in Figure 7.

Cells and viruses. HepG2 cell lines were maintained in the laboratory as routine methods. HepG2 cells were seeded at 3×10^4 cell/cm² 24 hours prior to a 4 hours transduction with 6×10^6 pfu/ml of both BACtTA (tet-controlled transactivator) [BACtTA (Dr. McCormick, University of Leeds, Leeds, U.K.)] and another baculovirus (BacrepJ4 Δ 3'UTRneo, BACtTA was a baculo-virus vector which expressed the tTA

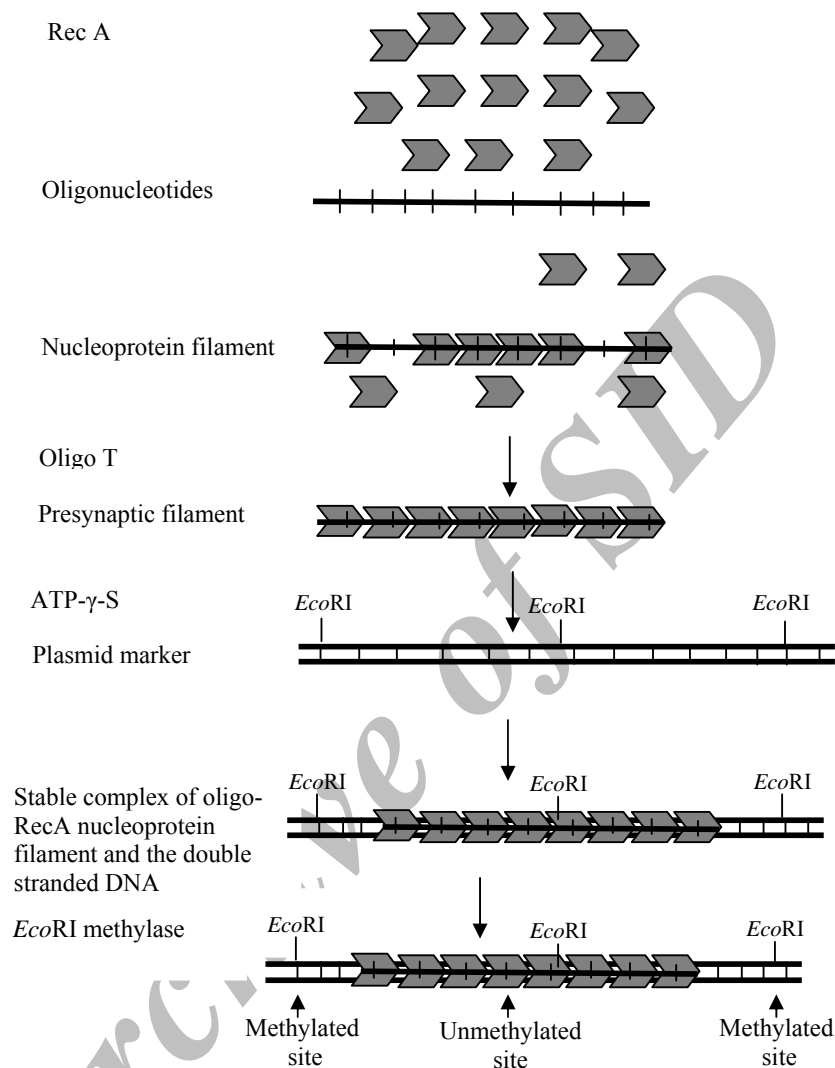

Fig. 3. The experimental design for deletion of 3'UTR of pBacJ4 (HDV)Tet. To delete the 3'UTR which, is required for HCV replication, one of the three *EcoRI* sites in pBacJ4 (HDV)Tet was chosen for protection from methylation by the *EcoRI* methylase and also from *EcoRI* restriction enzyme digestion. The RecA protein was first mixed with a 36-base oligonucleotide sequence homologous to the flanking this site. The RecA protein bound to double-stranded DNA (dsDNA). ATP- γ -S as a non-hydrolyzable ATP analogue was used to protect the assembled RecA filament stability [13]. *EcoRI* methylase methylated all the *EcoRI* sites except the one protected with RecA protein. To improve the specificity of reaction, the oligo T was added to the complex to remove the surplus RecA protein from the media. The RecA-oligonucleotide complex is removed from the site of interest and the methylase is inactivated by heat denaturation (65°C for 15 minutes). The 3'UTR was removed using *AflIII* and *EcoRI* upstream and downstream of the 3'UTR. Finally the sticky ends of DNA were polished by Pfu polymerase and DNA was religated utilizing T4 DNA ligase as described in materials and methods. Religated DNA was transformed into DH5 α and finally the cloned DNA was digested with different restriction enzymes.

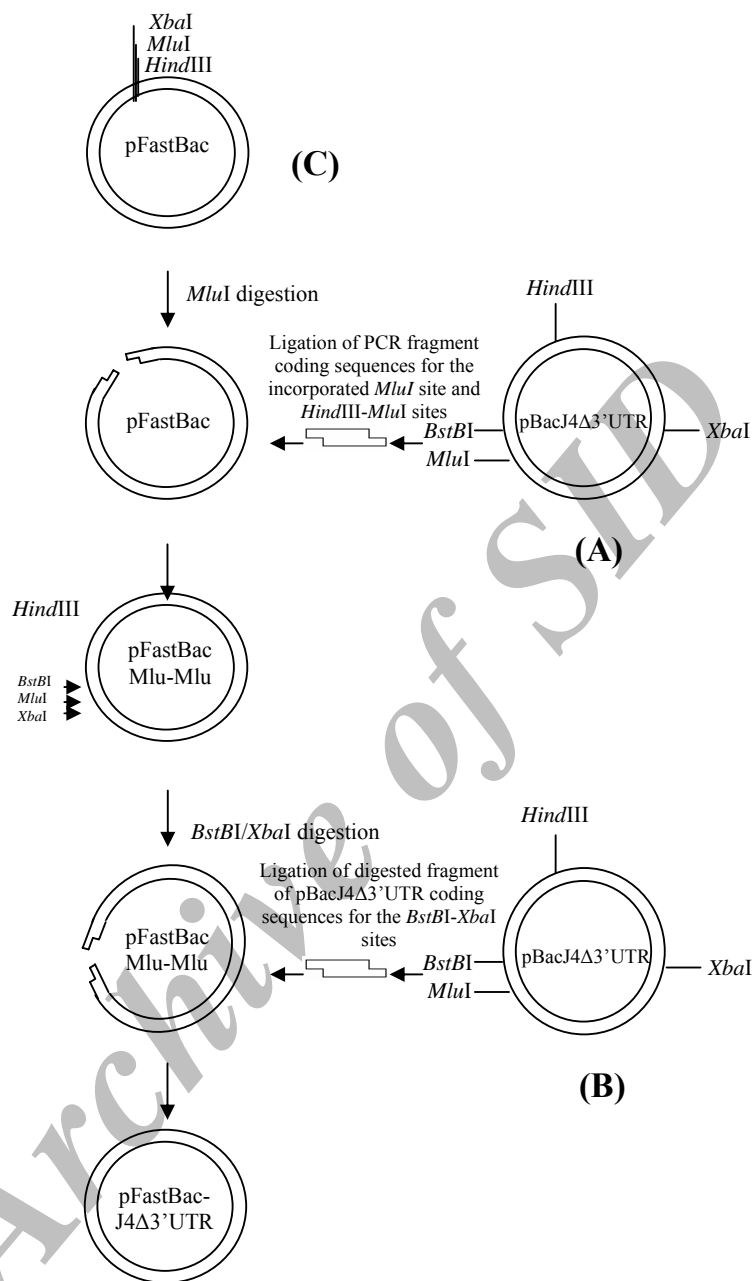

Fig. 4. Diagrams showing the details for cloning the whole genome of J4Δ3'UTR into the new transfer vector system. To clone the complete genome of J4Δ3'UTR into the pFastBac vector, the whole region of J4 genome in the pBacJ4Δ3'UTR construct was divided into 2 parts: The fragment between *Mlu*I and *Hind*III sites (shown as A by an arrow) and the fragment between *Xba*I and *Bst*BI sites (shown as B by an arrow). In the first stage the pFastBac vector was cut with *Mlu*I restriction enzyme to allow for cloning by the PCR product encoding for *Mlu*I and *Hind*III sites into pFastBac. In the second stage of cloning the pFastBac vector was digested with *Xba*I and *Bst*BI to allow for cloning the second region of the J4 genome (*Xba*I and *Bst*BI). **(A)** Diagram showing pBacJ4Δ3'UTR containing the *Mlu*I, *Hind*III and *Bst*BI sites. Also the sites of the forward and reverse primers of *Mlu*I and *Hind*III on the pBacJ4Δ3'UTR is shown by an arrow. The PCR product was amplified such that the reverse primer incorporated an *Mlu*I site into the PCR product to allow the resulting DNA fragment to be cloned into the pFastBac vector cut with *Mlu*I; **(B)** The pBacJ4Δ3'UTR construct was digested with *Xba*I and *Bst*BI to allow cloning the second part of J4 genome into the digested pFastBac vector with *Xba*I and *Bst*BI; **(C)** The modified pFastBac, donated by Dr. Christopher McCormick (University of Leeds, Leeds, U.K.), contained the new sequences for *Xba*I, *Mlu*I and *Hind* III. To confirm the integrity of recombinant clones, the recombinant constructs were digested with restriction enzymes which are explained in the Figure 6.

Table 1. The specific restriction recognition sites for *NarI* and *AgeI*-*EcoRV* and the length of expected fragments. Taken together the right clone (clone No. 5) was chosen to continue the research.

No.	Ends	Coordinates	Length(bp)
1	<i>NarI</i> - <i>NarI</i>	11912-5053	7833
2	<i>NarI</i> - <i>NarI</i>	5054-7968	2915
3	<i>NarI</i> - <i>NarI</i>	8555-10123	1569
4	<i>NarI</i> - <i>NarI</i>	10855-11911	1057
5	<i>NarI</i> - <i>NarI</i>	10124-10854	731
6	<i>NarI</i> - <i>NarI</i>	7969-8554	586
7	<i>AgeI</i> - <i>EcoRV</i>	4446-11434	6989
8	<i>EcoRV</i> - <i>EcoRV</i>	11435-2825	6082
9	<i>EcoRV</i> - <i>AgeI</i>	2826-4445	1620

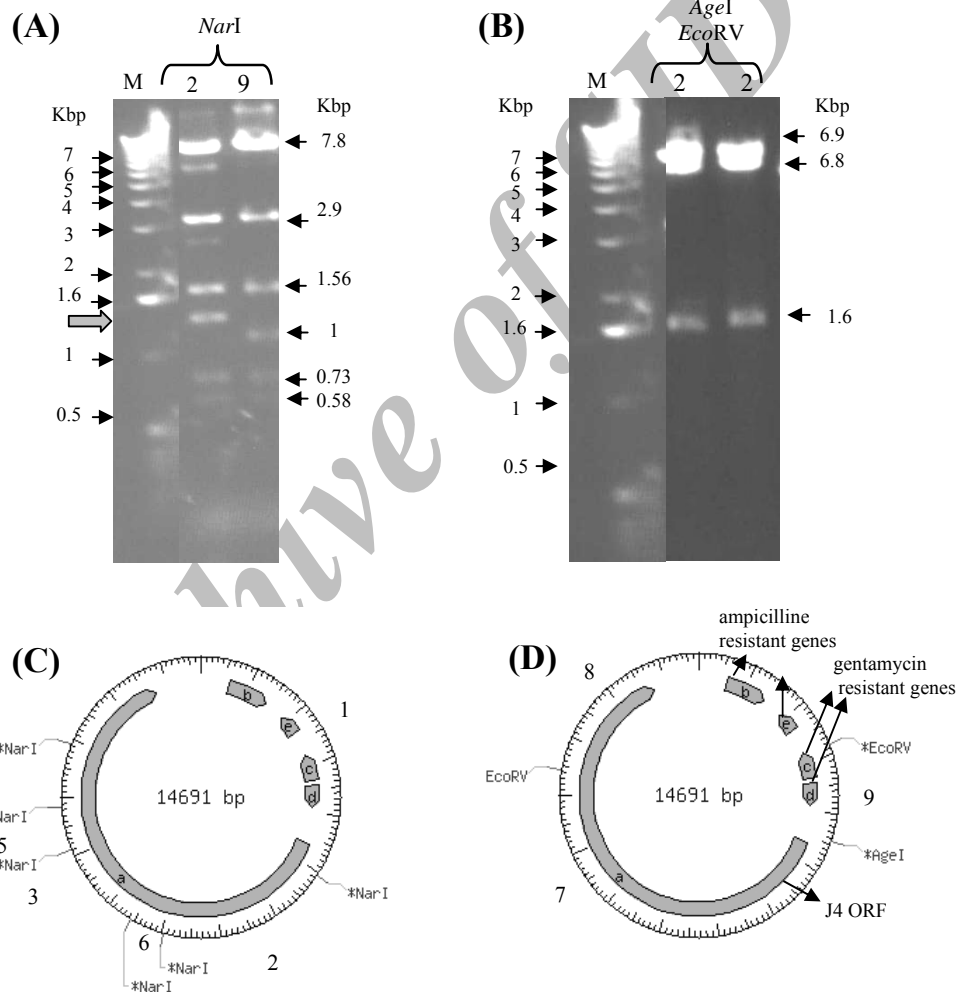

Fig. 5. Confirmation of the integrity of the final recombinant plasmid. (A), confirmation of the integrity of recombinant pFastBac containing J4Δ3'UTR by digestion of 2 different clones with *EcoRV*+*HindIII*. The pattern of clone number 5 was as expected but an unexpected fragment was detected in the pattern of clone number 2, which is shown by a grey arrow. Thus, the integrity of clone number 5 was confirmed; (B), digestion of 2 different clones with *PstI* and *EcoRV*. The pattern of clone number 5 was as expected but there was an unexpected fragment for clone number 2 which is shown by grey arrow. Thus, the integrity of clone number 5 was reconfirmed; (C) and (D), diagrams showing recombinant pFastBac containing the sites of action of the restriction enzymes. The numbers on the diagrams show the region of digestions on Table 1. The letter a on Figure D shows the J4 open reading frame. The letter b shows ampicillin resistance gene. The letters c and d show gentamicin resistance gene. The letter e shows origin of replication gene; M, marker.

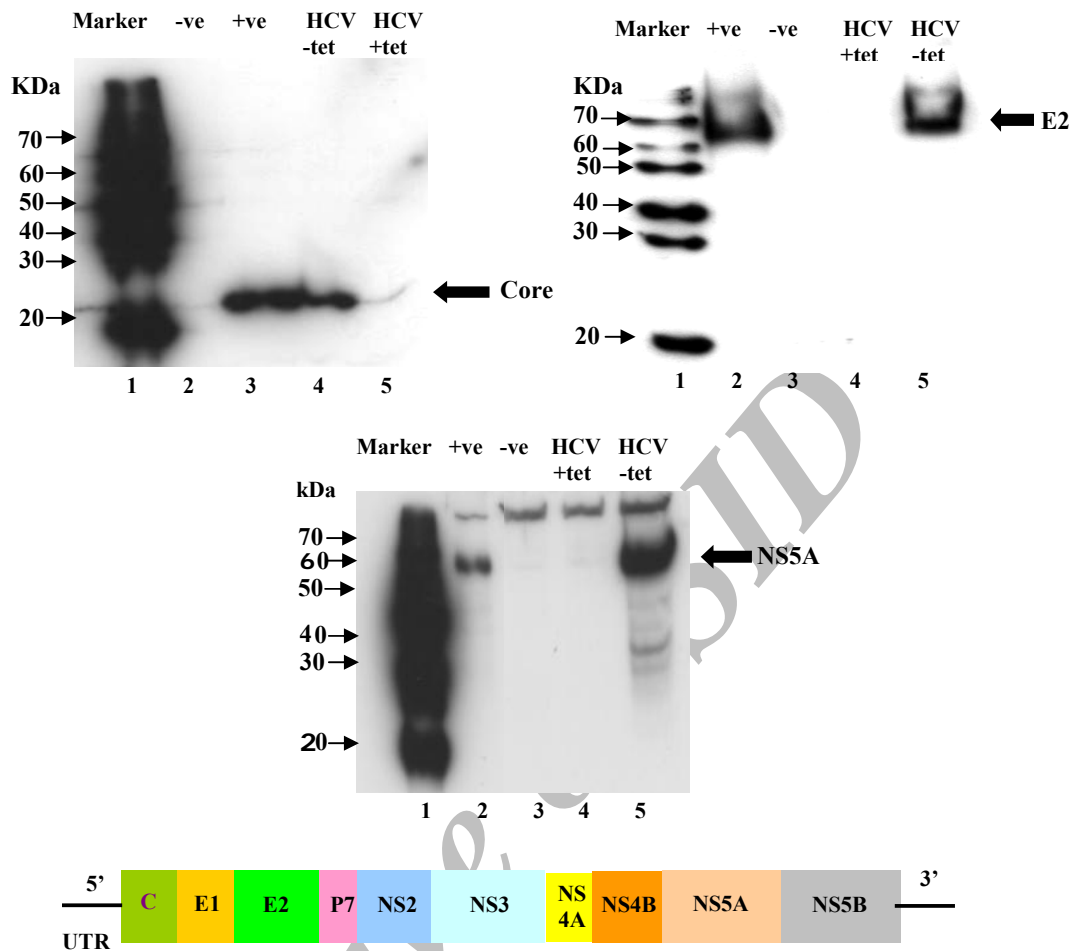

Fig. 6. Tetracycline regulable expression of the HCV polyprotein. To determine whether the HCV polypeptide was produced in the transduced cells, HepG2 cells were co-transduced with both BACtTA and BacJ4 Δ 3'UTR constructs in the presence or absence of 5 μ g/ml tetracycline. BACtTA was a baculovirus vector which expressed the tet-controlled transactivator (tTA) protein which had interaction with an inducible tetracycline element upstream of the 5'UTR. Tetracycline inhibited this interaction. HepG2 cells lysates were analysed by Western blotting method using specific antibodies. Relevant positive controls were included with each test. Human hepatoma cells containing HCV replicon were lysed to be used as a positive control for detecting NS5A. Recombinant baculovirus FBM (C-P7) expressing Core, E1, E2 and P7 proteins was utilized in the experiment as a positive control for expressing Core and E2. (A), confirmation of Core expression in HepG2 cells transduced by Bac J4 (HDV) Δ 3'UTR; (B), confirmation of E2 expression in HepG2 cells transduced by Bac J4 (HDV) Δ 3'UTR; (C), confirmation of NS5A protein expression in HepG2 cells transduced by Bac J4 (HDV) Δ 3'UTR; (D), the schematic of HCV genome structure. The HCV polypeptide contains Core, E1, E2, P7, NS2, NS3, NS4A, NS4B, NS5A and NS5B proteins; Expression of Core, E2 and NS5A proteins confirms the cloning of the whole genome of J4 into the recombinant bacmid and shows the construct is functional.

protein which had interaction with an inducible tetracycline element upstream of the 5'UTR. Tetracycline inhibited this interaction. BacrepFK5.1neo or BacrepGNDneo). For Luciferase reporter assay polyinosinic-polycytidylic acid [poly(I)-poly(C)] was transfected into cells using lipofectin.

Luciferase reporter assay. HepG2 cells were seeded at 3×10^5 cells/well on the 6-well plates and incubated at 37°C for 24 hours. HepG2 cells were

transduced with different appropriate viral constructs (6×10^6 pfu/ml) and incubated at 37°C for 4 hours. The medium was replaced by optimum containing the IFN reporter constructs [The plasmid containing Renilla Luciferase Thymidine Kinase Luciferase (pRLTK-luc)] (Promega, USA) vector containing the HSV-TK promoter and the plasmid containing pIFN β -luc (Dr. Steve Goodbourn, Medical School of St George's Hospital, University of London, UK) or pRLTK-luc (University of Leeds, Leeds, UK,

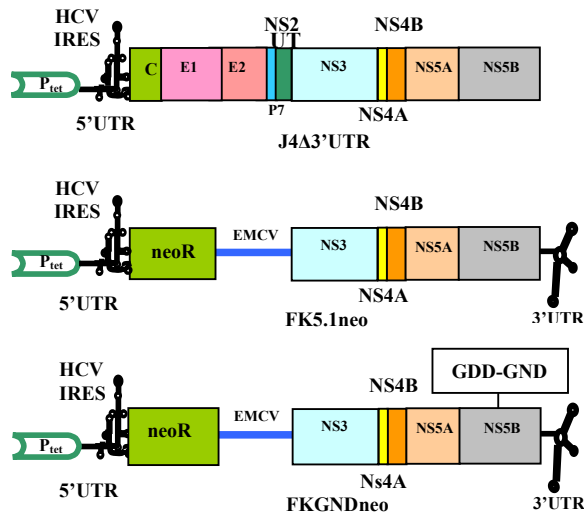

Fig. 7. Schematic genome organisation of J4 Δ 3'UTR, FK5.1 and FK5.1GND replicons. Genome organisation of full-length 3'UTR deletant and HCV replicons which are used in this research are shown in this Figure. Core and envelope proteins (C, E1 and E2) are structural proteins while the rest of the proteins are indicated as non-structural proteins (NS2, NS3, NS4A, NS4B, NS5A and NS5B). The BACrep5.1neo (carrying FK5.1neo replicon) and BACrepGNDneo (containing FK5.1GNDneo replicon) were utilized in this experiment as recombinant baculoviruses containing modified HCV replicons, FK5.1neo and FK5.1GNDneo respectively. Protein expression of all the above-mentioned constructs was under the control of an inducible tetracycline promoter coupled to the 5'UTR. The FK5.1 adapted replicon carries two amino acid substitutions which are located in NS3 and one in NS5A. In addition FK5.1GNDneo contained a point mutation in the active site of NS5B that inactivates the polymerase function. Thus, the latter replicon construct did not replicate in the absence of tetracycline but it expressed the non-structural proteins NS3 through NS5B.

Virology Group) and a plasmid containing IFN Stimulation Response Element gene (pISRE) (Professor Kalle Saksela (University of Tampere Medical School, Finland)]. The concentrations were 100 ng of pRLTK-luc and 500 ng of pIFN β -luc and pISRE per transfection, respectively. The optimum was replaced with 2 ml MEM and the cells were incubated for 14 hours. The cells were harvested with 200 μ l of 1 \times passive lysis buffer. Lysates were analysed by a luminometer (Berthold Technologies Lumat LB 9507) using dual luciferase assay components. Luciferase activity was given in relative light units. The following Luciferase vectors were utilized in this research; pRLTK-luc, pIFN β -luc, pISRE-luc, IFN regulatory factor 3 (pIRF3-luc) (Professor Rick Randall, University of St. Andrews, UK) and pNF κ B (nuclear factor κ B)-luc (Professor

Derek Mann, University of South Hampton, UK). Utilizing the pRLTK vector was intended to provide an internal control, as the baseline response to normalise the results. The pRLTK-luc vector contains the HSV-TK promoter which is located upstream of the complementary DNA (cDNA) expressing Renilla luciferase [9]. p β -luc contains the IFN- β promoter deriving luciferase expression. pISRE-luc plasmid carries the ISRE-binding sequences deriving luciferase expression. pIRF3-luc and pNF κ B-luc plasmids contains the IRF3 and NF- κ B response elements deriving luciferase expression, respectively.

Western-blotting analysis. Cell lysates were loaded on the SDS-PAGE gel and the gel was transferred on a PVDF immobilon transfer membrane (millipore) and blotted under the pressure of an assembled blotter (BIO RAD Trans-Blot SD semi-dryer transfer gel). The blot was blocked in Tris-buffered saline/Tween-20 (TBST) containing 10% marvel (^{W/V}) (dried skimmed milk) followed by using TBST containing 5% (^{W/V}) marvel plus an appropriate primary antibody (Sigma, USA). Bound antibody was detected with either sheep polyclonal anti NS5A, mouse monoclonal anti Core and mouse monoclonal anti E2 (ALP98) (a gift which was donated kindly by Dr. Arvind H. Patel, Institute of Virology, Glasgow, USA) as secondary antibodies (Sigma, USA) and also ECL reagent (Amersham Pharmacia, USA).

RESULTS

In this research, an efficient delivery system for the introduction of an infectious HCV (1 b) viral genome into cells was generated (BacJ4 Δ 3'UTR). This delivery system was a new scheme, because it contained the complete genome of HCV1b providing opportunity to study the effect of polyprotein on IFN signalling pathway. This facilitated the investigation of the characteristics of HCV1b proteins. The results obtained confirmed that an efficient baculovirus delivery system can be developed to introduce the whole genome of HCV into hepatoma cells, which could express the whole HCV1b polyproteins *in vitro*.

An inducible tetracycline-responsive promoter coupled to the HCV 5'UTR controlled the expression of full length HCV1b polypeptide which allowed HCV protein expression in the absence of

tetracycline. This delivery system was potentially able to generate correctly the full-length HCV1b polypeptide. Authentic proteolytic processing of the polyprotein was shown by Western blotting analysis (Fig. 6). This also shows tight tetracycline responsive control of polyprotein expression. The efficiency of this construct was confirmed by expressing different HCV proteins in HepG2 cell (Fig. 6).

To address the question of IFN- β resistance in more details, the developed baculovirus delivery system introduced the whole genome of HCV into hepatoma cells. This construct lacked the 3'UTR that was required for HCV replication. Thus, the construct made it possible to look at the effects of HCV proteins on the IFN- β signalling pathway without inducing IFN- β expression by virtue of the presence of replicating viral RNA.

To determine whether the complete HCV polyprotein could modulate IFN signalling pathways, HepG2 cells were transduced with different recombinant baculoviruses either Bac J4 Δ 3'UTR, which delivered the full-length 3'UTR of the culture adapted (FK5.1) or BacrepGNDneo containing a polymerase-defective (FK5.1GND) replicon. FK5.1 adapted replicon carries two amino acid substitutions in NS3, and one in NS5A, that have synergistic function [10] to enhance RNA replication. Following baculovirus-mediated delivery, HepG2 cells were co-transfected with the luciferase constructs and luciferase activity measured by standard procedures. The vectors were utilized in this research were pRLTK-luc, p β -luc, pISRE-luc, pIRF3-luc and pNF κ B-luc. Utilizing the pRLTK vector was intended to provide an internal control, as the baseline response to normalise the results. The pRLTK-luc vector contains the HSV-TK promoter which is located upstream of the cDNA expressing Renilla luciferase [9]. p β -luc contains the IFN- β promoter deriving luciferase expression. pISRE-luc plasmid carries the ISRE-binding sequences deriving luciferase expression. pIRF3-luc and necrosing factor κ B luciferase (pNF κ B-luc) plasmids contains the IRF3 and NF- κ B response elements deriving luciferase expression, respectively.

The effect of BacJ4 Δ 3'UTR containing HCV1b Δ 3'UTR on the induction of IFN- β promoter and on the transcription response to IFN- β was analysed utilizing a dual luciferase assay system. In HepG2 cells, transcription from the IFN- β promoter was not induced following baculovirus-mediated delivery of either the full-length complete HCV

polyprotein (data not shown) or a replication defective sub-genomic replicon (FK5.1GND). However, in line with previous data [9], baculovirus-mediated delivery of a replication competent sub-genomic replicon (FK5.1) into HepG2 cells resulted in major activation of the IFN- β promoter (data not shown). RNA replication was able to induce the IFN- β promoter, presumably by virtue of the presence of replicative dsRNA.

To investigate the interaction of HCV proteins and the transcriptional factors IRF3 and NF- κ B, HepG2 cells were transfected with pIRF3-luc and pNF κ B-luc plasmids and also poly I/C. The activation of IRF3 and NF- κ B by poly I/C could be influenced by either a replication competent sub-genomic replicon (FK5.1) or a defective sub-genomic replicon (FK5.1GND) in HepG2 cells (Figs. 8 and 9).

In this research, evidence was presented that both the wild type and GND-mutant replicon, encoding the HCV non-structural proteins, blocked the dsRNA-induced activation of IRF3 and NF- κ B (Figs. 8 and 9). This is consistent with the data which shows that NS3/4A is capable of inhibiting activation of IRF3 and NF- κ B induced by HCV [11] which documents the major interfering role of NS3/4A in IFN- β signalling pathway [11].

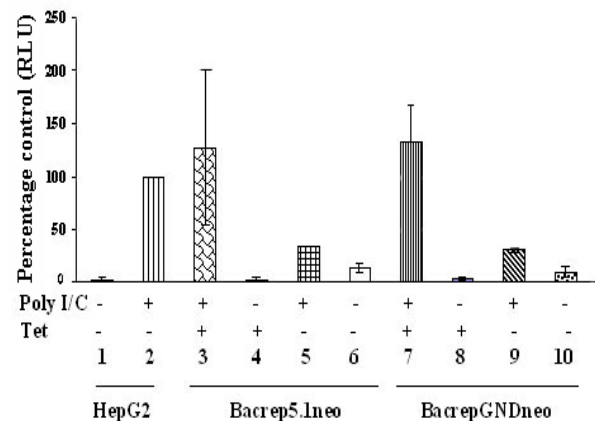

Fig. 8. Inhibition of transcriptional activation of IRF3 response element by HCV replicons. HepG2 cells were transduced with BactA and with either baculoviruses Bacrep5.1neo or BacrepGNDneo in the presence and absence of tetracycline. HepG2 cells were co-transfected with pIRF3-luc and pRLTK-luc. The indicated cells were transfected with poly I/C at 5 μ g/ml. The Figure shows the level of luciferase reporter (pIRF3) activity which was normalised by using an internal control (pRLTK-luc plasmid) in three independent experiments. Luciferase activity was given in relative light units. Percentage of control of relative light units was obtained for each sample.

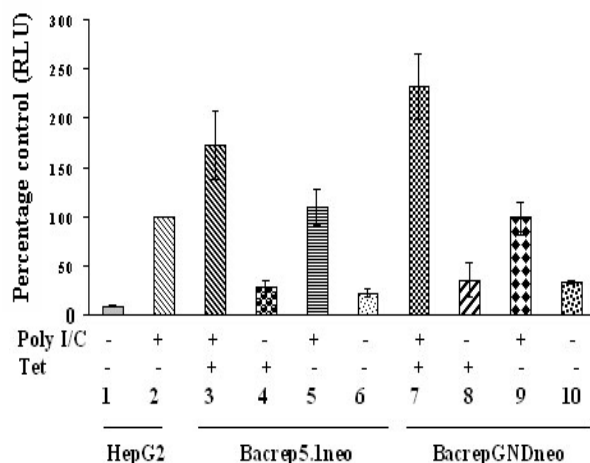

Fig. 9. Inhibition of transcriptional activation of NF- κ B response element by HCV replicons. HepG2 cells were transfected with BactTA and with either baculoviruses Bacrep5.1neo or BacrepGNDneo in the presence and absence of tetracycline. HepG2 cells were co-transfected with pNF κ B-luc and pRLTK-luc. The indicated cells were transfected with poly I/C at 5 μ g/ml. The Figure shows the level of luciferase reporter activity which was normalised by using an internal control (pRLTK-luc) in three independent experiments. Percentage of control of relative light units was obtained for each sample.

Reducing the level of TRIF (TIR-domain-containing adapter-inducing IFN- β which links toll-like receptor 3 (TLR3) to kinases necessary for activation of IRF3 and NF- κ B) as a result of mediated cleavage of NS3/4A, inhibits the transcriptional response of IRF3 [11, 12]. Whether this effect can be seen *in vivo* is the subject which remains to be elucidated. In contrast, it is notable that the full-length 3'UTR deletant expressed by a non-culture adapted virus had no major effect on the activation of either the IRF3 or NF κ B response elements (data not shown).

Another stage at which HCV may effect IFN- β signalling is the level of IFN- β stimulation on transcription response to IFN- β . Thus, the effect of the complete HCV polyproteins and the HCV subgenomic replicons on the transcriptional response to IFN- β were studied utilizing pISRE-luc as a luciferase reporter. ISRE (a common *cis*-acting DNA sequence) is the target for transcriptional activation by the IFN-stimulated gene factor complex. In the absence of tetracycline, activation of transcription from the ISRE by IFN- β in HepG2 cells was not modulated by expression of either the complete HCV polyprotein or the sub-genomic replicon in the replication competent or defective constructs (data not shown). As expected, the positive control, SV5-V protein (a well-

characterized inhibitor of ISRE activation), noticeably inhibited ISRE activity and justified the results.

DISCUSSION

In the first part of this research to address the question of modulation of IFN- β signalling by the complete HCV polyproteins in more details, an efficient delivery system utilizing baculovirus was generated. The ability of full length HCV to undergo RNA replication thereby inducing an IFN- β response was an obscure to overcome. Thus to circumvent this, a construct lacking the 3'UTR was generated. Furthermore, the expression of HCV polyproteins was regulated under the control of a tetracycline responsive promoter coupled to the HCV 5'UTR. The results obtained show the successful cloning of the HCV genome into a baculovirus vector which was utilized in the later stages of this research.

The aim of the later part of this research was to study the modulation of IFN- β signalling by the complete HCV polyprotein and HCV subgenomic replicon. To achieve this aim, first the effect of HCV on the activation of IFN- β induced by dsRNA was investigated. The results obtained show that the complete HCV polyprotein did not have the capability to induce the IFN- β promoter which was as expected. Furthermore, the complete HCV polyproteins could not modulate the transcription induction of the IFN- β pathway, induced by poly I/C. However, as expected, a competent replicative (FK5.1) replicon underwent RNA replication in HepG2 cells and induced IFN- β induction in the absence of tetracycline. This is consistent with previous data reported by McCormick *et al.* [9]. Induction of IFN- β presumably occurred by virtue of the presence of replicative dsRNA, as a polymerase defective (FK5.1GND) replicon failed to induce IFN- β production.

The activation of both IRF3 and NF- κ B, two key transcription factors in the stimulation of IFN signalling was investigated. Intriguingly, the results obtained show both wild type and GND-mutant replicon, encoding the HCV non-structural proteins, blocked the dsRNA-induced activation of IRF3 and NF- κ B (Figs. 8 and 9).

These results are in agreement with previous reports confirming the capability of NS3/4A in inhibition of IRF3 and NF- κ B activation induced by HCV [11]. The mechanism occurs by cleavage of TIR domain containing adaptor inducing IFN-beta

(TRIF), as an adaptor protein which links TLR-3 to kinases, which inhibits the transcriptional response of IRF3 [11, 12].

The exact mechanisms by which HCV can evade the host response have become controversial. Thus, inhibition of the transcriptional response to IRF3 and NF κ B seems to be one of the multiple mechanisms which HCV employs to escape the host immune defence and may also be considered as a possible causative factor in HCV persistence. In contrast the full length 3'UTR deletant had no significant effect on either transcription factor. These results may be attributed to the function of HCV subgenomic replicons compared with full length 3'UTR deletant. The occurrence of adaptive mutations harboured by HCV replicons may change naïve functions of HCV replicons to survive the innate response. Thus, different conclusions obtained with regard to interactions of either full length 3'UTR deletant or replicon and the transcriptional response to IRF3 and NF κ B, may be attributed to the different characteristics of the replicon and HCV 3'UTR deletant.

The discrepancy in the latter results obtained, is the inhibition of transcriptional activation of IRF3 and NF- κ B response element by replicon FK5.1 while this construct induced an IFN- β response effectively in a separate experiment. To explain this, it should be noted that there is a possibility that FK5.1 inhibits IRF3 and NF- κ B separately but it may also increase the level of ATF-2/c-Jun, another transcription factor involving the secretion of IFN- β , which outlines an increased level of the IFN- β expression. On the other hand, there might be other unknown mechanisms by which HCV replicons activate the IFN- β expression.

In the next stage of our experiments the effect of HCV full length 3'UTR deletant and also HCV replicons on the IFN- β signalling was analysed. Under experimental conditions, neither the full length HCV 3'UTR deletant nor the HCV replicons had an effect in the modulation of the transcription response to ISRE induced by IFN- β . It must be considered that the observed lack of an effect of HCV full length 3'UTR deletant and also HCV replicons on transcriptional response to IFN- β may be similar or different so that it possible to observe *in vivo*, because human hepatocarcinoma cells (hepG2) utilized in this research are different from normal liver cells in some requirement for their biological function.

The results obtained in this study suggest a complex interplay between HCV and IFN- β

signalling. Thus, a number of significant questions await further investigation. One question has to do with defining the detailed mechanisms by which HCV may inhibit the transcriptional response to IRF3 and NF κ B. It will be of interest to determine if other HCV proteins have a similar role to NS3/NS4A. In addition, more work would be required to clarify the effect of HCV protein on each individual protein involved in the activation of IRF3 and NF- κ B triggered by TLR3. This would reveal the IFN- β signalling pathway in more detail. Future research will undoubtedly be required to answer the questions if HCV proteins modulate the transcription response to ISRE *in vivo* and if full length HCV employs the same mechanisms which replicons apply to modulate IFN signalling and finally if the results obtained utilizing replicons attributable to *in vivo*.

From the data obtained, a potential role of HCV proteins in interference with transcriptional response to IRF3 and NF- κ B could be inferred. The results also suggest a complex interplay between HCV and the IFN- β system that is dependent both on the context of the complete HCV polyprotein expression (compared with sub-genomic replicon) and the primary amino acid sequence (culture adapted compared with infectious clone). These observations outlined the multiple possibilities that HCV may employ to persist in host cells. Thus, inhibition of the transcriptional response to IRF3 and NF κ B seems to be one of the mechanisms which HCV employs to escape the immune system and may also be considered as a possible causative factor in HCV persistence.

ACKNOWLEDGEMENTS

We thank Professor David Rowlands (University of Leeds, Leeds, U.K.) and Professor Mark Harris (University of Leeds, Leeds, U.K.) for their constant supports and Dr. Christopher McCormick (University of Leeds, Leeds, U.K.) for providing pBac Δ H77(HDV)Tet, BACrep5.1neo and BACrep-GNDneo. Also, we wish to thank Dr. Steve Goodbourn (Medical School of St. George's Hospital, University of London, U.K.), Professor Kalle Saksela (University of Tampere Medical School, Finland), Professor, Rick Randall (University of St. Andrews), Professor Derek Mann (University of South Hampton) for providing pIFN β -luc, pISRE-luc, pIRF3-luc, pNF κ B-luc, respectively.

REFERENCES

1. McHutchison, J.G. (2004) Understanding Hepatitis C. *Am. J. Manag. Care* 10: S21-S29.
2. Hoofnagle, J.H. (2002) Course and outcomes of hepatitis C. *Hepatology* 36: S21-S29.
3. Major, M.E., Rehmann, B. and Feinstone, S.M. (2001) Fields Virology. (Knipe, D.M., Howley, P.M., Griffine, D.E., Lamb, R.A., Martin, M.A., Roizman, B. and Strause, S.E. eds.) Lippincott, Williams and Wilkins, 4th ed., Philadelphia, PA. pp. 1127-1161.
4. Wakita, T., Pietschmann, T., Kato, T., Date, T., Miyamoto, M., Zhao, Z., Murthy, K., Habermann, A., Kräusslich, H.G., Mizokami, M., Bartenschlager, R. and Liang, T.J. (2005) Production of infectious hepatitis C virus in tissue culture from a cloned viral genome. *Natl. Med.* 11: 791-796
5. Drusano, G.L. and Preston, S.L. (2004) A 48-week duration of therapy with pegylated interferon alpha 2b plus ribavirin may be too short to maximize long-term response among patients infected with genotype-1 hepatitis C virus. *J. Infect. Dis.* 189 (6): 964-970.
6. Bartenschlager, R., Kaul, A. and Sparacio, S. (2003) Replication the Hepatitis C Virus in the cell culture. *Antiviral. Res.* 60: 91-102.
7. Missale, G., Cariani, E. and Ferrari, C. (2004) Role of viral and host factors in HCV persistence: which lesson for therapeutic and preventive strategies? *Dig. Liver Dis.* 35: 703-711.
8. McCormick, C.J., Challinor, L., Macdonald, A., Rowlands, D.J. and Harris, M. (2004) Introduction of replication-competent Hepatitis C Virus transcripts using a tetracycline-regulable baculovirus delivery system. *J. Gen. Virol.* 85: 429-439.
9. Fedoruk, M.N., Giménez-Bonafe, P., Guns, E.S., Mayer, L.D. and Nelson, C.C. (2004) P-glycoprotein increases the efflux of the androgen dihydrotestosterone and reduces androgen responsive gene activity in prostate tumour cells. *The Prostate* 59: 77-90.
10. Krieger, N., Lohmann, V. and Bartenschlager, R. (2001) Enhancement of Hepatitis C Virus RNA replication by cell culture-adaptive mutations. *J. Virol* 75: 4614-4624.
11. Li, K., Foy, E., Ferreon, J.C., Nakamura, M., Ferreon, A.C.M., Ikeda, M., Ray, S.C., Gale, M.Jr. and Lemon, S.M. (2005) Immune evasion by Hepatitis C Virus NS3/4A protease-mediated cleavage of the Toll-like receptor 3 adaptor protein TRIF. *Proc. Natl. Acad. Sci. USA* 102: 2992-2997.
12. Breiman, A., Grandvaux, N., Lin, R., Ottone, C., Akira, S., Yoneyama, M., Fujita, T., Hiscott, J. and Meurs, E.F. (2005) Inhibition of RIG-I-Dependent signaling to the interferon pathway during Hepatitis C Virus expression and restoration of signaling by IKKε. *J. Virol.* 79: 3969-3978.
13. Kuzminov A. (1999). Recombinational repair of DNA damage in *Escherichia coli* and bacteriophage lambda. *Microbiol. Mol. Biol. Rev.* 63: 751-813.