

# A RELIABLE AND ECONOMICALLY FEASIBLE AUTOMATIC METER READING SYSTEM USING POWER LINE DISTRIBUTION NETWORK

*M. Moghavvemi, S.Y. Tan and S. K. Wong*

*Department of Electrical Engineering, University of Malaya, Malaysia, [mahmoud@um.edu.my](mailto:mahmoud@um.edu.my)*

(Received: – Accepted in Revised Form: )

**Abstract** Automatic Meter Reading (AMR) is the remote collection of consumption data from customer's utility meters over telecommunications, radio, power line and other links. AMR provides water, electric and gas utility-service companies the opportunities to streamline metering, billing and collection activities, increase operational efficiency and improve customer service. Utility company uses technologies that were developed several decades ago with the majority of the meters being read visually. With manual readings, considerable time is used to physically check out each unit. AMR becomes a viable option to overcome this problem of time wastage to obtain the meter readings. There are many different forms of communication links that can be utilized as the communication medium in an AMR system. One such link is the power line carrier or PLC. The advantages of using the PLC as the communication medium are readily apparent since the power line network is the property of the utility company and its infrastructure is already there. However, power lines are never meant for communication and creates much noise and therefore, various modifications has to be made to make the PLC suitable to be the AMR communication channel. The AMR system consists of three major components: the meter interface module, communications system, and data concentrator. This paper details a feasibility study on the creation of a robust bi-directional/two-way communication system between an electricity meter and a distant control unit (data concentrator) over the low voltage (LV) distribution grid. Basic functions of the AMR system include the provision for remote connection and disconnection of meter and fraud detection features at both the meter interface and the data concentrator. As a support system to the entire AMR, batteries are utilized. They are especially important in the cases of power failures. Lithium-ion batteries are the type of batteries that are used as these batteries tend to last longer than most other batteries. The main advantage of this system is that it is a low cost system that produces very encouraging results and it can be implemented upon existing electro-mechanical meters without the need of purchasing new meters. With many existing meters being the electro-mechanical meters, the need for a high-cost, large-scale implementation of new electronic device meters to enable implementation of the AMR system is unnecessary. The cost of implementation is low and the benefits, especially economically, that it brings to the utility company are immense.

**Key words**

چکیده

## **1. INTRODUCTION**

Utility company typically uses technologies that were developed several decades ago to collect meter reading for billing purposes. The majority of the meters are read visually and manually recorded in a meter book. Manual readings cause entry errors and considerable time is used to physically check out each unit. An English study has shown that a meter reader achieves an average information rate of only about 1 bit/s.[1] Furthermore, the need to read hard-to-access meters becomes very strong.

Automatic Meter Reading (AMR) in very simple terms emphasizes the meter reading aspects of a particular utility function with the absence of any human intervention.[2] AMR is the remote collection of consumption data from customers' utility meters. Meter reading is all about communication, that is, the accurate conveying of information from thousands of separate locations (the meters) to one location (utility's office). AMR systems are best classified by which technology links that are used to communicate. Telephone, radio, and power line carrier are the three most popular. Apart from that, AMR provides different utility companies, such as, the electricity, gas and water utilities the opportunity to perform meter-reading functions over these communication links. With the opportunity to streamline metering and billing, collection activities as well as to enhance service to customers through AMR, thus, AMR has become the utilities' gateway to present and future customers and can provide a strategic platform for building sustainable competitive advantage for that particular utility company.

Existing AMR scheme in operation is using the telephone line to communicate with the meter from the central station and is installed mainly at mega or huge consumers. For special projects, AMR scheme can be realized by partly PLC technology and partly by telephone or fiber-optic communication. AMR systems are still pretty new in this country and are still in the developmental and testing stages especially in connection with the PLC communication medium system. A large-scale working AMR system through PLC communication link is yet to be successfully implemented here but a prototype system is currently being developed at National Utility Research Department.

## **2. HISTORY OF AMR**

AMR was first tested about 40 years ago when AT&T conducted trials in cooperation with a group of utilities and Westinghouse. After those successful experiments, AT&T offered to provide phone-based AMR services at \$2 per meter. The price was four times more than the monthly cost of a person to read the meter. Thus, the program was considered economically unfeasible. However, in 1972, the General Electric Corporate Research Center, in conjunction with GE Meter Department in Somersworth, New Hampshire, began an R&D effort for a remote meter reading system for centralized TOU (Time-Of-Use) metering called AMRAC. Meanwhile, at Rockwell International, a Utility Communication Division had been founded in 1977 to develop distribution carrier communication systems. In the fall of 1984, General Electric acquired from Rockwell International an exclusive license to commercialize their distribution line carrier product designs, related research and technology. The modern era of AMR began in 1985, when several major full-scale projects were implemented. Hackensack Water Co. and Equitable Gas Co. were the first to commit to full-scale implementation of AMR on water and gas meters respectively. In 1986, Minnegasco initiated a 450,000-point radio-based AMR system. In 1987, Philadelphia Electric Co, faced with a large number of inaccessible meters, installed thousands of distribution line carrier AMR units to solve this problem.[3] Advances in solid-state electronics, microprocessor components and low-cost surface-mount technology assembly techniques have naturally been the catalyst to produce reliable cost-effective products capable of providing the economic and human benefits that justify the use of AMR systems on a large-scale basis.

## **3. FUNCTIONS OF AMR**

Figure 1 shows some of the metering functions provided by Automatic Meter Reading (AMR). All of these functions can be consolidated into one system through advanced metering techniques.

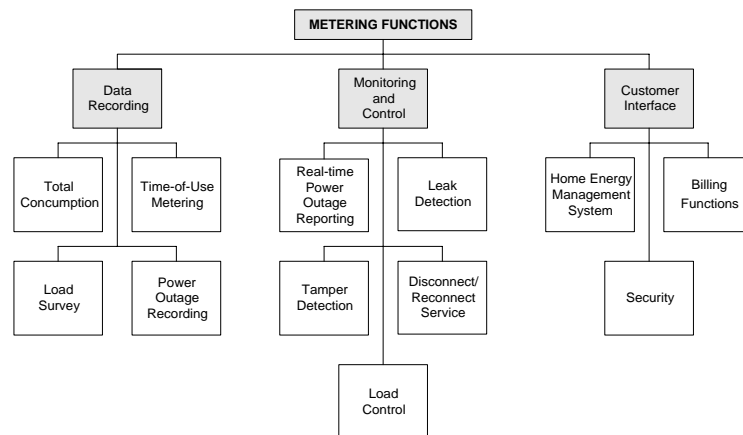

*Figure 1 : Metering Functions*

Detailed data can improve service, management and strategy. Water, electric and gas utilities can use the data collected through AMR for numerous internal and external programs. Apart from the conventional metering function of recording total consumption, advanced meters also offer enhanced functions such as Time-of-Use (TOU) metering. For this purpose, different rates can be charged for on-peak and off-peak time periods. For an electricity meter, it is possible to record other electricity characteristics such as voltage, current and power factor. Energy consumption studies and more complex analysis of system loading require more detailed data. A load survey provides periodic consumption or demand data. By recording the time and duration of each power outage, the quality of electric power service can be evaluated.

A two-way communication link between the central station and customers' premises provides the opportunity for integrating some other utility functions into the metering functions. Utilities that use AMR to collect data daily or hourly can offer even more targeted value-added services such as leak detection and outage alarms. With 15-minute reads, utility can offer near-real-time outage detection. An AMR system is also able to combat meter tampering and electricity theft. Real-time reporting can help the utility identify the location and scope of problems before sending crews to the field. Also, the utility is able to connect or disconnect the delivery of power without having an on-site visit.

Home Energy Management System (EMS) involves measurement and display of utilities consumption. This information can be directly obtained from advanced meters. Other tools that AMR data can provide are aggregate billing and consumption comparisons. Multiple-point customers such as government offices, schools and retail chains want the ability to pay one electricity bill instead of 10, 20 or 100. They also want to compare energy consumption at various facilities. Overlapping billing periods make it much easier for customers to compare consumption and generate savings. Some companies already have individualized programs in place. A few companies allow customers to choose the day they are billed and when payments are due. Advanced metering and billing systems can make this level of service easy to provide.

#### 4. COMMUNICATION TECHNIQUES

Meter reading is all about communication — accurately conveying information from thousands of separate locations (the meters) to one location (utilities office). Automatic meter reading technology has become more complex with many varieties of communication methods and processing systems. There are several technologies which have been proven to be successful in multiple applications, such as,

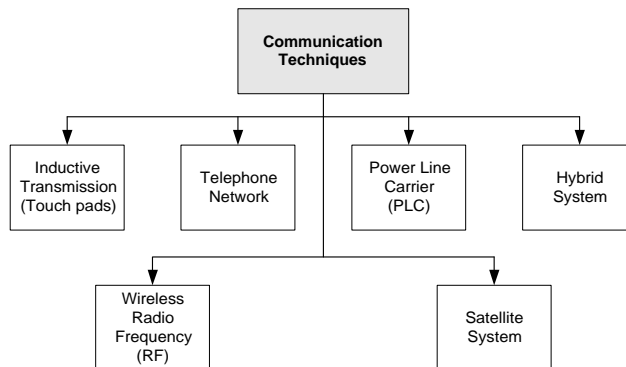

*Figure 2 : Communication Techniques*

There are several types of RF system available for reading meters remotely. The most common types are vehicle-based and handheld. The handheld system is termed ‘walk-by’. In this case, the meter reader walks a route of streets with a receiver unit, which collects data from all the meters located in a particular area. In another scenario, vehicle-based mobile radio system is also known as ‘drive-by’. The vehicle-based systems usually use a van outfitted with a personal computer, transmitter and receiving equipment as well as appropriate software. This, of course, greatly increases reading speed and is highly efficient.

Inductive reading has become very popular. While it still requires a meter reader to visit the property, it does not require access to the meter and can store a 100% accurate reading very quickly. A ‘pad’ is wired to the meter and mounted on an exterior wall of the property. The pad is read by touching a reading ‘probe’ to the pad and pressing a button. A coil within the probe is energized which in turn energizes the coil within the pad. Therefore, data is transferred inductively. The probe then transmits the data to a handheld computer where it can be stored. The stored data is downloaded to the billing system at the end of each day. This technique is very important in solving inaccessible meter problems. An easy solution is to have a data transfer link (‘touch pad’) that is hard-wired to the meter and located at an accessible location.

The existing telephone system already provides two-way communication to nearly all residential, commercial, and industrial facilities. Therefore, it seems to be an attractive communication link for an AMR system. However, it is critical that AMR system related communication does not interfere with normal voice operation, does not interrupt normal voice traffic, and does not cause the telephone to ring. Although telephone-based communication systems are relatively inexpensive, there are some serious issues that must be addressed. Many customers fear that the utility will be able to listen in on their private telephone conversations. They also fear that their private telephone line may not be available when they need it, such as during an emergency. In addition, the telephone number management has proven to be a real administrative problem. Customers who change their telephone numbers or move away from a site and discontinue their telephone service can also disrupt the AMR system.

Satellite communication is by far the most advanced metering technique. Satellites offer a number of features not readily available with other means of communications. Because very large areas of the earth are visible from a satellite, the satellite can form the star point of a communication net linking together many

users simultaneously, users who may be widely separated geographically. An AMR network can be easily established between a ground-based transmitter installed at the meter and a satellite in space. The satellite will capture any metering data from a number of ground-stations (meters) and send the data to the central office on earth. The most common type of satellite used for this application is the low-earth orbit (LEO) satellite, which may have circular orbits from 700 km up to 2000 km in altitude. Low earth orbit satellite is preferred in AMR systems due to lower costs and its ability to provide services to handheld transceivers. By completely integrating a radio under the cover of an electricity meter, the meters can easily be checked remotely.

An AMR system can also use more than a single communication technology. Hybrids of radio and telephone, or telephone and power line carrier, or radio and power line carrier have advantages in some applications. Hybrid systems use an intermediate communication node between the gateway and the utility to combine and distribute information to a limited number of devices within a particular area. These concentrating units allow data to be processed locally and the results to be forwarded to the head-end. Communication between the neighborhood node and the head-end often uses a higher bandwidth link, such as, fiber-optic networks or conditioned high-speed dedicated data links. Multiple communication technologies may be selected to best match the needs of different meter reading conditions found throughout the service territory.

## 5. PLC AS THE COMMUNICATION LINK

Power line carrier or PLC would seem to be the natural choice for communication as it would utilize infrastructure already in control by the electric utilities and can potentially reach any point in the power network.[4] Electrical power lines are usually classified into the low ( $< 1\text{kV}$ ), medium (1 - 100 kV), and high ( $> 100\text{ kV}$ ) voltage networks with respectively increasing communication difficulties.[5] If an information signal is transmitted over power lines for distances of miles, the power company's distribution transformers are likely to present major obstacles.[6] In order to serve the above purpose, the communication system must provide high link availability despite the unpredictable transmission characteristics of the signal path. A core strategy is to use the Low Voltage (LV) distribution networks for communication, which is basically everything attached to the secondary side of the distribution transformer including the low-voltage network within the consumers' premises and all loads connected to it.[7]

## 6. CHANNEL MODELS

It is very difficult to determine an accurate model of power line communications channel since most of the channel parameters vary with time, load, frequency, etc. Yet, several distinct topologies are accepted as being reasonable representation of the channel. Dostert proposed the circuit-theoretical model shown in Figure 3.[8] The model shown in Figure 4 was proposed by Onunga et al. Here, the filter response  $H(f,t)$  varies to reflect the change in electrical loads.  $A(t)$  represents fading and is often periodic, while  $B(t)$  is the fading level of the noise relative to the signal. Note that all elements are time-dependent ( $t$ ). Other elements needed to be considered are BW limitation, noise and disturbances, channel impedances, signal attenuation, standing wave consideration, SNR, time variant behavior of the grid and EMC.[9]

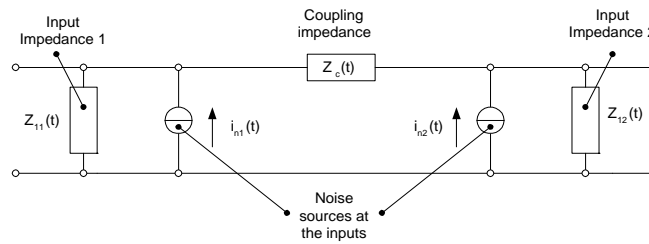

Figure 3 : Dostert's PLC Channel Model

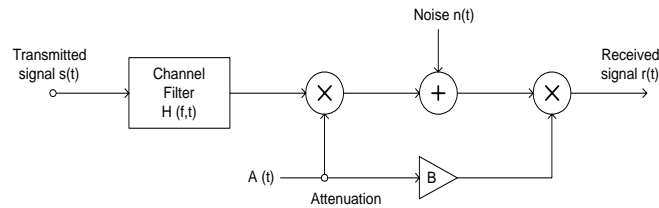

Figure 4 : Onunga's PLC Channel Model

## 7. BANDWIDTH LIMITATIONS

The fundamental parameter that controls the rate and quality of information transmission is the channel bandwidth, BW. The bandwidth of a channel is the range of frequencies that it can transmit with reasonable fidelity. The rate of information transmission (baud rate) is directly proportional to BW, therefore, a large bandwidth is needed in order to communicate with high bit rates. Regulatory authorities limit the available bandwidth. Different countries would have different standards and regulations.

In order to provide a sound foundation for low voltage communications, the EEC's electrical standardization body, CENELEC, has developed a standard, EN-50065 for Europe.[10] This standard embraces several key parameters such as frequency range and signal power, which will provide the potential for efficient communication between the utilities and their customers. The transmitted power depends on the specific channel and coupling method, but is not to exceed 500 mW. The frequency bands are divided into two main categories as follows:

Utility signaling band: 3 kHz – 95 kHz

Customers band: 95 kHz – 148.5 kHz

The band from 3–95 kHz or A-Band, is allocated for electrical utility use including automatic meter reading. The range from 95–148.5 kHz comprising the B, C, and D bands is reserved for end-users (utility customers) applications.

The power line regulations in USA are different from those applied in Europe in terms of frequency band allocation and bandwidth. The Federal Communications Commissions (FCC) regulations specifies that the power line communications should have a bandwidth of 350 kHz, allocated in the band of 100–450 kHz.[11]

Different regulations have different impact on the communication system. In USA, the larger bandwidth makes it possible to have higher bit-rates. However, in Europe, the bandwidth limitations almost dampen any effort attempting to achieve a higher baud rate in the communication system.

## 8. CHANNEL IMPEDANCE

The characteristic impedance of an unloaded transmission line can be obtained from the standard distributed parameter model as given in [12] for uniform distributed line. Unfortunately, a uniform distributed line is not an appropriate model for power line carrier communication since a number of loads with different impedances are connected to the power lines for variable duration of time. Therefore, the channel impedance is a strongly fluctuating variable, depending on the specific loads connected to the power lines at specific times. Furthermore, since the overall impedance results from the parallel connection of all the networks' loads, small impedances will definitely play a dominant role in determining the overall channel impedance.

However, the overall impedance is found to be very small. Ferreira quote figures of 0–80 $\Omega$  for the low voltage network. Abraham stated that the loaded line impedance lies within the range of 5–150 $\Omega$  while Hooijen reported a very low channel impedance at the residential area. Normally, for conventional communication, impedance matching is attempted, such as the use of 50 $\Omega$  cables and 50 $\Omega$  transceivers. However, the power line network is not matched. The input (or output) impedance varies with time, with different loads and locations. This phenomenon presents significant challenges when designing coupling network for the communication system. Maximum power transfer theory states that the transmitter and channel impedance must be matched for maximum power transfer. However, impedance mismatches can easily occur with the presence of a strongly fluctuating channel impedance.

## 9. NOISE AND FILTERING

On high and medium voltage network, channel noise is primarily caused by lightning, circuit breaker operations, transients produced within a power circuit and on/off switching of capacitor banks used in power factor correction. However, on the notoriously noisy low voltage grid, the noise basically is a summation of four different noise types, as identified by Hooijen and Vines et al, that is, noise synchronous to the power system frequency (Type A noise), noise with a smooth spectrum or background noise (Type B noise), single-event impulse noise (Type C noise) and non-synchronous noise (Type D noise).

Filters of some sort are essential to the operation of most communication systems to emphasize signals in certain frequency ranges and reject signals in other frequency ranges. Such a filter has a gain which is dependent on signal frequency. There are generally five basic filter types: band-pass, band-reject, low-pass, high-pass, and all-pass.

There are three main approaches in implementing filters, namely, passive filters, active filters and switched-capacitor filters. Passive filters are made up of passive components: resistors, capacitors and inductors. A passive filter uses no amplifying elements (transistors, operational amplifiers, etc.). In this respect, it is the simplest form of implementation in terms of the number of necessary components. However, since passive filters use no active elements, they cannot provide signal gain. Active filters use amplifying elements, especially op-amps with resistors and capacitors in their feedback loop, to synthesize the desired filter characteristics. They can have high input impedance, low output impedance, and virtually any arbitrary gain. Switched-capacitor filters have become widely available in monolithic form during the last few years. The switched-capacitor approach overcomes some of the problems inherent in standard active filters, while adding some interesting new capabilities. Switched-capacitor filters need no external capacitors or inductors, and their cutoff frequencies are set to a typical accuracy of  $\pm 0.2\%$  by an external clock frequency. In addition, switched-capacitor filters can have low sensitivity to temperature changes.



## 10. POWER LINE COUPLER

Inductive coupling method is chosen to couple the communications signals onto the power lines since it represents the best compromise between the need for efficiency, convenience, safety and low cost. The most common inductive coupler topology is shown in Figure 5. It uses a serially connected capacitor on the primary of a transformer. The design is based on two principles:

- i) A value of  $C_{eq}$  having a large impedance at 50 Hz to block the line frequency.
- ii) Resonance between the coupling capacitor  $C_{eq}$  and the primary winding inductance  $L_1$  to yield a sufficiently low characteristic impedance.

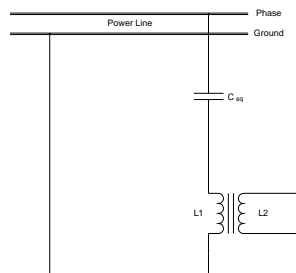

*Figure 5 : General Circuit Diagram of Power Line Coupler*

The major shortcoming of this design has been the use of ferrite or iron core transformer in the signal coupler. The effective primary inductance  $L_1$  is altered to some unknown (nearby) value due to the non-linear characteristic of the core. Alternatively, Abraham and Roy proposed a design to couple the signal onto the power line with a low transceiver input impedance by using a large coupling capacitor (approximately 0.5  $\mu\text{F}$ ). However, the major drawback of this approach is that it results in significant carrier frequency loss.

A better design of a coupling network is obtained by slightly altering Figure 6 by using a double-secondary transformer to obtain Figure 6. This modified coupler network enables further filter design on each of its secondary to achieve the desired frequency response. The transmission secondary can be designed to have high-pass characteristics while having band-pass properties for reception in the secondary.

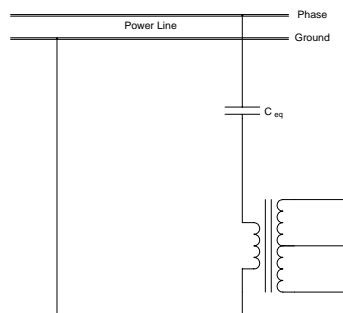

*Figure 6 : Double-Secondary Coupler*

## 11. MODULATION SCHEMES

Several systems have been developed which aim to apply PLC techniques to the problem of remote metering. The choice of modulation system has produced different results. Ramseier et al adopted multi-carrier modulation (MCM) (also known as Orthogonal Frequency Division Multiplex, OFDM or Discrete Multitone, DMT), which combine an excellent bandwidth efficiency (high data rates) with the possibility of a very flexible bandwidth allocation.[13] Dostert managed to apply Frequency-Hopping Spread-Spectrum Modulation (F-H S-S) for digital communications over electrical power lines. Hagmann proposed a spread spectrum communication system for load management and distribution automation in Switzerland. Schaub et al found that the Frequency Shift Keying (FSK) system using a cyclic redundancy check to detect an error and repetitive polling was able to achieve 95.8 to 99.2% communication success.[14] In fact, both Frequency Shift Keying (FSK) and Phase Shift Keying (PSK) are robust yet simple but FSK scheme performs better in a high-phase delay channel. National Semiconductor Corporation concurs with this fact and comes out with several integrated chips (IC) based on FSK scheme.

There is basically no systematic relation between the frequency and the signal attenuation on the power line channel. It is therefore impossible to determine beforehand a best transmission frequency for a communications network. The well-known Amplitude Modulation (AM) technique can be modified to shift the base band frequency of the FSK waveform to different carrier frequencies, creating a reliable frequency diversity scheme.

## 12. BUILDING THE AMR SYSTEM

The AMR system consists of three primary components, namely, the meter interface module, communication system as well as the central control unit or data concentrator, which is used to store the transmitted meter readings data. For the meter interface module, the functional building block is an electro-mechanical meter with an electro-optical interface that must be incorporated into or attached to the meter. This modification converts information conveyed by the meter's mechanical register indexes, or dial readings, into electronic signals, which may be processed, manipulated, stored and transmitted. This meter interface is also known as the Remote Transmit Unit or RTU and are termed as the end-units for a central control unit.[15] As most of the system's intelligence is placed upstream at the customers' meters, there exists a controller unit consisting of a low-voltage power supply, signal processing electronics, microcomputer, random access memory and program memory used to store the real-time run or operating system program. The controller unit is used to press the signals originating from the meter's electro-mechanical or electro-optical interface device. In effect, the controller unit converts the meter's electro-mechanical interface device signals into computer type electronic digital representations of the meter's exact index or dial readings. The controller's RAM memory maintains an up-to-the-minute mirror image of the meter's dials and as the dials increment, so do the numerical representations stored in RAM.

The second functional building block is the communication scheme and its associated transmit and receive electronics. Generally, meter-to-utility host communication uses one or more transmission techniques, namely, telephone, power line carrier, radio frequency through the airwaves, or television cable. In this paper, the power line carrier or PLC is chosen as the communication scheme.

Once usage data travels from the meter through the gateway and across the communication network, the computer system at the central office or master station is responsible for accumulating and processing the information before sending it to billing and other departments. Thus, the third functional block is the central control unit and consists mainly of the data concentrator, which is a microprocessor or computer and a

central controller. The data concentrator is a compact computer-type electronic unit, located at an easily accessible point, for remotely coordinating the end-units installed in the meters, processing the data received from the end-units and receiving, transmitting and handling transmissions to and from the utility's central computer. At some convenient point in the power network, a data concentrator takes overall control of the many thousands of meters under its charge.

The data concentrators, of which there are relatively few, communicate with a central controller that functions as the overall system manager, based at the utility company's headquarters or data processing center. The communication links for transfer of data to the central controller can use any convenient medium, such as, ISDN, PSTN, radio, dedicated wires, optics-optics and microwave. Also, the central controller can be interfaced to other IT system, customer information system as well as plant and asset register.

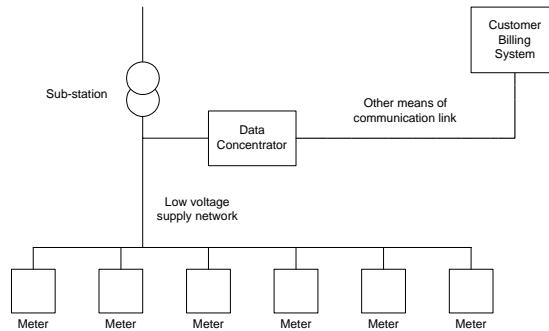

Figure 7 : AMR System

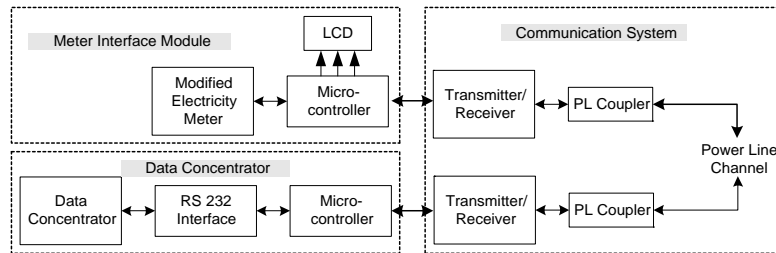

Figure 8 : Project Overview

## MAJOR PARTS OF AMR

### 13. METER INTERFACE MODULE

The AMR system starts at the meter. Some means of translating readings from rotating meter into digital form is necessary in order to send digital metering data from the customer site to a central point. In most cases, the meter that is used in an AMR system is the same ordinary meter used for manual reading. This type of meters is known as the electro-mechanical or Ferraris' disc meter. Alternatively, an electronic meter that functions based on sold-state electronic technology can be also utilized. The internal mechanism used for metering consumption differs for both these cases. The main difference is the addition of some device to generate pulses relating to the amount of consumption monitored, that is, the generation of electronic digital codes that translates to the actual reading on the meter dials for the case of the electro-mechanical meter.

After conversion of the electro-mechanical meter, the register dial will no longer be utilized and is taken out of the system. In place of it, with the generation of the digital pulses, an LCD display is used. LCD is chosen because it gives clear read-outs, is easy to implement and controlled using a PIC microcontroller and most importantly, it reads data in digitalized ASCII code. Thus, the PIC microcontroller can take the digital pulses emitted from the converted electro-mechanical meter, count them and lastly, convert them to ASCII code to be transmitted for display on the LCD.

In this paper, conversion of an electro-mechanical paper is preferred to the utilization of an electronic meter for economic reasons as it is cheaper to just install PIC microcontroller chips on the existing traditional electro-mechanical meters as compared to changing all the old meters and obtaining new electronic meters. Also, the total cost of conversion is much cheaper than to purchase a new electronic meter.

The most important aspect when using an electro-mechanical meter to perform AMR function is to convert the meter such that instead of being an analogue meter that detects electricity readings based on signal detection of the continuously rotating Ferraris' disc, it has to become a digitalized meter that detects signal in the form of digitized pulses. The digital pulses can be obtained through the combination of an optical encoder and a PIC microcontroller, whereby, the optical encoder converts the analogue readings of the rotating electro-mechanical meter into digitized pulses while the PIC microcontroller reads, counts and records the number of digitized pulses as meter readings. The data detected by the PIC microcontroller is stored in its RAM and is sent out across the power lines after every 15 minutes. Therefore, to achieve this purpose, a LM555 timer has to be used. In the time delay mode of operation, one external resistor and capacitor precisely control the time. Its timing can range from microseconds through to hours. A time delay of 15 minutes is set to trigger the PIC microcontroller to send the accumulated meter readings over the PLC. The LM555 timer circuitry is as shown in Figure 9.

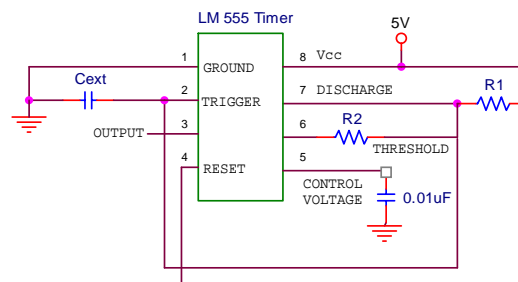

Figure 9: The LM 555 Timer Circuitry

The values for both resistors,  $R_1$  and  $R_2$  as well as the external capacitor,  $C_{ext}$ , are govern by Equations 3 and 4:

$$f_r = \frac{1.44C_{ext}}{(R_1 + 2R_2)} \dots\dots\dots(1)$$

$$\begin{aligned} \text{Duty Cycle} &= \frac{t_H}{(t_H + t_L)} \dots\dots\dots(2) \\ &= \frac{(R_1 + R_2)}{(R_1 + 2R_2)} \times 100\% \end{aligned}$$

The duty cycle gives an indication of the ratio or percentage of a full period of the output rectangular waveform where the signal is High and  $f_r$  is the frequency of oscillation for the rectangular output waveform. The duty cycle is controlled by the values of the two resistors,  $R_1$  and  $R_2$ . Ideally, we want the duty cycle to be 50 % (ratio value = 0.5) or thereabouts. However, the resistors,  $R_1$  and  $R_2$  together with the external

capacitor,  $C_{ext}$ , also determines the frequency of oscillation of the rectangular output waveform, which in turn also determines the timing provided by the LM555. Thus, proper calculations and determination of these three variables of  $R_1$ ,  $R_2$  and  $C_{ext}$  are essential to provide proper timing that enables data to be sent across the PLC at intervals of 15 minutes. The values calculated are  $R_1 = 30k\Omega$ ,  $R_2 = 8.2 M\Omega$  and  $C_{ext} = 0.3082\mu F$ .

A side function for an AMR system is the provision for remote connection and disconnection of meters. This is an important function especially for meters at abandoned buildings and residences, so that the power supply can be cut off from these meters automatically and remotely from the utility company's office. This will ensure a significant savings in labor time and costs and improve the efficiency of the utility company's operations. Also, automatic cutting off of power supply to the meter can be implemented to belligerent households that refuse to pay their mounting debts with the utility company if legally they are entitled to do so according to local statutes.

To produce supply to the meter, a power relay is used. An important criterion in the selection of this particular type of relay is its ability to withstand a large amount of load current, where, the load current entering into the meter from the outside power lines can reach up to 30A. This relay is placed outside the meter at the live cable. The power relay acts as a switch for the current flow into the meter. The power relay used is of the type N/C or Normally Closed, that is, current is allowed to pass through the relay into the

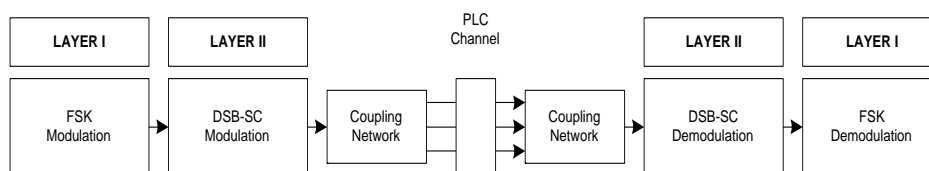

electro-mechanical meter under normal conditions. When the relay is triggered, it will open and current is blocked from entering into the meter, that means, the meter has been disconnected from the power grid. The circuit for the BJT transistor that enables the power relay to be cut off is shown in Figure 10.

*Figure 10 : Transistor Circuitry For Power Relay*

Thus, by sending a control signal from the data concentrator to the particular meter, automatic disconnection of the meter can be done by triggering the N/C power relay to open and to block the power supply from reaching the meter. To reverse this process, another control signal is sent from the data concentrator to close the N/C power relay to enable power supply to reach the meter again.

Another feature of the AMR is the ability to detect fraud or tampering of the converted electro-mechanical meter. Detection of fraud can be done in two ways; one at the meter interface side while the other is done at the data concentrator or computer side. At the meter interface side, detection of tampering is implemented through the use of a motion or vibration sensor. The motion sensor is placed at the covering of the electro-mechanical meter. Therefore, if an attempt to tamper the converted electro-mechanical meter is made, the covering of the meter has to be opened first. Alternatively, a very small hole can also be drilled without opening the cover. Either way, when the covering is being tampered, the vibration of the meter covering will ensure that the motion sensor is activated such that it triggers the PIC microcontroller to inform it of the occurrence of fraud.

As a support system to the entire AMR system and especially to the LCD, batteries are utilized. They are especially important in the cases of power failures and power disruptions that can cause the entire AMR system to break down and the LCD to lose its stored memory and reading. Presently, power for the AMR system is drawn from the power lines using standard down-transformers but when power disruption happens, no power will be supplied to the entire AMR system. The selection of lithium-ion batteries as the type of batteries that are used is the fact that these batteries tend to last longer than most other batteries, even up to 10 years. Also, lithium batteries are light and have a high energy density. In addition to that, it contains no mercury, cadmium nor lead and therefore, is non-poisonous. However, lithium batteries are more expensive than most other batteries.

## 14. COMMUNICATION CHANNEL

Figure 11 shows the modulation scheme implemented for successful transmission of data between the meters and the data concentrator. It is a two-layer modulation scheme incorporating both FSK modulation as well as DSB-SC modulation for more effective transmission of data across the noisy power lines.

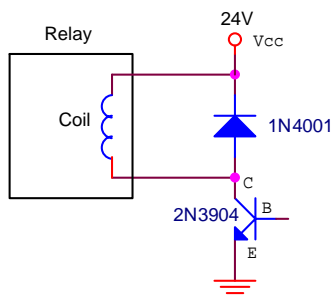

*Figure 11 : Block Diagram of the Modulation System*

Frequency Shift Keying (FSK) is chosen to be the first layer modulation method not only for its excellent impulse noise rejection, but also for the simplicity of implementation in both the transmitter and receiver sections. This can be done by the application of a monolithic function generator integrated circuit easily obtainable in the market.

Layer two is designed to enhance the performance of the basic communication system under excessive interference, enabling the system to recognize and avoid frequency bands where excessive interference exists. The only constraint needs to be taken into account is the available narrow bandwidth (3-95 kHz). The use of DSB-SC in second layer further introduces the concept of frequency hopping. Frequency hopping (FH) scheme is well known for its ability to make the communication link robust. Communication-wise, it has a great immunity on jamming and minimized the danger of interference. Without FH, in the basic band of the transmission, a certain bandwidth is used. However, due to the ability to change the carrier frequency, the method of frequency hopping can fully utilize the bandwidth allocated by CENELEC, i.e. Band A of 3-95 kHz. Each change in carrier frequency is called a hop.

The first step is to decide which carrier frequencies should be adopted in such a harsh environment, taking into consideration the measurements and research outcomes done by various people from various countries. The major constraint is that these frequencies must reside within the CENELEC EN50065.1 A-Band range. At last, the band from 20-95 kHz appears to be optimum as a trade-off between noise, propagation and coupling losses. The carrier frequencies are allowed to hop freely in this particular band. The second step is to set all selected carrier frequencies at odd multiples of half the power frequency. This is because 50 Hz harmonics will all be at even multiples of 25 Hz. This means that the carrier is precisely

located between a pair of harmonics and therefore the detrimental Type A noise (noise synchronous to the power system frequency) can be effectively avoided.

Passive filters are used extensively for several prominent reasons. Firstly, passive filters are easy to implement, require no power supplies and since they are not restricted by the bandwidth limitations of op-amps, they can work well at very high frequencies. They can be used in applications involving larger current or voltage levels than can be handled by active devices. Passive filters generate little noise when compared with circuits using active gain elements. The noise they produce is simply the thermal noise from resistive components, and, with careful design, the amplitude of this noise can be very low.

## 15. DATA CONCENTRATOR

To connect the external electronic circuitry to the computer, a standard called the RS-232 standard is adopted. The RS-232 interface uses negative logic levels. There are many languages that can be used to program the software at the data concentrator side such as C, Fortran, Basic and many others. Also, there are many software programs that can be used like Borland C++, Visual Basic and Visual C among them. The software program chosen to be used here at the data concentrator side of the AMR system is the Visual Basic Version 6.0 software. This particular language is chosen for the simple reason that it is the easiest to be implemented for the purpose of communicating with the computer's serial port.

Furthermore, as timing is critical here since the exact moment that the meter readings are sent has to be accurately recorded, the Visual Basic software provides another advantage as it can display the internal computer system clock on the PC screen easily. Thus, comparison can be made to observe the pattern of data of the meter reads from each meter to check for any anomaly or deviation and to warn the user when excessive electricity usage is used.

## 16. TESTING AND DISCUSSION

The Visual Basic language will enable the following to be shown on the computer screen when the Meter Reading Program is executed. Firstly, the Splash program form will be shown as in Figure 12.



*Figure 12 : The Splash Screen*

A password will be requested and the user of the software is requested to key in his/her identity (ID). Thus, only authorized personnel can have access to the software program and unauthorized users will be denied access when an invalid password is keyed in as shown:

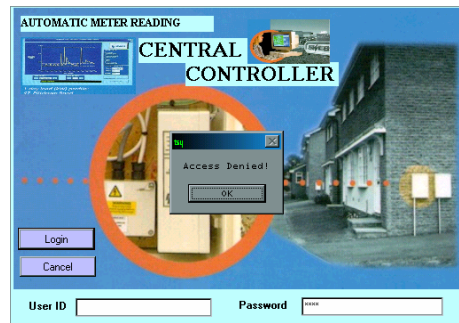

*Figure 13 : Access Denied*

For authorized personnel of the utility company, after the correct password has been entered, the next screen will request the user to select the appropriate meter region of interest from a pull-down list as shown.

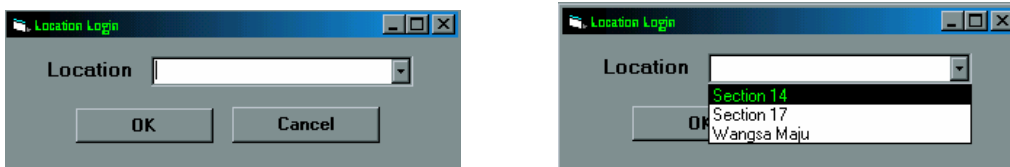

*Figure 14 : Selection Of Meter Region*

After the selection of the desired meter locations, the software program will run and wait for the meter reads from the meter to reach the data concentrator. A sample data during the testing of the AMR system after the lapse of some time to allow some meter reads from two meters to reach the data concentrator is shown next.



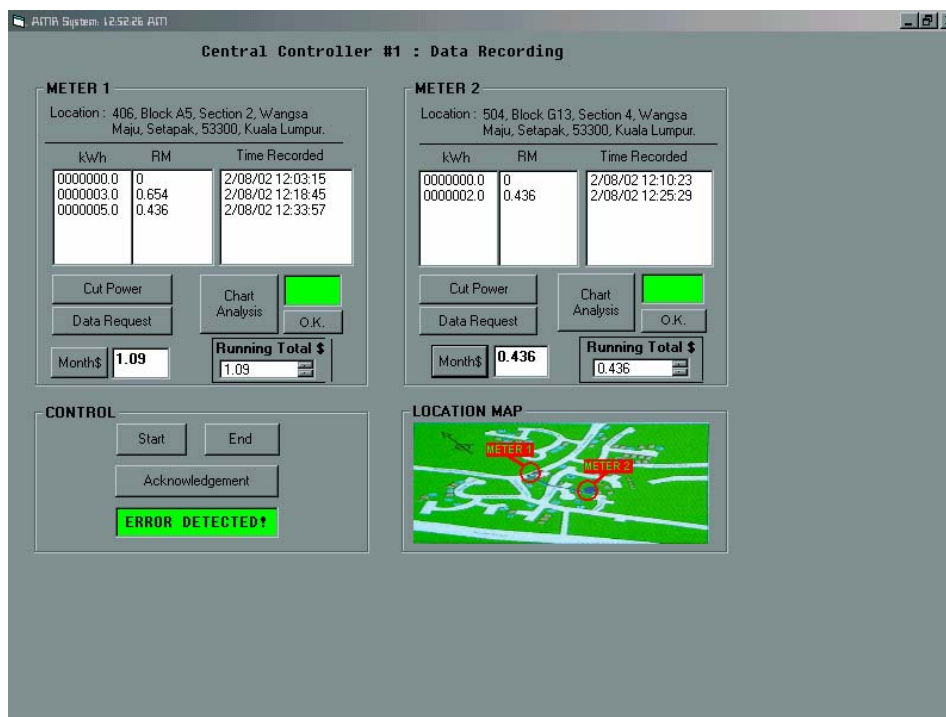

*Figure 15 : Readings Shown on the Main Screen During Testing*

As seen from Figure 15, the conversion from the meter readings in the unit of kWh to the equivalent money value can be calculated directly through the software program. Also, the above program can request for data of meter reads to be sent from selected meters and disconnection of selected meters. It can also receive tampering messages from the meters whereby the green patch in the associated meter column turns from green to red. When the color changes after tampering signal is received, a 'beep' sound is also emitted to alert the program user

During initial testing, sometimes very odd data was obtained at the data concentrator. Therefore, we decided to incorporate some error detection signal on the Visual Basic program in Figure 15.

A number of schemes can be used to perform the functions of error detection and error correction. When asynchronous transmission is used, since each character is treated as a separate entity, an additional binary digit or bit is embedded within each transmitted character. This additional digit is known as the parity bit. This scheme allows the receiver to detect the occurrence of transmission errors only. Consequently, a scheme is needed to enable the receiver to obtain another copy of the original transmission when errors are detected. A number of schemes are possible, whereby; one way is to implement the frequency-hopping technique. With this technique, the data is retransmitted to the receiver side across the PLC by using a different frequency from its original one. This is the error control scheme.

In our AMR system, the most common error detection method is implemented, namely, parity bit error detection. An extra ninth bit will be appended at the end of the 8-bit ASCII code (the code used to transmit data is the ASCII or American Standards Committee For Information Interchange) representing the parity bit. In the scheme used, even parity is used, that is, the total number of binary 1s in the character or byte including the parity bit has to be even (namely, 0,2,4,6 or 8). A parity bit of 1 is inserted if the character has sum of binary 1 that is odd and a parity bit of 0 is inserted if the character has sum of binary 1 that is even to ensure that the total sum of binary 1 is always even for the generated parity and the character or byte ASCII code combined. The detection of the sum of binary 1 is done by the PIC micro controller and once error has been detected, the PIC micro controller will request the meter to resend its data using a different frequency (frequency-hopping scheme) while the 'Error Detected' portion on the screen of the Visual Basic program (Figure 15) will change color from green to red.

Figure 16 is the Chart Analysis program that shows the wave shape of power consumption of a particular meter. This program can be obtained from the main screen by clicking on the “Chart Analysis” button for the required meter (Figure 15). The importance of Chart Analysis is to detect the tampering of meters at the data concentrator side. Observing the shape of the line graph obtained can do this. A straight or fairly straight line indicates that the meter data reads are consistent at the fixed intervals of 15 minutes and therefore, there is no suspicion of meter tampering. However, when the line plot suddenly ‘shoots up’ to a very high value or increases by a very small value only at regular intervals of 15 minutes when compared with the previous 15-minute intervals, this will give rise to a strong suspicion of meter tampering at the meter concerned. Thus, the utility company can carry out investigations to verify the suspicion of meter tampering at the said meter. Requesting the meter concerned to send its meter readings by clicking on the ‘Data Request’ button can do this. If the meter read data still show inconsistent values, thus, the suspicion of tampering is confirmed and the utility company can take appropriate action.

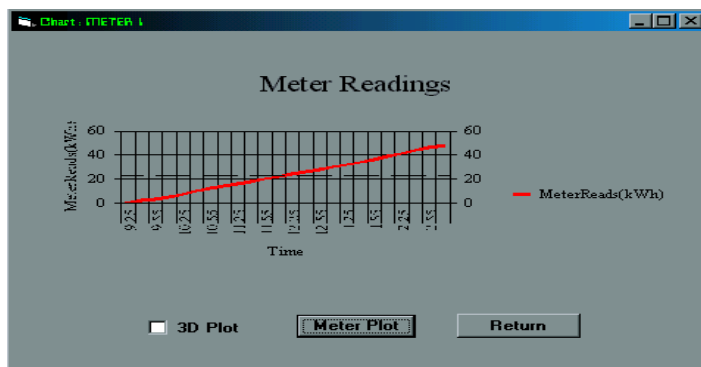

*Figure 16 : Chart Analysis Screen*

When the ‘End’ button of the main screen (Figure 15) is clicked, it signifies the end of the session and the following will be shown on the computer screen.

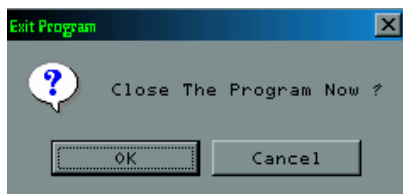

*Figure 17 : Exiting AMR Software Program*

When ‘OK’ is selected, the software program will be closed and a new meter region can be selected when the program is executed again

The results of the test run that was conducted were satisfactory with a low percentage of error. The meter readings of the LCD and the meter readings obtained at the data concentrator are identical. Furthermore, the control functions of meter tampering detection and remote connection and disconnection of power supply to the meter can be performed for each individual meter, each having its own address, detected by the PIC micro controller.

## 17. CONCLUSION

The AMR system constructed have two-way communication functions to enable communication between the data concentrators with the meter interface modules. The selected medium of communication is the power line carrier, PLC, since the infrastructure already exist and the PLC belongs to the utility companies. Furthermore, the electricity meters were given all the attention in this paper while other meters like water meters and gas meters were not discussed. Gas meters are rarely found in Malaysia and since the discussion here concerns the PLC as the communication link, further conversion of water meters are needed such that they are enabled to transmit meter readings over the power lines. Thus, they are not discussed here but a further extension to the AMR project may include the combination of the three meters such that all the meter readings from these meters can be sent across the PLC together.

A robust system for communicating over low voltage power lines has been built and tested, combining the advantages of FSK and frequency diversity with very satisfactory results. The combination of software and hardware is able to successfully create a more robust communication system. Furthermore, through clever conversion of existing electro-mechanical meters, an inexpensive AMR system was successfully implemented. Although the cost is low, the results are nevertheless quite accurate. Also, various functions such as meter tampering detection as well as remote connection and disconnection of meter were successfully built into the AMR system.

## 18. REFERENCES

- [1] Eyre, B. E., "Results of A Comprehensive Field Trial of A United Kingdom Customer Telemetry System Using Mains Borne Signaling", Proceedings of the Sixth International Conference on Metering Apparatus and Tariffs for Electricity Supply, IEE Conference Publication no. 317, 1990, pp. 252-256
- [2] Baker, M., "Added Value Services Through the Use of AMR in Commercial and Industrial Accounts", in Conference on Metering and Tariffs for Energy Supply, 25-28 May 1999, pp. 210-212
- [3] Tamarkin, T. D., "Automatic Meter Reading", Public Power, Vol. 50, No. 5, September-October 1992.
- [4] Haggmann, W., "A Spread Spectrum Communication System for Load Management and Distribution Automation", IEEE Transactions on Power Delivery, Vol. 4, No. 1, January 1989, pp. 75-81
- [5] Ferreira, H. C., Grove, H. M., Hooijen, O., & Han Vinck, A., "Power Line Communications: An Overview", Vol. 2, 1996, pp. 558-563.
- [6] Nunn, C., Moore, P. M., & Williams, P. N., "Remote Meter Reading and Control Using High-Performance PLC Communication over the Low Voltage and Medium Voltage Distribution Networks", in 7<sup>th</sup> International Conference on Metering Apparatus and Tariffs for Electricity Supply, 1992, pp. 304-308
- [7] Hooijen, O. G., "A Channel Model for the Residential Power Circuit Used as a Digital Communications Medium", IEEE transactions on Electromagnetic Compatibility, Vol. 40, No. 4, November 1998, pp. 331-336.
- [8] Dostert, K. M., "Frequency-Hopping Spread-Spectrum Modulation for Digital Communications over Electrical power Lines", IEEE Journal on Selected Areas in Communications, Vol. 8, No. 4, May 1990, pp. 700-710.
- [9] Vines, R. G., Trussell, H. J., Gale, L.J., & O'Neal, J. B., "Noise on Residential Power Distribution Circuits", IEEE Transactions on Electromagnetic Compatibility, Vol. EMC-26, No. 4, November 1984, pp. 161-168.
- [10] Newbury, J., "Communication Requirements and Standards for Low Voltage Mains Signaling", IEEE Transactions on Power Delivery, Vol. 13, No. 1, January 1998, pp. 46-52.
- [11] Monticelli, D. M., & Wright, M. E., "A Carrier Current Transceiver IC for Data Transmission over the AC Power Lines", IEEE Journal of Solid-State Circuits, Vol. SC-17, NO. 6, December 1982, pp. 1158-1165.
- [12] Abraham, K. C., & Roy, S., "A Novel High Speed PLC Communication Modem", IEEE Transactions on Power Delivery, Vol. 7, No. 4, October 1992, pp. 1760-1768.
- [13] Ramseier, S., Arzberger, M., & Hauser, A., "MV and LV Powerline Communications: Proposed IEC Standards", In IEEE Transmission and Distribution Conference, Vol. 1, 1999, pp. 235-239

- [14] King, M. C., Adame, J., Schaub, T., Rossi, G., & Ziglioli, F., “Experimental Systems for Tele-Reading over the Low Voltage Network”, In 6th International Conference on Metering Apparatus and Tariffs for Electricity Supply, 1990, pp. 154-157
- [15] Golinsky, E., “Bi-Directional Communication for Remote Metering and Sophisticated Tariffication”, in 7<sup>th</sup> International Conference on Metering Apparatus and Tariffs for Electricity Supply, 1992, pp. 228-232