



Empirical Mode Decomposition based Adaptive Filtering for Orthogonal Frequency Division Multiplexing Channel Estimation

E. Hari Krishna^a, K. Sivani^b, K. Ashoka Reddy^{*c}

^aElectronics and Communication Engineering Department, University College of Engineering, Kakatiya University, Kothagudem, Telangana, India

^bElectronics and Instrumentation Engineering Department, Kakatiya Institute of Technology & Science, Warangal, Telangana, India

^cElectronics and Communication Engineering Department, Kakatiya Institute of Technology & Science, Warangal, Telangana, India

PAPER INFO

Paper history:

Received 07 June 2017

Received in revised form 15 July 2017

Accepted 12 August 2017

Keywords:

Orthogonal Frequency Division Multiplexing

Multi Carrier Channel Estimation

Adaptive Filtering

Empirical Mode Decomposition

Multipath Fading Channel

ABSTRACT

This paper presents an empirical mode decomposition (EMD) based adaptive filter (AF) for channel estimation in OFDM system. In this method, length of channel impulse response (CIR) is first approximated using Akaike information criterion (AIC). Then, CIR is estimated using adaptive filter with EMD decomposed IMF of the received OFDM symbol. The correlation and kurtosis measures are used to select the useful IMF component from among available IMFs. Conventional AF uses random initial weight vector. The novelty of the proposed method is that it uses decimated version of one of the decomposed IMFs of received OFDM symbol as initial weight vector. This makes the proposed EMD based AF method converge to minimum mean square error (MMSE) in less number of iterations resulting in almost 50% saving of computations. The simulation studies in terms of bit error rate (BER) and mean square error (MSE) calculations established the efficacy of proposed method; and comparative studies under different modulation schemes and fading conditions revealed improved performance.

doi: 10.5829/ije.2017.30.10a.13

1. INTRODUCTION

In present day scenario there has been a vast demand for high data rate wireless communication system and that demand is increasing continuously. On similar lines, the research is also progressing. One of the key technologies which started its birth in 3G communication and continuing its existence with modifications to till latest 5G wireless standards is orthogonal frequency division multiplexing (OFDM). The principal advantage OFDM is that it provides high resistance to inter symbol interference (ISI) caused by the high data rate systems over a non-linear frequency selective channel [1-3]. OFDM uses the basic PSK, QAM constellations, the modelling and simulation of QAM is presented in [4]. Vast applications of OFDM includes wireless LAN, Wi-Fi and WiMAX standards with a provision of high speed multimedia transmission.

*Corresponding Author's Email: kareddy.iitm@gmail.com (K. Ashoka Reddy)

A MIMO antenna system and its suitability for long term evolution (LTE) LAN is illustrated in [5] with good simulation study. At early days of OFDM wireless transmission system, the channel estimation was performed using pilot symbols with different interpolation techniques [6-8]. Different pilot structures were developed, but these methods transmit training symbols in addition to the original data symbols, which reduces the efficiency of the system. The least squares (LS) estimator and minimum mean square error (MMSE) estimators were developed in the literature for OFDM channel estimation (CE) [9]. For performance enhancement of LS or MMSE estimator, discrete Fourier transform (DFT) based method was established, which leads to reduction of out of band noise [10]. The decision directed CE method [11] will not use pilot symbols, once the initial CE has been completed. In this technique, if any error occurs in initial CE stage, the same will be propagated to later stages, leading to reduced performance and further degradation takes

Please cite this article as: E. Hari Krishna, K. Sivani, K. Ashoka Reddy, Empirical Mode Decomposition based Adaptive Filtering for Orthogonal Frequency Division Multiplexing Channel Estimation, International Journal of Engineering (IJE), TRANSACTIONS A: Basics Vol. 30, No. 10, (October 2017) 1517-1525

place if the variation of channel coefficients are faster compared to OFDM symbol period.

A simple method for CE [12] was developed by adding low power training signals to the data symbols, while ensuring that the system data rate is not reduced. In general, for fast varying channels, the wireless channel will disturb the orthogonality property of OFDM scheme among the subcarriers which leads to inter channel interference (ICI). Expectation maximization [EM] [13] is an iterative method which finds the maximum likelihood of the channel impulse response (CIR) coefficients. A discrete partial Fourier transform (DPFT) based CE method was developed with compressive sensing of input signal [14]. Cimini et al. [15] discussed the issues related to all the established CE methods and open their challenges. Iterative CE based on Wiener filtering [16] requires computationally complex calculations in addition to knowing the channel characteristics at receiver side. The convergence analysis of least mean square (LMS) and sample matrix inversion (SMI) with its optimization capabilities for smart antenna systems was presented in [17]. The methods like an adaptive filter based OFDM CE [18], a blind CE using low order constellation [19], and low rank approximation OFDM for CE [20] made attempts to make the CE process more accurate. Comparative measure such as bit error rate (BER) was made as standard for evaluation of digital communication systems over different multipath fading channels [21]. In this work, a signal processing method using empirical mode decomposition (EMD) [22] based adaptive filtering (AF) for OFDM channel estimation is presented.

2. WIRELESS TRANSCIEVER MODEL USING OFDM

Here, in this work the modulation schemes such as BPSK, QPSK, 16 QAM, 64 QAM and 256 QAM were

considered as per IEEE 802.11 acTM standards [23]. As shown in Figure 1, wireless transceiver using OFDM modulates the input binary sequence $b_T(n)$ onto PSK/QAM mapper $[F(k)]$ and then performs IFFT on parallel converted data.

$$f(n) = \sum_{k=0}^{N-1} F(k) e^{j2\pi nk/N}, n=0,1,2,\dots, N-1 \quad (1)$$

N is the number of sub carriers. Before transmission onto wireless medium, the cyclic prefix (CP) is added to ensure zero ISI $[f_{cp}(n)]$ and then it is converted to analog domain.

The received signal at OFDM receiver can be written as:

$$y_R(n) = f_{cp}(n) \otimes h_{CIR}(n, k) + g(n) \quad (2)$$

\otimes symbol indicates the convolution; $g(n)$ is the additive white Gaussian noise (AWGN) with zero mean and unit variance; $h_{CIR}(n)$ is the wireless multipath fading time varying CIR to be estimated and it is modeled as:

$$h_{CIR}(n, k) = \sum_i \alpha_i(n) w(n - k_i) \quad (3)$$

k_i is the delay incurred during the i^{th} path component, $\alpha_i(n)$ corresponding attenuation and $w(n)$ impulse response coefficient in the same i^{th} path. After removing the CP, the processed OFDM symbol is passed through FFT block as given below.

$$Y_R(k) = F_{cp}(k) H_{CIR}(k) + G(k) \quad (4)$$

where, $Y_R(k)$, $F_{cp}(k)$, $H_{CIR}(k)$ and $G(k)$ are N -point FFT of received OFDM symbol ($y_R(n)$), transmitted OFDM symbol ($f_{cp}(n)$), the channel CIR ($h_{CIR}(n)$) and Gaussian noise ($g(n)$).

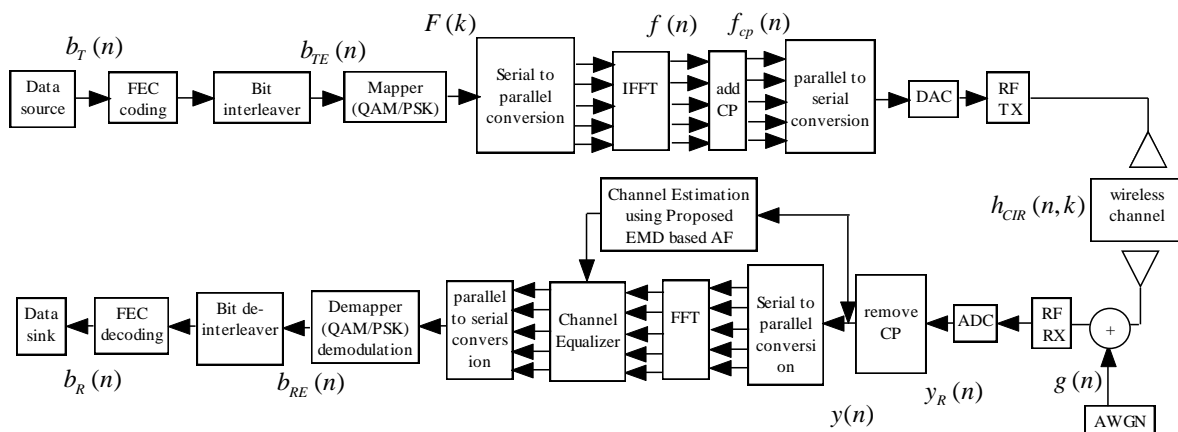

Figure 1. Block diagram of wireless Transceiver system [24]

To recover the original transmitted binary sequence, the time varying CIR is to be estimated properly with use of some novel signal processing method.

3. EMD BASED ADAPTIVE FILTER FOR ESTIMATION OF CIR

3.1. Empirical Mode Decomposition A simple and efficient EMD method proposed by N. E. Huang is an adaptive time-frequency analysis method [22].

It decomposes a given signal $f(n)$ into a set of AM-FM components, called intrinsic mode functions (IMFs). The resulting L modes $I_i(n)$ and a residual term are expressed as:

$$f(n) = \sum_{i=1}^L I_i(n) + r(n) \tag{5}$$

The various steps of EMD algorithm are summarized in the flowchart shown in Figure 2.

3.2. Adaptive Filtering AF uses a feedback mechanism to self-adjust the impulse response coefficients by means of an optimizing algorithm [25]. The Least Mean Square (LMS) algorithm, first developed by Widrow and Hoff, is widely used due to its computational simplicity. The LMS algorithm is described by the following iteration equations:

$$y(n) = \sum_{i=0}^{N-1} W_i(n)X(n-i) = W^T(n)X(n) \tag{6}$$

$$y(n) = \sum_{i=0}^{N-1} W_i(n)X(n-i) \tag{7}$$

$$e(n) = d(n) - y(n) \tag{8}$$

$$W(n+1) = W(n) + \mu e(n)X(n) \tag{9}$$

where $y(n)$ is the output of AF, $W(n)=[W_0(n), W_1(n), \dots, \dots, W_{N-1}(n)]^T$ the weight coefficient vector of AF, $X(n)=[X(n), X(n-1), \dots, \dots, X(n-N+1)]^T$ the input vector, n the time index, M the order of filter, $d(n)$ the desired output, $e(n)$ the error signal, and μ the step-size; superscript T denotes Hermitian transposition.

3.3. EMD based Adaptive Filtering for CE A signal processing method with less number of computations is always desirable in real time applications. In this direction, a novel empirical mode decomposition (EMD) based adaptive filtering (AF) is developed here for OFDM channel estimation (CE). Different multipath fading channels are considered. In general, conventional AF uses random initial weight vector, whereas the proposed EMD based AF uses the initial weight vector derived from selected decimated decomposed intrinsic mode function (IMF) of received OFDM symbol, which forms the basis for the novelty of the proposed method. Because of attractive properties of EMD, i.e. the basis function of iterative decomposition process derived from the received OFDM symbol, the process of adaptation and consequently the estimation of CIR becomes simple.

The proposed EMD based adaptive filtering is shown in Figure 3. The received OFDM symbol $y(n)$ (i.e. after removal of CP) is given as input to two blocks, one is length estimator using Akaike information criterion (AIC) and another is EMD block. AIC is a way of selecting the model from different set of models [26, 27]. The chosen model is the one that minimizes the Kullback-Leibler distance between the model and the truth. It is based on information theory, but a heuristic way to think about it is as a criterion that seeks a model that has a good fit to the truth but few parameters. It is defined in maximum likelihood sense as:

$$AIC(M) = 2K - 2\ln(\ell(\hat{\theta}/y)) \tag{10}$$

where K is the number of free parameters in the model. $\ln(\ell(\hat{\theta}/y))$ is the log likelihood function.

$$AIC(M) = 2K + \ln(RSS) \tag{11}$$

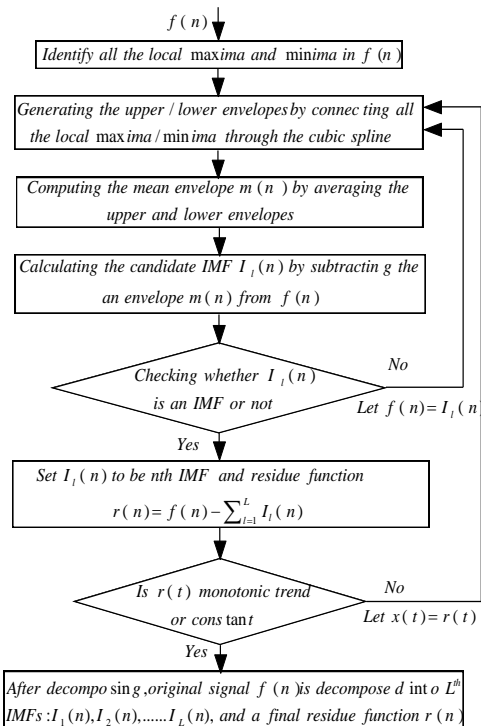

Figure 2. Flowchart indicating processing steps of EMD

RSS is residual sum of squares [22]. This minimization is in least square sense. AIC is calculated for different values of M , the M for which AIC is minimum is taken as channel length.

The EMD block decomposes the received OFDM symbol into different (AM-FM) L number of intrinsic mode functions (IMF); the number of IMFs depends on the maxima and minima of the resulting signal. The beauty of the EMD algorithm is that it derives the basis function required for decomposition from the signal itself.

$$y(n) = \sum_{l=1}^L I_l(n) + r(n) \quad (12)$$

To select important IMF from among the available IMFs, the Pearson correlation coefficient is calculated between received OFDM symbol and all individual IMFs and kurtosis is calculated for individual IMFs;

$$k_u = \frac{E(x - \mu)^4}{\sigma^4} - 3 \quad (13)$$

where μ is the mean of x , σ is the standard deviation of x . Kurtosis is considered for estimation of randomness in the individual IMF's. If some periodic component is present in the IMFs, then the Kurtosis value will be closer to zero, otherwise the value will be higher. The fact here is that, at OFDM transmitter side the individual bits are multiplied with periodic subcarriers, which motivated us to use kurtosis in selection of IMFs.

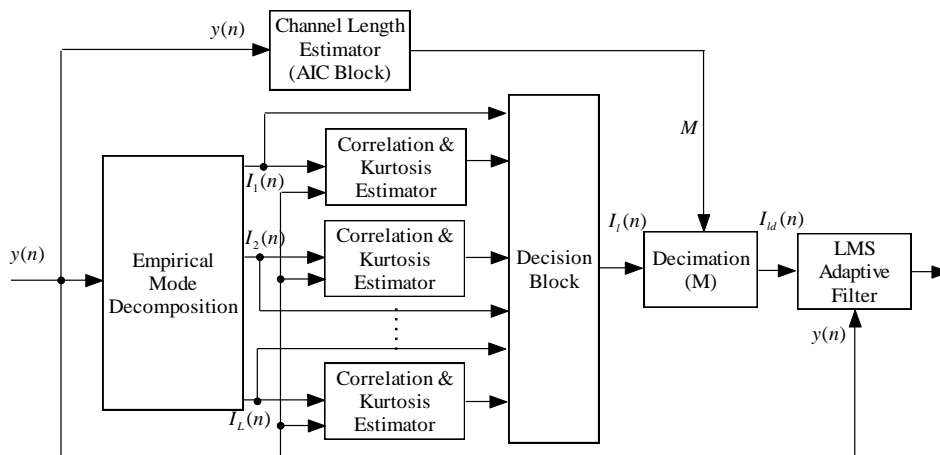

Figure 3. Block diagram of proposed EMD based adaptive filtering

Based on this high degree of correlation and best possible kurtosis values, one of the IMFs is selected. Selected IMF $I_l(n)$ is decimated to a level which is equal to the length of the CIR as estimated by the AIC.

$$I_{id}(n) = I_l(nM) = \sum_{k=-\infty}^{\infty} h_{aaf}(k) I_l(n-k) \quad (14)$$

Here, $h_{aaf}(k)$ is anti-aliasing low pass filter; Now this decimated IMF i.e., $I_{id}(n)$ serves as initial impulse response for the AF. This makes the proposed method different from the conventional AF, which uses random initial weight vector. Finally, the proposed AF optimizes the error performance surface in terms of minimizing the MSE. The converged weight vector of this AF, after good number of iterations, will be the best estimate of CIR.

Conventional AF uses random initial weight vector. The novelty of the proposed method lies in the fact that it uses decimated version of one of the decomposed IMFs of received OFDM symbol as initial weight

vector. The selection of useful IMF component is based on correlation and kurtosis measures. Hence, it is expected that the proposed EMD based AF method converges to minimum mean square error (MMSE) in less number of iterations.

4. RESULTS AND DISCUSSION

The channel impulse response (CIR) estimation will be performed from the received OFDM symbol. In fact, the wireless medium with non-linear time varying characteristics modifies the transmitted symbol in a random fashion under severe fading conditions. The received OFDM symbol represents the variations in CIR which is to be estimated by using a suitable signal processing algorithm. The EMD, in fact, decomposes the signal into a set of AM-FM components called intrinsic mode functions (IMFs). These IMFs represent the varying frequency components present in the unknown signal. This motivated us to use EMD to

extract the inherent components present in the received OFDM symbol for use in the proposed EMD based AF for CE.

To evaluate the performance of the proposed EMD based adaptive filtering, the following simulation parameters with Rayleigh and Rician fading channel are considered given below in Table 1.

The received symbol is shown in Figure 4. Received OFDM symbol passes through EMD block, and their corresponding IMF components are shown in Figure 5. Pearson correlation between decomposed IMF with that of received OFDM symbol and kurtosis of decomposed IMF is evaluated and tabulated as shown in Table 2. The first IMF component ($I_1(n)$) is having higher correlation than other IMFs.

TABLE 1. Simulation parameters considered for validation of proposed work

Simulation Parameters	Considered values
Carrier Frequency	5 GHz
System bandwidth	80 MHz
Sub carrier spacing	6.83 kHz
Modulation	BPSK, QPSK, 16 QAM, 64 QAM and 256 QAM
N-point IFFT	256 point IFFT
Length of Cyclic Prefix	16 samples
Doppler Frequency	100 Hz, 500 Hz and 1000Hz

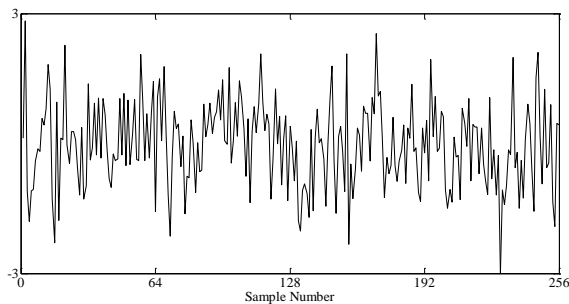

Figure 4. Received OFDM symbol of the transmitted symbol shown in Figure 4

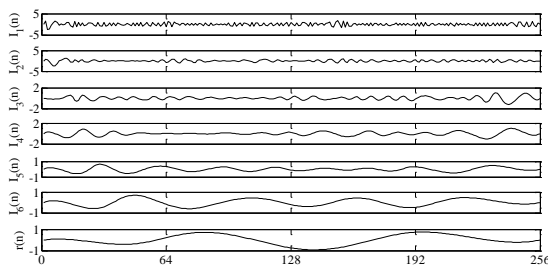

Figure 5. Decomposed IMF components of Received OFDM symbol

Kurtosis value is used when two IMF's have closer correlation value, then the IMF with lower value of kurtosis is considered for final selection. In addition to the above process, the received OFDM after being passed through AIC block, resulted in the length of CIR estimated as 36. Now, the $I_1(n)$ is decimated to the length of 36, as evaluated by AIC.

Length of IMF is 256, and the length of CIR estimated as per AIC is 36. Now the selected IMF component is resampled by a factor (9/64). The decimated impulse response is shown in Figure 6, assumed CIR for the above simulation is shown in Figure 7, and the estimated CIR after adaptive filtering is shown in Figure 8, which will be used for equalization.

TABLE 2. Calculated correlation and Kurtosis values

	Pearson Correlation	Kurtosis
$I_1(n)$	0.7760	1.9511
$I_2(n)$	0.3188	3.2426
$I_3(n)$	0.2833	4.3859
$I_4(n)$	0.1871	4.9890
$I_5(n)$	0.0586	5.7068
$I_6(n)$	0.0149	3.4342
$r(n)$	0.0119	7.8227

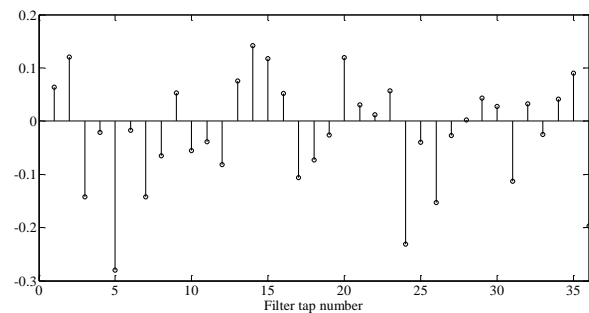

Figure 6. Initial impulse response of adaptive filter before adaptation process

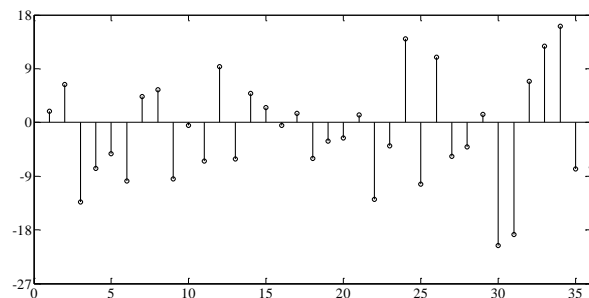

Figure 7. Assumed CIR of wireless channel

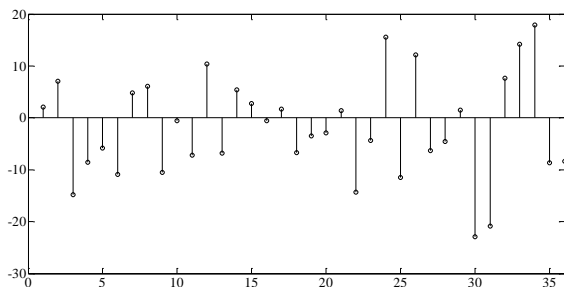

Figure 8. Final Estimated CIR of wireless channel

It can be clearly seen from the figure that the estimated CIR is closely following the trend of assumed CIR. For the sake of comparison, the convergence analysis of proposed AF is compared with conventional AF.

It can be clearly seen from Figure 9 that the proposed EMD based AF takes less number of iterations for a typical channel conditions. The improved convergence analysis is certainly due to the good initial weight vector for impulse response provided by the EMD process. Nearly only half number of iterations are required here for proposed EMD based AF as compared to normal AF.

Then, same adaptation convergence analysis is evaluated for different cases of channel using conventional adaptive filtering and is shown in Figure 10.

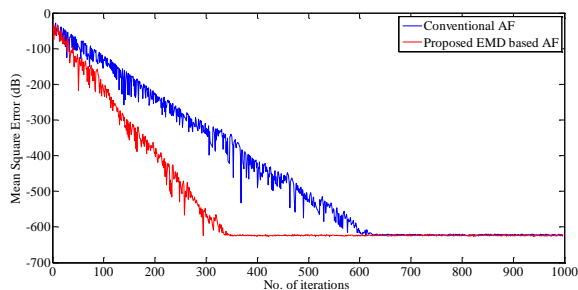

Figure 9. Convergence analysis for channel estimation: Conventional LMS AF and proposed EMD based AF for one typical case

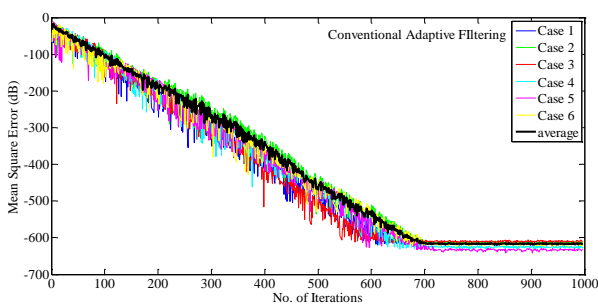

Figure 10. Convergence analysis for channel estimation: Comparison of conventional AF for 10 different cases of channel

In the same plot, average of all the cases is also shown, indicating around 700 iterations to converge. The same is repeated using proposed EMD based AF for all cases as shown in Figure 11. It can be clearly observed that the proposed EMD based AF takes almost half number of iterations as that of conventional AF to converge. For the sake of clarity, average of all cases using conventional AF and the proposed EMD based AF are shown in Figure 12. It has been noticed that the proposed EMD based AF is taking 325 ± 25 iterations, whereas the normal AF is taking 610 ± 25 number of iterations to reach MMSE point.

Most of the channel estimation methods are of the form of modified versions of least squares estimation (LSE) and minimum mean square error (MMSE). Hence, as the first step, the proposed EMD based adaptive filtering is compared with different forms of LMS algorithms in addition to well-known SVD based method for CE. In general, conventional adaptive filter is computationally simple compared to recursive least squares (RLS) algorithm. In literature, there are different variants of LMS algorithm [18, 28] with change in step size variations to improve the convergence analysis, which resulted in increased computations but better than RLS. The proposed work, resulted in improved convergence analysis as shown in Figure 13, without incorporating step size variations.

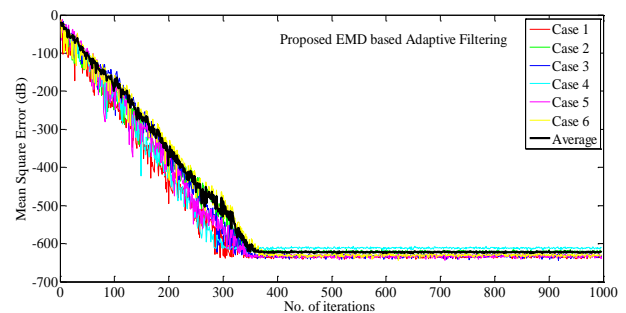

Figure 11. Convergence analysis for channel estimation: Comparison of proposed EMD based AF for 10 different cases of channel

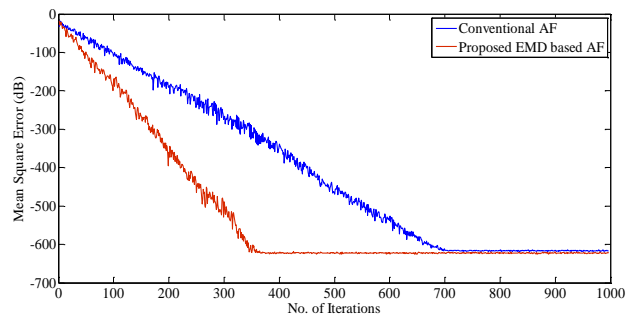

Figure 12. Convergence analysis for channel estimation: Comparison of conventional AF with proposed EMD based AF for average of 10 different cases of channel

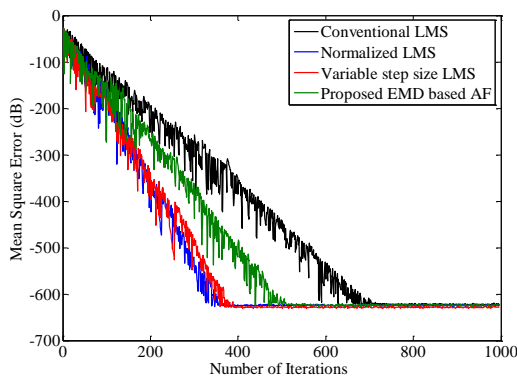

Figure 13. Convergence analysis of proposed EMD based AF with variants of LMS algorithms

The variants of LMS algorithms showed improved convergence at the cost of computations. Whereas in the proposed work improved convergence analysis is achieved with reduced computations.

This improvement is certainly due to the use of EMD generated initial weight vector for adaptive filter. The bit error rate (BER) analysis is performed for different modulation schemes BPSK, QPSK, 64-QAM and 256-QAM. The results are portrayed in Figure 14 through Figure 17. From Figure 14, under BPSK modulation it can be observed that for low values of SNR, the BER are closer but for higher values of SNR there is a clear separation. Overall there is an improvement of 3 to 5 dB in proposed EMD based AF as compared to conventional AF for BPSK constellation. Figure 15, for QPSK, the scenario is different that for low values of SNR there is a distinction, but for high values of SNR, the BER observations are close. For Figures 16 and 17 the performance improvement is unique for all values of SNR. Simulations have shown an average improvement of 3 dB in BER performance for proposed EMD based AF as compared to conventional AF. It can also be seen from these figures that the proposed EMD based AF has shown clear improvement in performance compared to the other methods for all modulation schemes as per IEEE 802.11 ac™ standards [26].

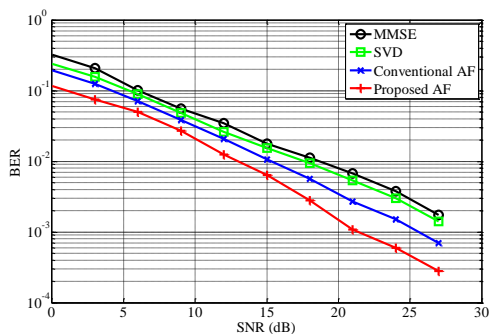

Figure 14. BER plot of OFDM transceiver using BPSK modulation Scheme

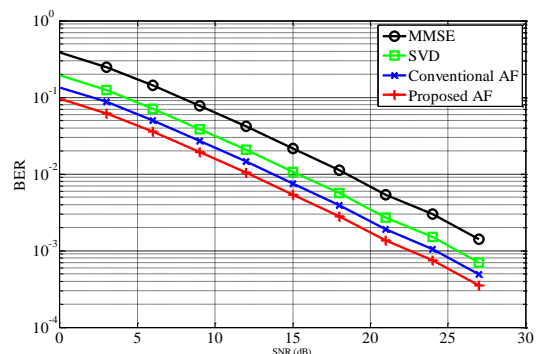

Figure 15. BER plot of OFDM transceiver using QPSK modulation Scheme

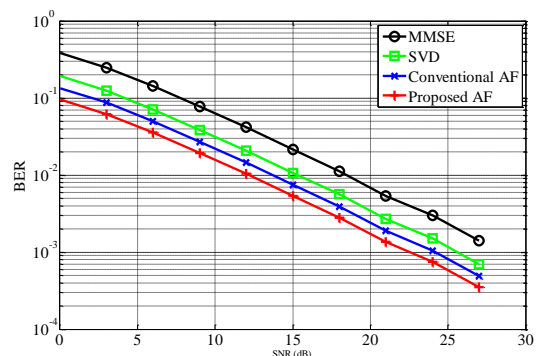

Figure 16. BER plot of OFDM transceiver using 64 QAM modulation Scheme

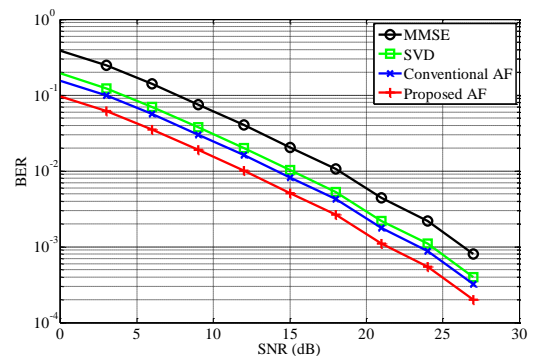

Figure 17. BER plot of OFDM transceiver using 256 QAM modulation Scheme

Similarly, the mean square error (MSE) in CE is evaluated and portrayed in Figure 18. There is a clear improvement in the values of MSE, which again can be devoted the use of EMD derived initial weight vector to the AF. The BER and MSE analysis establishes the efficacy of the proposed EMD based AF method.

In addition, to further evaluate performance of the proposed EMD based AF method, different channels such as selective fading, flat fading, slow and fast fading channel are considered. SNR improvement achievable in different methods BPSK, QPSK, 64 QAM

and 256 QAM at a BER of 10^{-2} for the proposed method compared to conventional AF method are depicted in Table 3.

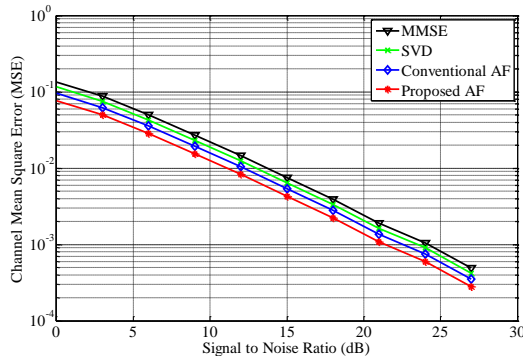

Figure 18. Channel MSE Comparison

TABLE 3. SNR improvement values of different methods at a BER of 10^{-2} for the proposed method as compared to Conventional AF method

Modulation/Fading	Flat Fading		Frequency Selective Fading	Slow fading	Fast fading
	Rayleigh fading	Rician fading			
BPSK	3 dB	2dB	2 dB	3 dB	2 dB
QPSK	5 dB	4 dB	4 dB	6 dB	5 dB
64 QAM	7 dB	5 dB	6 dB	4 dB	3 dB
256 QAM	4 dB	3 dB	2 dB	4 dB	3 dB

5. CONCLUSION

The estimation of channel impulse response (CIR) under multipath fading wireless OFDM transceiver is essential requirement for error free reception. In this direction, a novel empirical mode decomposition (EMD) based adaptive filtering (AF) was presented in this paper for OFDM CE under Rayleigh and Rician fading channels. In general, conventional AF uses random initial weight vector. The novelty of the proposed method is that it uses a decimated selective intrinsic mode function (IMF) of received OFDM symbol as the initial weight vector. This made the process of adaptation and consequently the estimation of CIR simple. Improved convergence analysis was achieved with reduced computations. The Bit error rate (BER) and mean square error (MSE) simulation studies established the efficacy of proposed method; and comparative studies under different modulation schemes and fading conditions revealed improved performance. The proposed method has shown an average improvement of 3-5 dB over conventional AF method and 6-8 dB over SVD based method.

6. REFERENCES

1. Cimini, L., "Analysis and simulation of a digital mobile channel using orthogonal frequency division multiplexing", *IEEE Transactions on Communications*, Vol. 33, No. 7, (1985), 665-675.
2. Casas, E.F. and Leung, C., "Ofdm for data communication over mobile radio fm channels. Ii. Performance improvement", *IEEE Transactions on Communications*, Vol. 40, No. 4, (1992), 680-683.
3. Van De Beek, J.-J., Edfors, O., Sandell, M., Wilson, S.K. and Borjesson, P.O., "On channel estimation in ofdm systems", in Vehicular Technology Conference, IEEE 45th, Vol. 2, (1995), 815-819.
4. Kavehrad, M., "Quadrature amplitude modulated digital radio transmission modeling and simulation", *International Journal of Engineering*, Vol. 5, No. 1&233, (1992) 33-38.
5. Ahmed, F., Ying, F. and Li, R., "A multiband multiple-input multiple-output antenna system for long term evolution and wireless local area networks handsets", *International Journal of Engineering-Transactions B: Applications*, Vol. 29, No. 8, (2016), 1087-1095.
6. Edfors, O., Sandell, M., Van de Beek, J.-J., Wilson, S.K. and Borjesson, P.O., "Ofdm channel estimation by singular value decomposition", *IEEE Transactions on Communications*, Vol. 46, No. 7, (1998), 931-939.
7. Coleri, S., Ergen, M., Puri, A. and Bahai, A., "Channel estimation techniques based on pilot arrangement in ofdm systems", *IEEE Transactions on Broadcasting*, Vol. 48, No. 3, (2002), 223-229.
8. Chang, M.-X. and Su, Y.T., "Model-based channel estimation for ofdm signals in rayleigh fading", *IEEE Transactions on Communications*, Vol. 50, No. 4, (2002), 540-544.
9. Zhang, W., Xia, X.-G. and Ching, P.-C., "Optimal training and pilot pattern design for ofdm systems in rayleigh fading", *IEEE Transactions on Broadcasting*, Vol. 52, No. 4, (2006), 505-514.
10. Edfors, O., Sandell, M., Van De Beek, J.-J., Wilson, S.K. and Börjesson, P.O., "Analysis of dft-based channel estimators for ofdm", *Wireless Personal Communications*, Vol. 12, No. 1, (2000), 55-70.
11. Lyman, R.J. and Edmonson, W.W., "Decision-directed tracking of fading channels using linear prediction of the fading envelope", in Signals, Systems, and Computers, Conference Record of the Thirty-Third Asilomar Conference on, IEEE. Vol. 2, (1999), 1154-1158.
12. Hoehner, P. and Tufvesson, F., "Channel estimation with superimposed pilot sequence", in Global Telecommunications Conference. GLOBECOM'99, IEEE. Vol. 4, (1999), 2162-2166.
13. Al-Naffouri, T.Y., "An em-based forward-backward kalman filter for the estimation of time-variant channels in ofdm", *IEEE Transactions on Signal Processing*, Vol. 55, No. 7, (2007), 3924-3930.
14. Tauböck, G., Eiwien, D., Hlawatsch, F. and Rauhut, H., "Compressive estimation of doubly selective channels: Exploiting channel sparsity to improve spectral efficiency in multicarrier transmissions", *IEEE Journal of Selected Topics in Signal Processing*, to Appear, (2009), 365-372.
15. Liu, Y., Tan, Z., Hu, H., Cimini, L.J. and Li, G.Y., "Channel estimation for ofdm", *IEEE Communications Surveys & Tutorials*, Vol. 16, No. 4, (2014), 1891-1908.
16. de Temino, L.A.M.R., i Manchon, C.N., Rom, C., Sorensen, T.B. and Mogensen, P., "Iterative channel estimation with robust wiener filtering in lte downlink", in Vehicular Technology Conference, VTC 2008-Fall. IEEE 68th, IEEE. (2008), 1-5.

17. Udawat, A., Sharma, P. and Katiyal, S., "Optimization capabilities of lms and smi algorithm for smart antenna systems", (2013).
18. Liang, Y., Luo, H., Yan, C. and Huang, J., "Channel estimation using adaptive filters in mimo-ofdm systems", in Wireless Communications, Networking and Mobile Computing. WiCOM International Conference on, IEEE. (2006), 1-4.
19. Zhang, W., Gao, F. and Yin, Q., "Blind channel estimation for mimo-ofdm systems with low order signal constellation", *IEEE Communications Letters*, Vol. 19, No. 3, (2015), 499-502.
20. Beygi, S. and Mitra, U., "Multi-scale multi-lag channel estimation using low rank approximation for ofdm", *IEEE Transactions on Signal Processing*, Vol. 63, No. 18, (2015), 4744-4755.
21. Bakhshi, H., Ghassemian, H. and Kahrizi, M., "Bit error performance for asynchronous ds cdma systems over multipath rayleigh fading channels (research note)", *International Journal of Engineering-Transactions A: Basics*, Vol. 15, No. 2, (2002), 135-143.
22. Huang, N.E., Shen, Z., Long, S.R., Wu, M.C., Shih, H.H., Zheng, Q., Yen, N.-C., Tung, C.C. and Liu, H.H., "The empirical mode decomposition and the hilbert spectrum for nonlinear and non-stationary time series analysis", in Proceedings of the Royal Society of London A: mathematical, physical and engineering sciences, The Royal Society. Vol. 454, (1998), 903-995.
23. Kelly, V., "New ieee 802.11 ac™ specification driven by evolving market need for higher, multi-user throughput in wireless lans", *IEEE. Retrieved*, (2014), 1-11.
24. Cho, Y.S., Kim, J., Yang, W.Y. and Kang, C.G., "Mimo-ofdm wireless communications with MATLAB", John Wiley & Sons, ISBN: 978-0-470-82562-4, (2010).
25. Simon, H., "Adaptive filter theory", *Prentice Hall*, Vol. 2, (2002), 478-481.
26. Akaike, H., "A new look at the statistical model identification", *IEEE Transactions on Automatic Control*, Vol. 19, No. 6, (1974), 716-723.
27. Tomasoni, A., Gatti, D., Bellini, S., Ferrari, M. and Siti, M., "Efficient ofdm channel estimation via an information criterion", *IEEE Transactions on Wireless Communications*, Vol. 12, No. 3, (2013), 1352-1362.
28. Li, M. and Xi, X., "A new variable step-size nlms adaptive filtering algorithm", in Information Technology and Applications (ITA), International Conf, (2013), 236-239.

Empirical Mode Decomposition based Adaptive Filtering for Orthogonal Frequency Division Multiplexing Channel Estimation

E. Hari Krishna^a, K. Sivani^b, K. Ashoka Reddy^c

^a Electronics and Communication Engineering Department, University College of Engineering, Kakatiya University, Kothagudem, Telangana, India

^b Electronics and Instrumentation Engineering Department, Kakatiya Institute of Technology & Science, Warangal, Telangana, India

^c Electronics and Communication Engineering Department, Kakatiya Institute of Technology & Science, Warangal, Telangana, India

PAPER INFO

چکیده

Paper history:

Received 07 June 2017

Received in revised form 15 July 2017

Accepted 12 August 2017

Keywords:

Orthogonal Frequency Division Multiplexing
Multi Carrier Channel Estimation
Adaptive Filtering
Empirical Mode Decomposition
Multipath Fading Channel

این مقاله یک فیلتر انطباق مبتنی بر تجزیه حالت تجربی (EMD) را برای تخمین کانال در سیستم OFDM ارائه می دهد. در این روش، طول پاسخ ضربان کانال (CIR) ابتدا با استفاده از معیار اطلاعات Akaike (AIC) تقریب زده می شود. سپس CIR با استفاده از فیلتر انطباق با EMD تجزیه شده از IMF از نماد OFDM دریافت شده تخمین زده می شود. برای ارزیابی مولفه های IMF از میان IMF های موجود استفاده از اقدامات همبستگی و kurtosis استفاده می شود. AF متعارف از بردار وزن اولیه تصادفی استفاده می کند. نوآوری روش پیشنهادی این است که از نسخه خراب شده یکی از IMF های تجزیه شده از نماد OFDM دریافت شده به عنوان بردار وزن اولیه استفاده می کند. این باعث می شود روش AF مبتنی بر EMD با حداقل تعداد خطای مربع (MMSE) در تعداد کمی از تکرارها منجر به صرفه جویی در حدود ۵۰٪ زمان محاسبه شود. مطالعات شبیه سازی با استفاده از محاسبات خطای بیت (BER) و میانگین مربعات خطا (MSE)، اثربخشی روش پیشنهاد شده را تأیید کرد و مطالعات تطبیقی تحت برنامه های مختلف مدولاسیون و شرایط محو شوندگی عملکرد را بهبود بخشید.

doi: 10.5829/ije.2017.30.10a.13