

(MF-285)

*

(/ / : / / :)

()

(GPS)

()

/ ()

(McBratney et al., 2005)

()

(Yule et al., 1999)

(Tompkins & Wilhelm, 1982)

(Khalilian et al., 1989)

(Griffith et al., 1988; Thomson & Shinnars, 1987)

(Khalilian et al., 1989)

(Alimardani et al., 1989)

(Khalilian et al., 1989; Lotfi et al., 2007; RNAM, 1983).

(GPS)⁴

(Morgan & Ess, 1997)

(Raheman & Jha, 1997)

(ASAE, S296.2, DEC03)

π

() Grevis-James

(Yahya, 2003; Yule et al., 1999)

(Raheman & Jha, 1997)

7. Radar speed sensor
 8. Ultrasonic speed sensor
 9. Global Positioning System (GPS)
 10. Encoder shaft
 11. Proximity switch

1.Sensors
 2.Data acquisition systems
 3.Spatial variability
 4. Parameter
 5. Draft
 6. Tractive efficiency

(Morgan

() Yule et al. . & Ess, 1997)

() Masoumi & Logavi

() Hemmat & Asadi Khashoei .

(DGPS)

(Alciatore &. Histan,

.2003)

(Alciatore &. Histan,

.2003)

(:

()'

(MF-)

() Alimardani et al., .

و (" در

(Lotfi et al., 2007)

(

()

.(Yahya, 2003)

(MF-)

Grevis- .

(:

() James

(

(

)

(McLaughlin,

.1993; Tompkins & Wilhelm, 1982)

(

(GPS)

)

GPS

4. Differential GPS
5. Proximity sensor

1. Compression ignition (CI)
2. Micro oval
3. Hall effect

$$= \times \pi \times / = / \text{ m}$$

$$\Rightarrow \frac{4.68\text{m/Rev}}{400\text{Pulse/Rev}} = 0.0117\text{m/Pulse}$$

(Lotfi et al., 2007)

1. Flexible coupling
2. Kingpin

پایه نگهدارنده

شفت انگدر

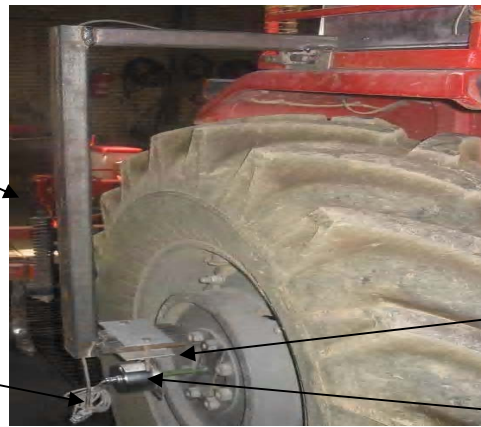

فلنج مستطیلی شکل

اتصال انعطاف پذیر

پایه نگهدارنده

شفت انگدر

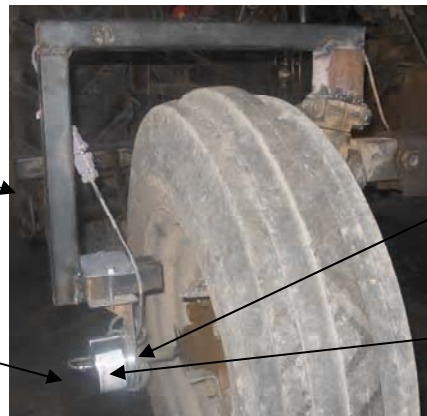

فلنج مستطیلی شکل

اتصال انعطاف پذیر

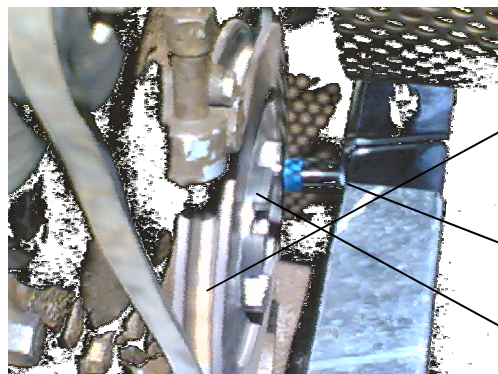

حلقه زائده دار

پایه حسگر

حسگر القایی

(Garmin

.Etrex Owner's manual, 2003)

()

()

RSMC⁴

RSMC FCMC

FCMC⁵

(MF-)

SGMC⁶

GPS

GPSC⁷

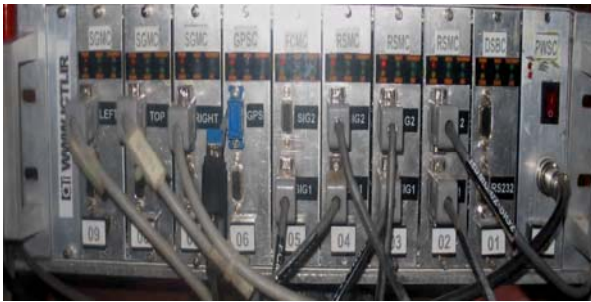
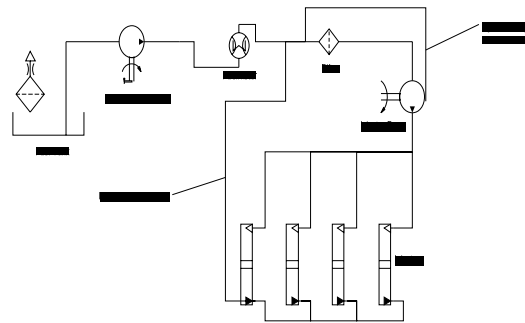

()

TPHD

C⁺⁺

GPS δ

3. Distributed network
4. Rotary Speed Meter Card
5. Fuel Consumption Meter Card
6. Strain Gauge Meter Card
7. Global Positioning System Card

1. Roto
2. Garmin

(

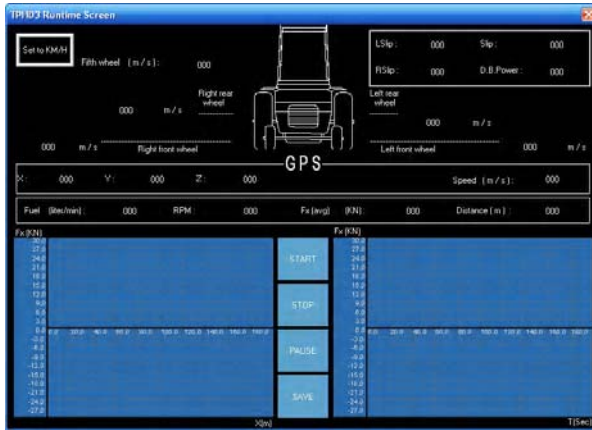

TPHD

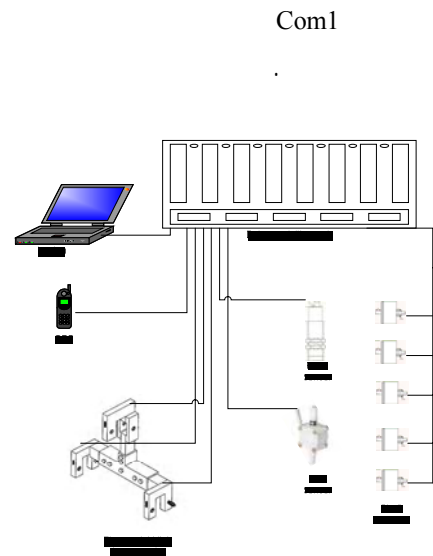

TPHD

δ Test RUN

Runtime

$$\delta = \frac{\text{Power}}{\text{Force}} \times \text{Time} \quad (*)$$

$$(\text{kW}) = (\text{kN}) \times \left(\frac{\text{m}}{\text{s}}\right) \quad ($$

TPHD

Runtime ()

3. Reflector
4. Pulley

1. Slip
2. Drawbar power

(U650)

(Hemmat et al., 2000; RNAM,

1983)

()

در "

(:

(Lotfi et al., 2007)

((MF-)

) (U-650)

/ ("

(
U-650

TPHD Owen et
Andrade-Sánchez et al., (2003)

.al., (1990)

.(Alciatore & Histan, 2003)

(FFT)

×

$$X(f) = \int_{-\infty}^{+\infty} x(t) \cdot e^{-2j\pi ft} dt$$

x(t)

X(f)

f t

x(t)

$$j = \sqrt{-1}$$

(d₁₇) (d₁₄)

(m₃) / (m₂) / (m₁) /

MatLab

Khalilian et al. (1989)

Excel

r

(

)

(

()

)

GPS

"

TPHD

(

)

()

f

GPS

GPS

/

- 2. Standard error
- 3. Stop - watch
- 4. Skid

1. Post processing

()

GPS

/

/

/

/

/

/

/

/

/

/

/

/

/

/

/

/

/

/

/

/

/

/

/

/

/

/

/

/

/

/

/

/

/

/

/

/

/

/

/

/

/

/

/

/

/

+ /

+ /

/

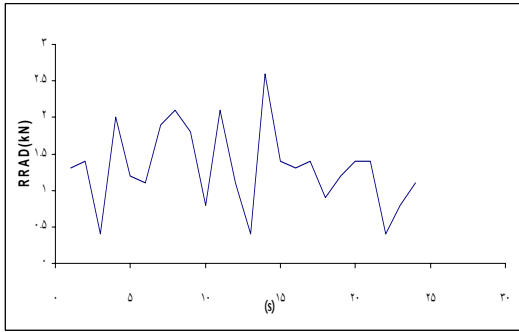

()
: RRAD)

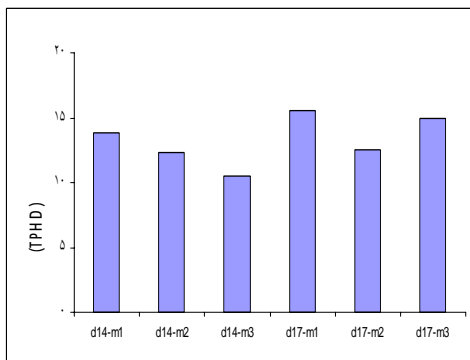

m d.

(Draft_{AD})

(Draft_{TPHD})

(/)

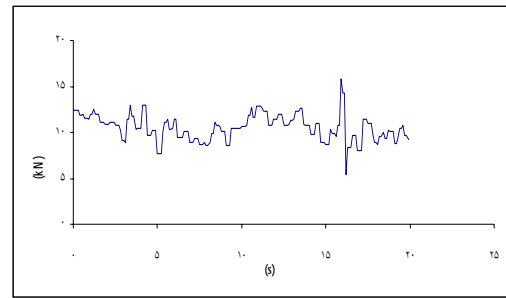

() ()

(DRRAD)

(RRAD)

DRRAD

RRAD

()

Draft_{AD}

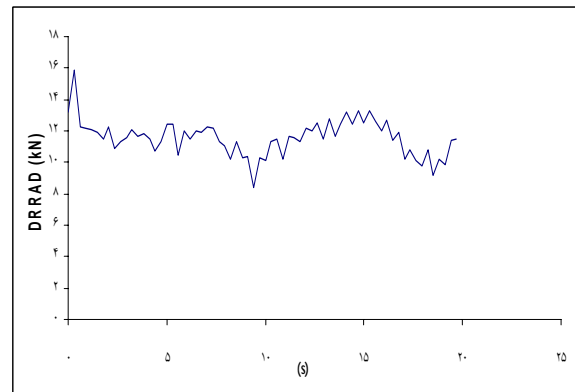

: DRRAD)

(Alciatore & Histan, 2003)

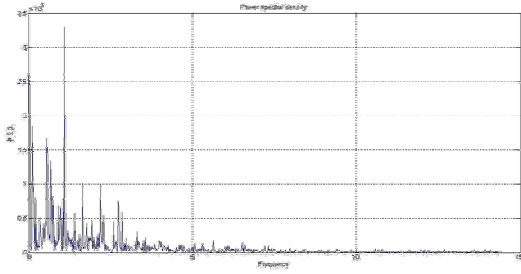

TPHD

(GPS)

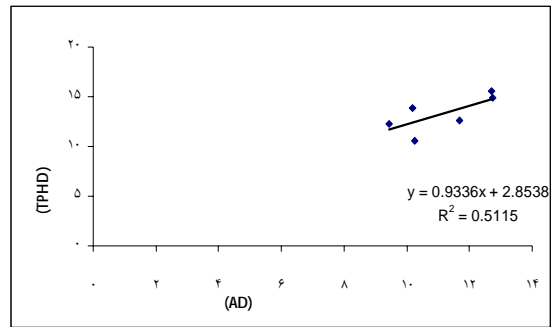

(TPHD)

(AD)

()

()

REFERENCES

- Alciatore, D. G. & Histan, M. B. (2003). *Introduction to mechatronics and measurement systems* (2nd ed) New York: McGraw-Hill.
- Alimardani, R., Colvin, T. S. & Marley, S. J. (1989). An instrumentation system for monitoring tractor field performance. *Land Water Use* Pp: 3035-3043.
- Andrade-Sánchez, P., Upadhyaya, S. K. & Sakai, K. (2003). Variability in draft data observed during tillage. *ASAE Paper No.* 031121. St. Joseph, Mich.: ASAE.
- ASAE S296.2 DEC03. (2003). General terminology for traction of agricultural traction and transport devices and vehicles. *ASAE Standards*. 2950 Niles Road, St Joseph, MI.
- Clark, R. L. & Adsit, A. H. (1985). Microcomputer-based instrumentation system to measure tractor field performance. *Transactions of the ASAE*, 28: 393-396.
- Grevis-James, I. W. & Bloome, P. D. (1982). A tractor power monitor. *Transactions of the ASAE*, 25: 595-597.
- Grevis-James, I. W., DeVoe, D. R., Bloome, P. D., Batchelder, D. G. & Lambert, B. W. (1983). Microcomputer-based data acquisition for tractor. *Transactions of the ASAE*, 26: 692-695.
- Griffith, D. R., Zwilling, E. L., Wigger, W. D., Hummel, J. W. & Goering, C. E. (1988). Data collection system for tillage performance. *ASAE Paper No.* 88-1560. St. Joseph, Michigan.
- Hemmat, A. & Asadi Khashoei, A. (1995). Fuel requirement and machine capacity for tillage and planting operations on a clay loam soil in Isfahan. *Iran Agricultural Research*, 14:175-201. (In Farsi)
- Hemmat, A., Sadeghnezhad, H. R. & Alimardani, R. (2000). Draft of a vibrating-share subsoiler with and without vibrating mode and its effects on soil physical properties. *Iranian Journal of Agricultural Sciences*, 31(1):127-144. (In Farsi)
- Khalilian, A., Hale, S., Hood, C., Garner, T. & Dodd, R. (1989). Comparison of four ground speed measurement techniques. *ASAE Paper No.* 89-1040. St. Joseph, Michigan.
- Lotfi, D., Hemmat, A. & Akhanan Sarraf, M. R. (2007). Development and evaluation of a three-point hitch dynamometer and a fifth wheel for mounted implement draft and tractor speed measurements. *Journal of Science & Technology, of Agriculture & Natural Resources* 11(1): 147-163. (In Farsi)
- Masoumi, A.A. & Logavi, M. (1994). Evaluation and comparison of traction of two common tractors in Iran. *Iran Agricultural Research*, 13(2): 77-95
- McBratney, A., Whelan, B., Ancev T. & Bouma, J. (2005). Future directions of precision agriculture. *Precision Agriculture*, 6: 7-23.
- McLaughlin, N. B., Heslop, L. C., Bukley, D. J., Amour, G. R. St., Compton, B. A., Jones, A. M. & Van Bodegom, P. (1993). A general purpose tractor instrumentation and data logging system. *ASAE paper No.* 0001-2351. St. Joseph, Michigan.
- Morgan, M., & Ess, D. (1997). *The precision – farming guide for agriculturists*. John Deere Publ. Translated by M. Loghvi, 2004.
- Murphy, M. C. (1993). *Report of farming in the Eastern Counties of England 1991-92*. Agricultural Economics Unit, Department of Land Economy, University of Cambridge, UK
- Owen, G. T., McRae, K. B., McRae, S. M. & Misener, G. C. (1990). Spectral analysis of subsoiling forces with a rigid tillage tool. *Canadian Journal of Agricultural Engineering*, 32: 57-62.
- Owner's manual, (2003). Garmin Etrex. Retrieved January 12, 2003, from www.garmin.com
- Raheman, H. & Jha, S. K (2007). Wheel slip measurement in 2WD tractor. *Journal of Terramechanics* 44(1): 89-94.
- Regional Network for Agricultural Machinery. (1983). *RNAM test codes and procedures of farm machinery*. Technical Series No. 12. Bangkok Thailand 291 p.
- Smith, L. A. (1993). Energy requirement for selected crop production implements. *Soil & Tillage Research*, 25: 281-299.
- Thomson, N. P. & Shinnors, K. J. (1987). A portable instrumentation system for measuring tillage draft and speed. *ASAE Paper No.* 87-1521. St. Joseph, Michigan.
- Tompkins, F. D. & Wilhelm, L. R. (1982). Microcomputer-based tractor data acquisition system. *Transactions of the ASAE*, 25: 1540-1543.
- Yahya, A. (2003). A tractor data acquisition system for field power and energy demand mapping. Retrieved January 15, 2004, from www.eng.uom.edu.my/kbp/research/az_aq.htm
- Yasin, M., Grisso, R. D. & Lackas, G. M. (1992). Non-contact system for measuring system for tillage depth. *Computers and Electronics in Agriculture*, 7: 133-147.
- Yule, I. J., Kohnen, G. & Nowak, M., (1999). A tractor performance monitor with DGPS capability. *Computers and Electronics in Agriculture*, 23: 155-174.

