

( ) , ( )

\*

( // : // : )

) rms  
rms  
*a<sub>hv</sub>*

rms :

Paddan & Griffine (Salokhe et al., 1995)

( )

ISO

Paddan & )

Temmerman et al.

(Griffin, 2002

( )

(Tewari et al., 2004 )

1. Van  
2. Frequency-Weighted Acceleration

( )

Salokhe et al.

( ) Marsili et al.

( ) Hansson .

Salokhe .

( ) et al.

(MITSUBISHI, 7.7hp-2400rpm)

( )

( ) Goglia et al.

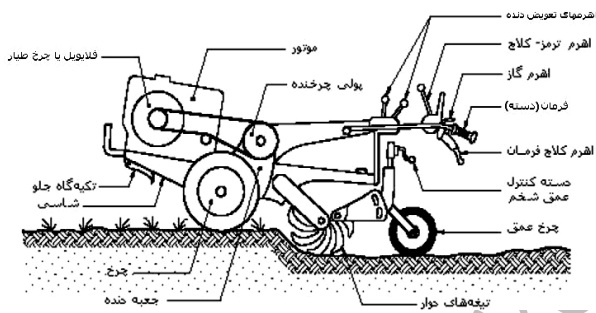

( ) Kumar et al.

ISO

( ) Ragni et al. .

( )

)

(

(DIGITAL PHOTO/CONTACT TACHOMETER, Lutron DT-2236, 0.5-100,000 RPM, Accuracy:  $\pm(0.05\%+1\text{digit})$ , Made in Taiwan)

٤

TV 300

( )

(TSV-01)

.(Rossegger & Rossegger, 1960)

kHz Hz

PC

( ) Salokhe et al.

rms

rms

( )

$a_{hv}$

rms  
(CRD)

:(ISO 5349-1, 2001)

$$a_{hv} = \sqrt{a_{hwx}^2 + a_{hwy}^2 + a_{hwz}^2} \quad ( )$$

ISO 5349-2 ISO 5349-1

(Rao,

rms

(FFT)

.1995)

( )

(

( )

( )

(

(Inman, 1989)

:(Barber, 1992)

$$a_{rms} = \sqrt{1/T \int_0^T a^2 dt} \quad (1)$$

$a$

$T$

rms

$a_{rms}$

$t$

( )

rms

$a_{hwz} \ a_{hwy} \ a_{hwx}$

$z \ y \ x$

(ISO 5349-1, 2001; ISO 5349-2, 2001)

- 6. Vibration Total Value
- 7. Handle Grip

- 1. MSTATC
- 2. Excel 2003
- 3. SPSS 13
- 4. Frequency Analysis
- 5. MATLAB 7

( )

Hz

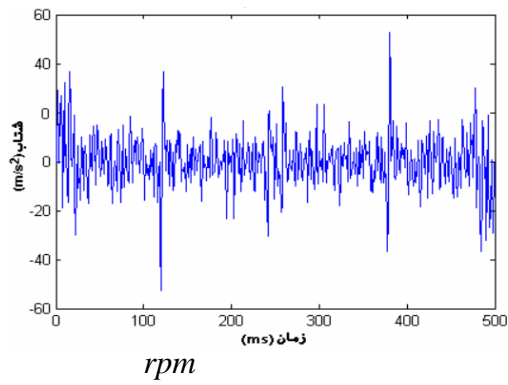

( )

( )

( )

)

(

( )

rpm

Hz

/ Hz

/ Hz

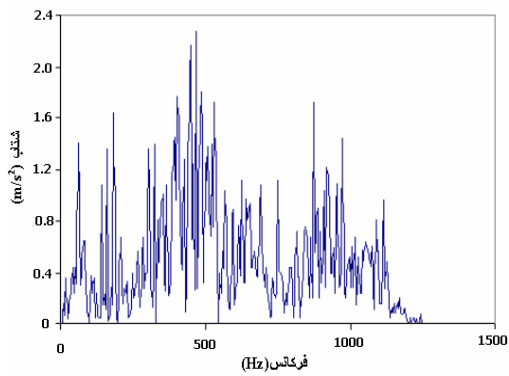

rpm

فرکانس (Hz)

( )

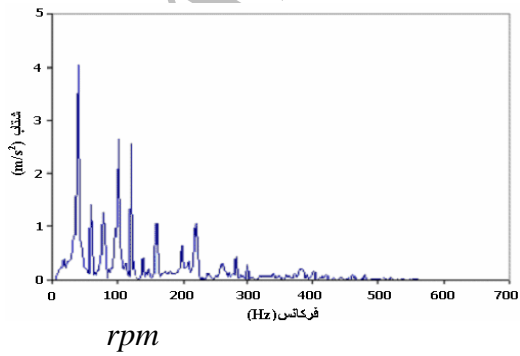
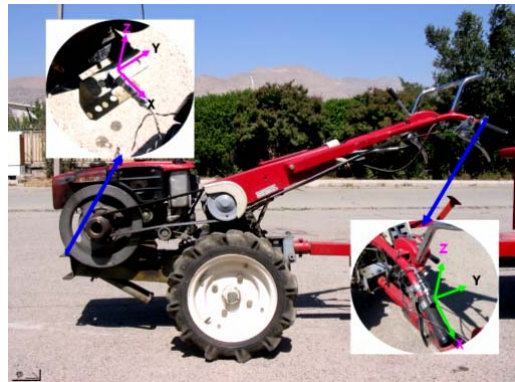

rpm

فرکانس (Hz)

( )

( )

Hz

( )

(FFT)

( )

... :  
 ( ) ( )  
 Hz / Hz

( )

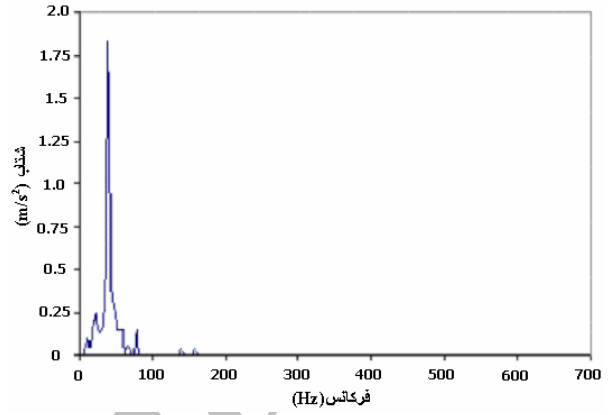

( ) Salokhe et al.  
 rpm  
 Hz  
 rpm / sec ( ) = Hz

( ) rms rpm ( )

(CRD)  
 rms  
 %

( )

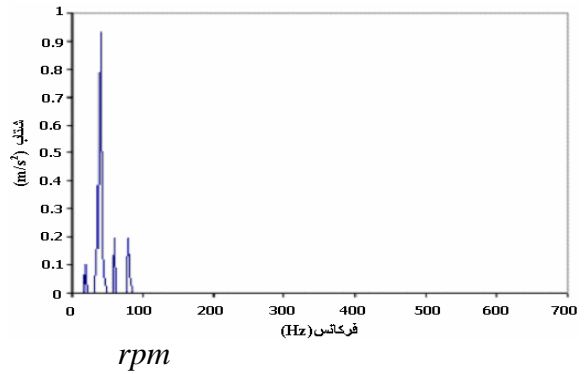

%  
 ( × )

(% )

---

/ **	/ **	/ **	/ **	/ **
/ **	/ **	/ **	/ **	/ **
/ **	/ **	/ **	/ **	/ **
/	/	/	/	/

---

% \*\*

( )  
 rms rms  
 rpm rpm rpm

( )

( )

rms

rms

(% )

( $m/s^2$ )

(rpm)

/ a	/ b	/ b	/ c	/ d	/ e
/ a	/ b	/ c	/ d	/ e	/ f
/ a	/ c	/ b	/ d	/ d	/ e
/ b	/ a	/ b	/ c	/ d	/ e
/ a	/ b	/ b	/ b	/ b	/ c
/ d	/ a	/ b	/ a	/ ab	/ dc
/ a	/ b	/ c	/ d	/ e	/ f
/ a	/ b	/ c	/ d	/ e	/ f
/ d	/ b	/ a	/ c	/ e	/ f
/ bc	/ a	/ cb	/ ba	/ dc	/ d
/ c	/ a	/ b	/ d	/ e	/ f
/ a	/ ba	/ cb	/ db	/ ed	/ e
/ ed	/ cb	/ dc	/ a	/ ba	/ e
/ ab	/ a	/ ab	/ a	/ ab	/ b
/ a	/ a	/ a	/ a	/ b	/ c

)

(

( )

rms

(Salokhe et al., 1995; Tewari et al., 2004)

( )

(Paddan & Griffin, 2002)

$a_{hv}$

$a_{hv}$

$a_{hv}$

$a_{hv}$

$a_{hv}$

( )

Z Y X

$a_{hv}$

| | | rpm  
| | | | | m/s<sup>2</sup> |  
| | | | | m/s<sup>2</sup>

$a_{hv}$

$a_{hv}$

| m/s<sup>2</sup> | | | | |

Archive of SID

( )

$a_{hv}$   $a_{hv}$   
 $a_{hv}$  ( )

$a_{hv}$

$a_{hv}$   
 $a_{hv} (m/s^2)$

rms

:(Stikeleather, 1991)

$T_r = \frac{a_i (\text{بارو و قفسه سینه})}{a_i (\text{مست})}$  (۳)

i

a

$T_r$

$a_{hv} (m/s^2)$	
	**
	**
	**
	x
%	
$a_{hv}$	( )
**	

$T_r$  ( ) ( )

$a_{hv}$

( )

rpm

rpm

$a_{hv}$

( )

/ % / / ( ) . % / / /

(%)		$a_{hv} (m/s^2)$			(rpm)
$(a_{hv})$	$(a_{hv})$	$(a_{hv})$	$(a_{hv})$	$(a_{hv})$	
/ d	/ c	/ b	/ a	/ b	
/ e	/ d	/ c	/ a	/ b	
/ e	/ d	/ c	/ a	/ b	
/ d	/ c	/ b	/ a	/ b	
/ d	/ c	/ b	/ a	/ b	
/ d	/ c	/ b	/ a	/ b	

$T_r$

طول	جانبی	عمودی	دور (rpm)
۳۶/۹۶	۱۳/۴۷	۳۳/۲۹	۱۳۰۰
۳۷/۸۸	۱۶/۶	۳۲/۵۵	۱۶۰۰
۳۳/۲۰	۱۶/۱۷	۳۱/۶۲	۱۸۰۰
۳۱/۲۷	۲۱/۱۴	۱۹/۸۸	۲۰۰۰
۴۴/۲۹	۱۵/۸۵	۲۳/۰۵	۲۲۰۰
۵۳/۸۵	۱۶/۰۹	۱۵/۸	۲۴۰۰
۳۹/۵۷	۱۶/۵۵	۲۶/۰۳	میانگین

(Salokhe et al., 1995)

طول	جانبی	عمودی	دور (rpm)
۱۰/۲۸	۴/۱۰	۱۰/۰۵	۱۳۰۰
۱۰/۷۷	۴/۴۲	۱۱/۱۶	۱۶۰۰
۱۰/۲۵	۴/۰۹	۹/۶۸	۱۸۰۰
۹/۱۹	۲/۲۳	۵/۱۵	۲۰۰۰
۱۰/۲۷	۲/۵۵	۴/۸۸	۲۲۰۰
۱۳/۰	۱/۹۸	۳/۸۰	۲۴۰۰
۱۰/۶۳	۳/۲۳	۷/۴۵	میانگین

( )

( ) Salokhe et al.

( )

rpm

( )

%

Marsili et al.,)

(2002)

%



rms

(rms)

(Hansson, 2002)

Salokhe et al.

(Barber, 1992)

Paddan & Griffin, )

(2002

## REFERENCES

- Anonymous, (2003). Philippine agricultural engineering standard pages 110: 2001. *Agricultural Machinery – Walking-type Agricultural Tractor – Specifications*. Part 2: Rotary Tilling-type.
- Barber, A. (1992). *Handbook of Noise and Vibration Control*. Elsevier Science Publishers LTD .6<sup>th</sup> Edition. 730pp.
- Goglia, V., Gospodari, Z., Kosutic, S. & Filipovi, D. (2003). Hand-transmitted vibration from the steering wheel to drivers of a small four-wheel drive tractor. *Applied Ergonomics*, 34,45–49.
- Hansson, P.A. (2002). Working space requirement for an agricultural tractor axle suspension. *Biosystems Engineering*, 81(1), 57-71.
- Inman, D.G. (1989). *Vibration with Control, Measurement, and Stability*. Prentice-Hall International Inc, Printed in the United States of America, P.27-182, 352pp.
- ISO 5349-1, (2001). *Mechanical Vibration—Measurement and Evaluation of Human Exposure to Hand-Transmitted Vibration—Part 1: General Requirements*, ISO, Geneva.
- ISO 5349-2, (2001). *Mechanical Vibration—Measurement and Evaluation of Human Exposure to Hand-Transmitted Vibration—Part 2: Practical Guidance for Measurement at the Workplace*.
- Kumar, A., Mahajan, P., Mohan, D. & Varghese, M. (2001). Tractor vibration severity and driver health: a study from rural India. *J. Agric. Engng Res.* 80 (4), 313-328.
- Marsili, A., Ragni, L., Santoro, G., Servadio, P. & Vassalini, G. (2002). Innovative systems to reduce vibrations on agricultural tractors: comparative analysis of acceleration transmitted through the driving seat. *Biosystems Engineering*, 81 (1), 35-47.
- Paddan, G.S, & Griffin, M.J. (2002). Evaluation of whole-body vibration in vehicles. *Journal of Sound and Vibration*, 253(1), 195-213.
- Ragni, L., Assalini, G.V., Xu, F. & Zhang, L.B. (1999). Vibration and noise of small implements for soil tillage. *J. Agric. Engng Res*, 74, 403-409.
- Rao, S.S. (1995). *Mechanical Vibration*. Third Edition. Addison Publishing Company. 1100pp.
- Rossegger, R. & Rossegger, S. (1960). Health effects of tractor driving. *J. Agric, Engng, Res*, 5, 241-275.
- Salokhe, V. M., Majumder, B. & Islam, M. S. (1995). Vibration characteristics of a power tiller. *Journal of Terramechanics*, 32, 81-197.
- Stikeleather, L.F. (1991). Seat vibration and ride comfort. In *Human Factors: A series of Quality Instructional Material*. ASAE.
- Temmerman, D. J., Deprez, K., Anthonis, J. & Ramon, H. (2004). Conceptual cab suspension system for a self-propelled agricultural machine, Part 1: Development of a linear mathematical model. *Biosystems Engineering*, 89, 409–416.
- Tewari, V. K., Dewangan, K. N. & Karmakar, S. (2004). Operator's fatigue in field operation of hand tractors. *Biosystems Engineering*, 89,1–11.