

\*

(CRS)

( )

( ) Lee et al. (ASTM - D4186, 2002)

Almeida et .

(CRS)

( ) Hamilton and Crawford

( ) al.

Lee et al. ( )

CRS

(Dubak, 2003)

(Younes and Chung, 2005)

% / % /

Esmith and Wahls .

( )

Hamilton and Crawford, )

%

CRS

(1959

( ) Wissa et al.

Wissa et al.

( ) Esmith and Wahls

( ) Sallfors .

%

( )

Gromen et %

CRS

%

( ) al.

( ) Sheahan and Watters .

%

(m<sub>v</sub>)

( )

( ) Sheahan and Watters

(Load Cell)

(LVDT)

CRS

( )	PL (%)		LL (%)		Gs	
CL	/	/	/	/	/	A
CL	/	/	/	/	/	B
CH	/	/	( )	( )	/	C
CH	/	/	( )	( )	/	D

CRS

(kPa)		%	%/min	
7/24	1/78	74/2	/	1A
	1/80	70/2	/	2A
	1/76	68/1	/	3A
	1/77	68/1	/	4A
9/4	1/83	67/4	/	1B
132/6	1/81	66/2	/	2B
203	1/87	70/1	/	3B
526	1/80	68/4	/	4B
2	2/4	89	/	1C
14	2/4	88	/	2C
22	2/41	89	/	3C
50/6	2/5	84	/	4C
1/7	0/9	33	/	1D
9/6	0/90	30	/	2D
22	0/93	32/96	/	3D
30/5	0/92	32/96	/	4D

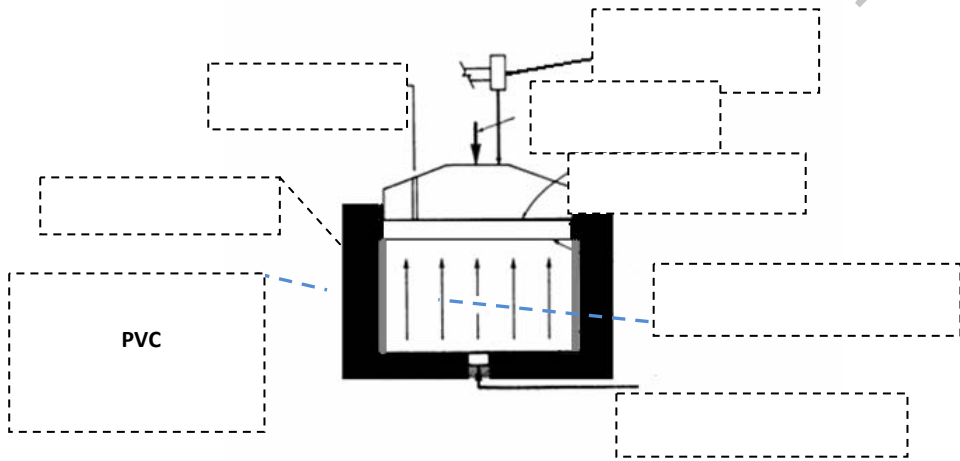
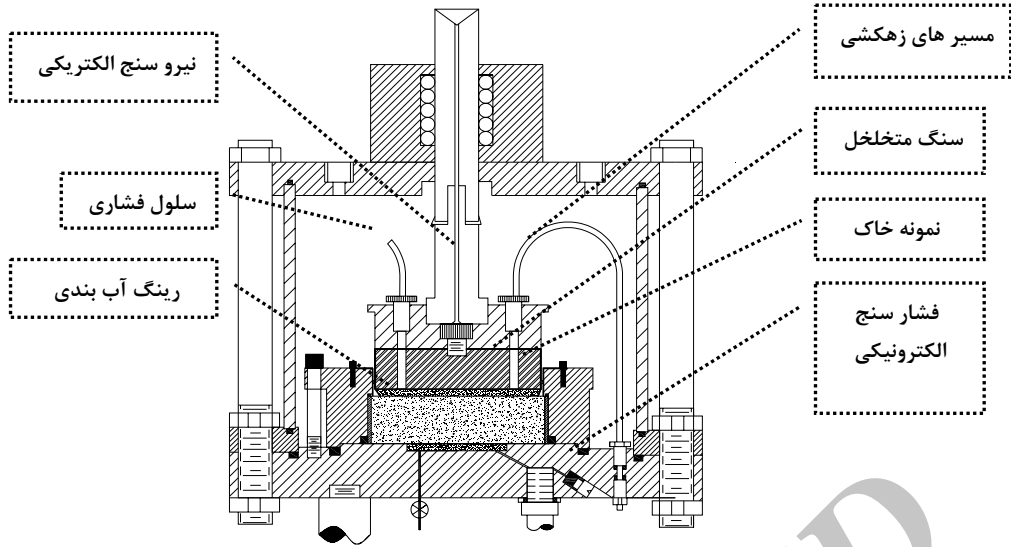

1D 1C 1B 1A

( ) ( )

( )

( ) ( )

( )

0.025%/mm

0.025%/min

0.025%/mm

0.025%/mm

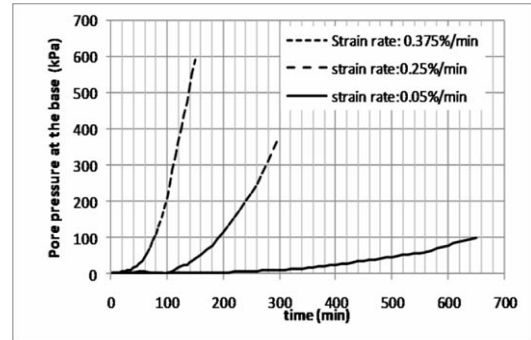
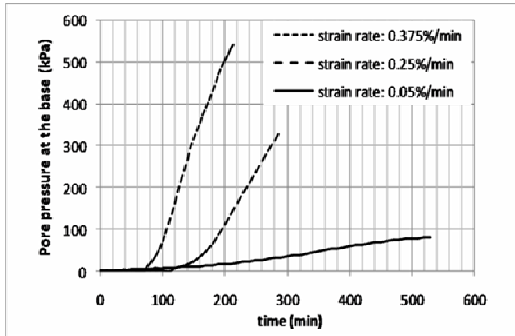

B

A

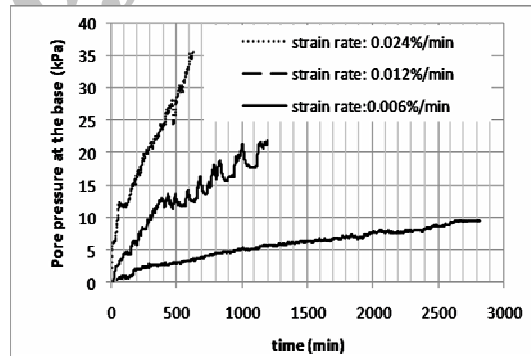
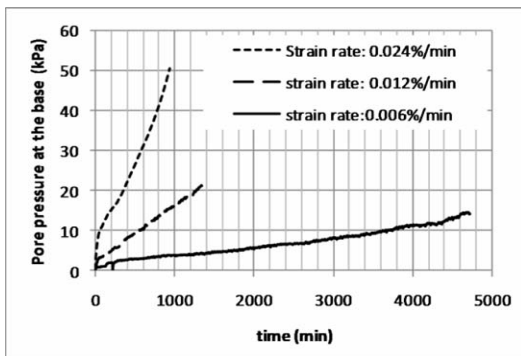

D

C

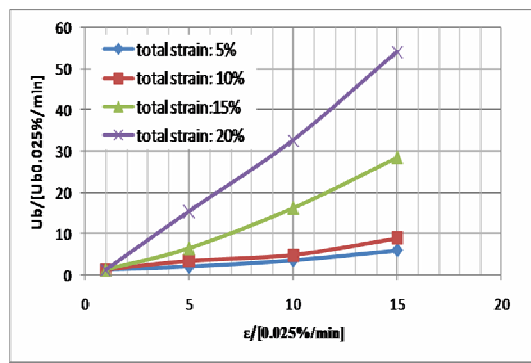
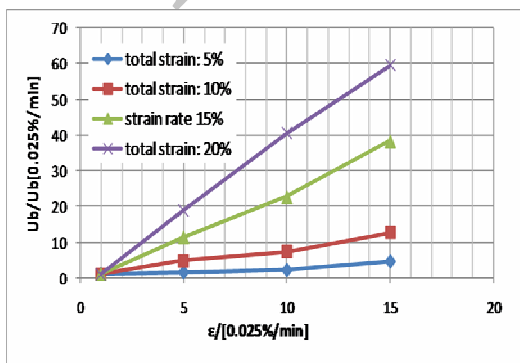

B

0.025%/min

A

0.025%/min

( ) ( )

( )

0.001%/min

( ) ( ) ( )

B A

D C

B A

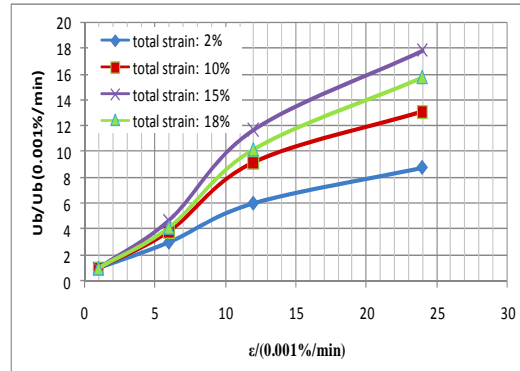
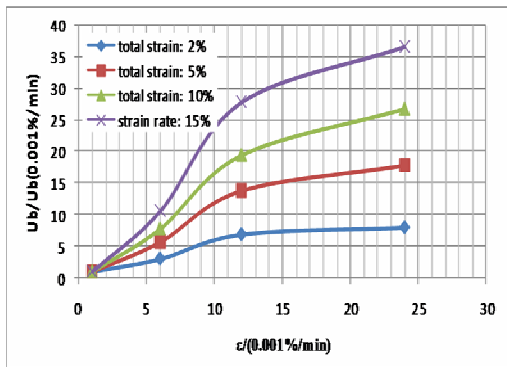

0.001%/min

D

0.001%/min

C

( ) ( )

Archive 01

( ) ( )  $(u_b/\sigma)$

( ) ( )

B A

( )

( ) ( )

D C

C

( )

D

C

B A

C

C

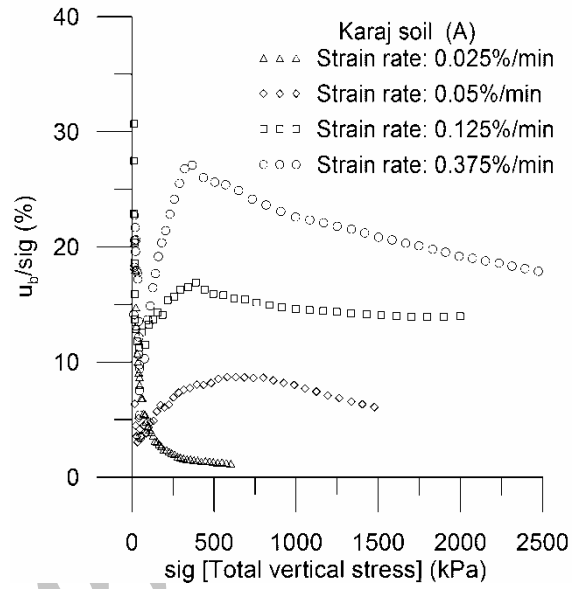
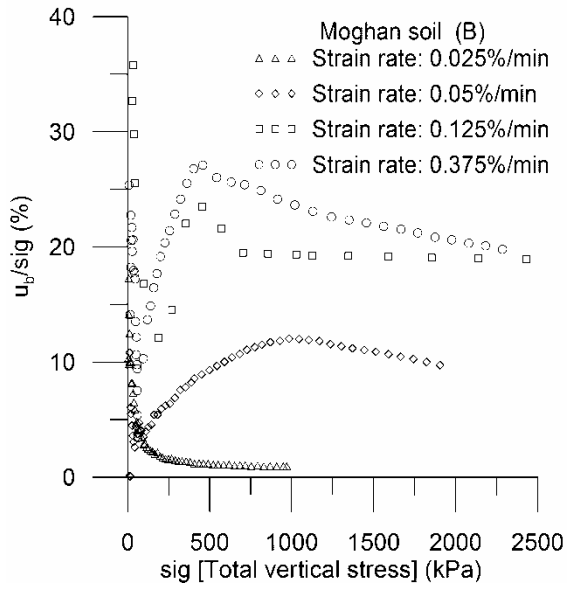

B

A

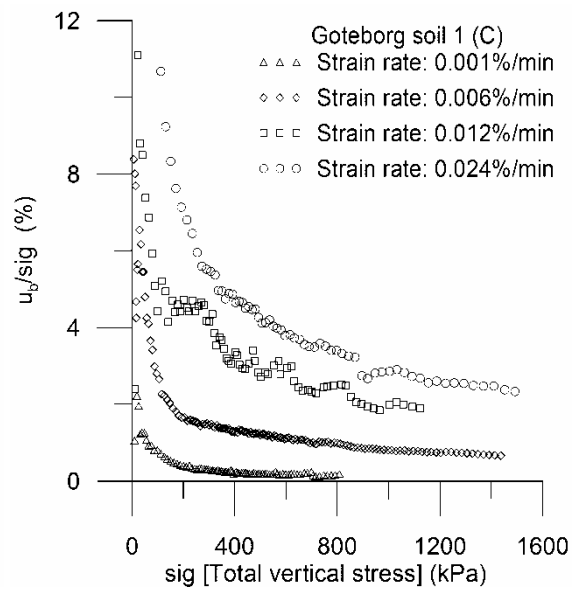
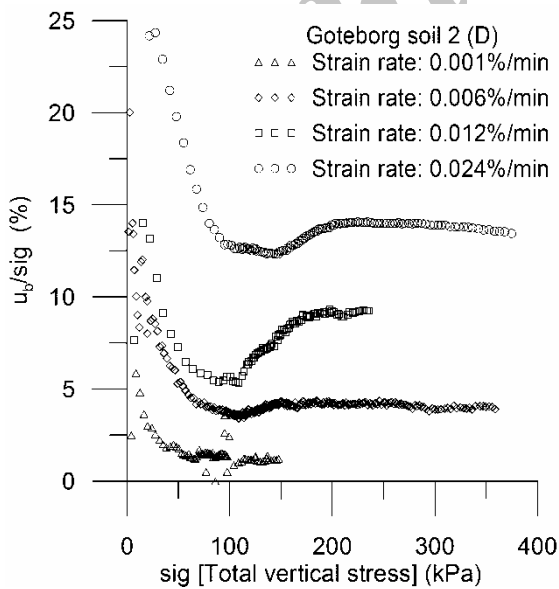

D

C

( )

B A

D

( ) ( ) ( )

CRS

( )

CD

(Dubak, 2003)

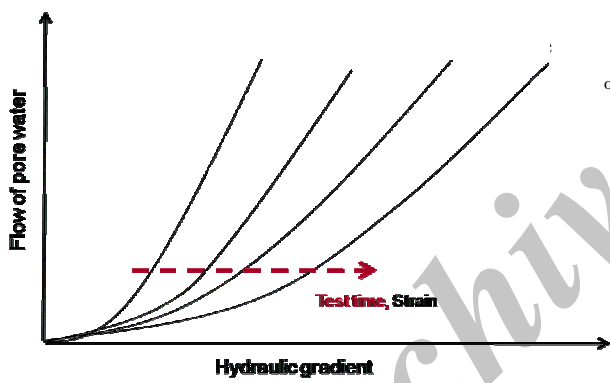

Mitchell and Younger, )

(1967

$e_0$

$e_f$

( ) Hansbo

)

(

Seah and )

(Juirnarongrit, 2003

CRS

v-i

(i)

(v)

( )

v-i

( ) ( )

( )

( )

( )

(Mitchell and Soga, 2005)

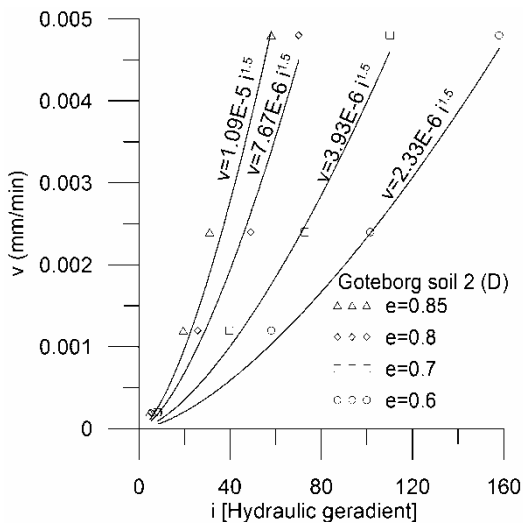

(PI=66) D

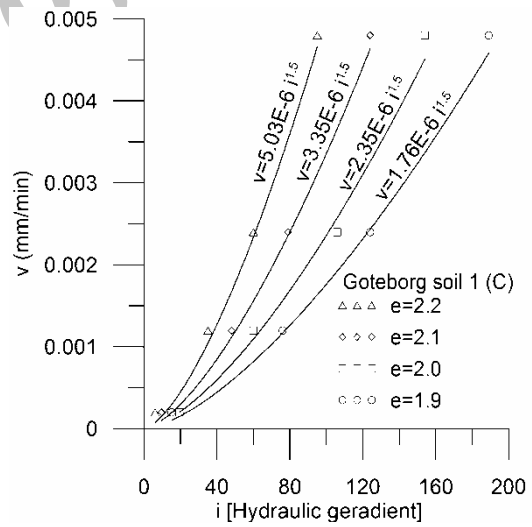

(PI=60) C

v-i

v-i

(Hansbo, 1960; 2001; 2003)

/



$$(u_b/\sigma)$$

CRS

(CL)

%

( )

(CL)

(CH)

CRS

## REFERENCES

- Almeida, M. S. S., Martins, I. S., and Carvalho S. R. L., (1995) *Constant Rate of Strain Consolidation of Singapore Marine Clay* discussion to paper (ed Lee., K. et all.) *Geotechnique*, 45 (2) 333-336.
- ASTM, (2002) *Annual Book of ASTM Standards*, American Society for Testing and Materials, Soil and Rock, D4186-89, 500-505.
- Brown, G. O., Garbrecht, J. D., and Hager, W. H. (2003) Henry P. G. Darcy and Other Pioneers in Hydraulics: Contributions in Celebration of the 200th Birthday of Henry Philibert Gaspard Darcy, ASCE, Reston, VA. Dobak, P., 2003. Loading Velocity in Consolidation Analysis *Geological Quarterly*, 47 (1):1320.
- Dobak, P., (2003) Loading Velocity in Consolidation Analysis. *Geological Quarterly*, 47 (1):13-20.
- Dubin, B. and Mulin, G., (1986) *Influence of a Critical Gradient on the Consolidation of Clays, Consolidation of Soils: Testing and Evaluation*, ASTM SPT 892, R. N. Yong and F. C. Townsend, Eds., American Society for Testing and Materials, pp. 354-377.
- Gorman, C. T., Hopkins, T. C., Deen, R. C., and Drenvich, V. P., (1978) *Constant rate of strain and controlled gradient consolidation testing Geotech. Testing Journal.*, 1(1) 3-15.
- Hamilton, J.J., and Crawford, C.B., (1959) Improved Determination Preconsolidation Pressure of a Sensitive Clay Papers on soils, ASTM Spec. Tech. Publ. No. 254-270.
- Hansbo, S. (1960) Consolidation of clay, with Special Reference to Influence of Vertical Sand Drains. *www.SID.ir*

- study Made in Connection with Full Scale Investigations at Ska<sup>o</sup>-Edeby. Doctoral thesis, *Swedish Geotechnical Institute*.
- Hansbo, S., (2001) Consolidation Equation Valid for Both Darcian and Non-Darcian Flow, *Geotechnique* 51 No. 1, 51-54.
- Hansbo, S., (2003) Deviation from Darcy's Law Observed in One-Dimensional Consolidation *Geotechnique* 53 No. 3, 601-605.
- Lee, K. and Choa, V., Lee, S. H., and Quek, S. H., (1993) Constant Rate of Strain Consolidation of Singapore Marine Clay. *Geotechnique*, 43 (3): 471-488.
- Mitchell, K. J., and Soga, K., (2005) *Fundamental of soil behaviors* third edition, Wily and Sons.
- Mitchell, K. J. and Younger, J. S., (1967) *Abnormalities in hydraulic flow through fine-grained soils.* in Idriss, I. M. (Ed), 2001. Selected geotechnical papers of James K. Mitchell, ASCE pp.142-178.
- Salfors, G., (1975) *Perconsolidation pressure of soft highly plastic clays.* Chalmers Univ. Tech. Goteborg.
- Seah, H. T., and Juirnarongrit, T., (2003) Constant rate of strain consolidation with radial drainage, *Geotechnical Testing Journal*, Vol. 26, No.4
- Sheahan, T. C., and Watters, P. J., (1997) Experimental verification of CRS consolidation theory *J. of Geotechnical and Geoenvironmental Eng.* Vol. 123, No. 5, 430-437.
- Smith, R. E. and Wahls, H. E., (1969) Consolidation under constant rate of strain, *Journal of Soil Mech. Fund. Div.*, 95 (SM 2).
- Wissa, A. E. Z., Christian, J. T., Davis, E. H., and Heiberg, S., (1971) Consolidation testing at constant rate of strain *J. of Soil mechanic and foundation Div., ASCE*, 97 (10), 1393-1413
- Younes, Y. C., and Chung, K. C., (2005) Consolidation test at constant rate of strain for radial drainage, *Geotechnical Testing Journal*, Vol. 28, No.1

Archive of SID