(AZ91C)

*

(// // //)

[]

AZ91C

()

()

m/s

/ m/s

- AZ91C -

-

-

:

[]

[]

[]

[]

$$\rho v^2 = \frac{2\gamma}{r}$$

() () .[]

$$v = \sqrt{\frac{2\gamma}{\rho r}}$$

() .[]

)
(

.[]

$$\rho = 1590 \text{ kg/m}^3 \quad \gamma = 0.595 \text{ m/s}$$

m/s

.[]

/ - /

AZ91C

/ /

Runyoro

/ m/s

/ m/s mm

Halvae .[]

/ m/s

AZ91C

(ZK51)

Bahrinian .[]

()

/ m/s

/ m/s"

mm

(Plate)

mm

.[]

()

CO₂

.[-]

()

ρv^2

v

ρ

mm

mm

$$\frac{2\gamma}{r}$$

γ

r)

(mm)

(mm)

(mm)

:

$$h_c = (21.0 + 2.0) - 4.0 = 19.0 \text{ mm}$$

()

:

$$V = \frac{\Delta h}{\Delta t}$$

(ع)

$$V = \sqrt{2gh_e}$$

()

$$V = (2 \times 10 \times 19.6 / 1000)^{1/2} = 1.98 \text{ m/s}$$

(د)

SO₂

Sony Mini Dv

[] E-290 ASTM

cm

Phoenix 2500

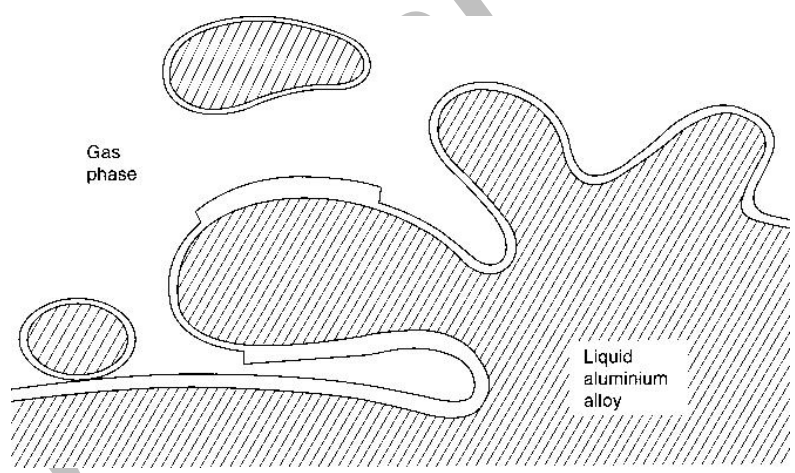

[]

Reasercher	Alloy	Thickness	velocity m/s	year
Eastwood, Grube	Al-10Mg	6mm	0.5	1950
Suzuki	Al		0.4	1998
Runyoro, Campbell	Al	5mm	0.5	1992
Halvae, Campbell	Cu-10Al	10 mm	0.375	1995
Bahrinian, Buotorabi	ZK51		0.5	1996

. AZ91C

AZ91	Al	Mn	Zn	Mg
Composition	8.7	0.5	0.1	Base

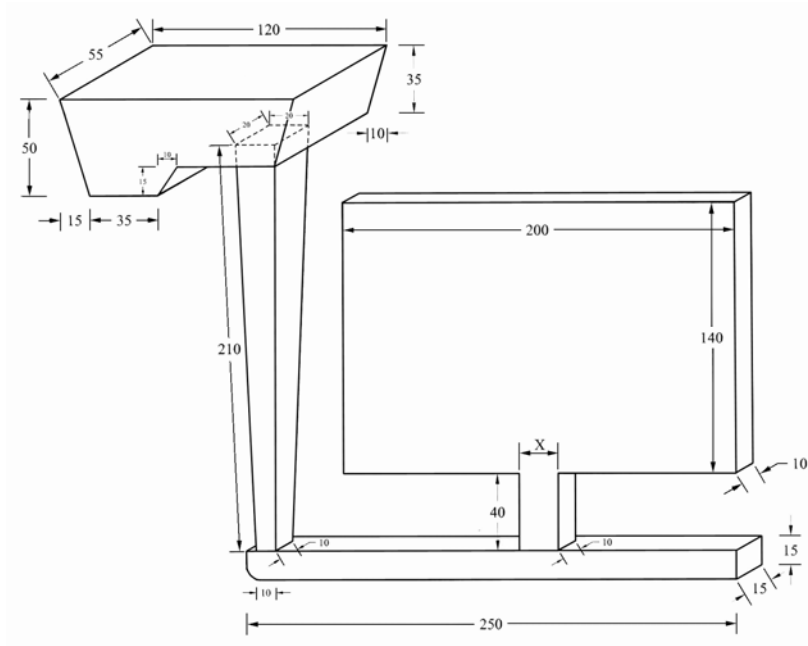

() :

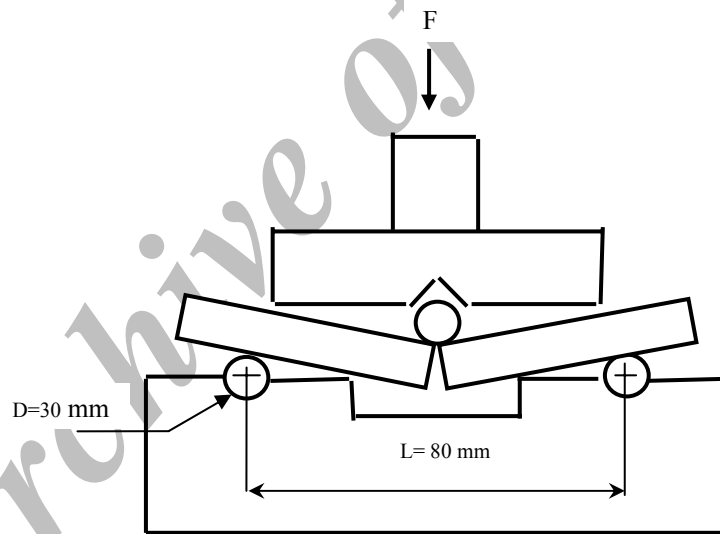

Type of Radiation	X
Distance of beam generation source to sample surface	60 cm
Voltage	130 KV
Current	5 mA

()

()

() ()
 () . []
 ()

() () ()
 SEM

() EDX

. cm :

Number of Sample	1	2	3	4	5	6
Theoretical Velocity (m/s)	3.3	2	1.5	1	0.8	0.66
Real Velocity (m/s)	1.2	1	0.6	0.5	0.35	<0.25
Chock Cross Section (mm ²)	100	100	100	100	100	100
Gate Cross Section (mm ²)	70	100	150	200	250	300
Flow Rate(m ³ /s)*10 ⁻⁶	90	100	90	100	87.5	75
Friction loss %	64	50	60	50	57	62
Coefficient of Discharge (μ)	0.36	0.5	0.4	0.5	0.43	0.38

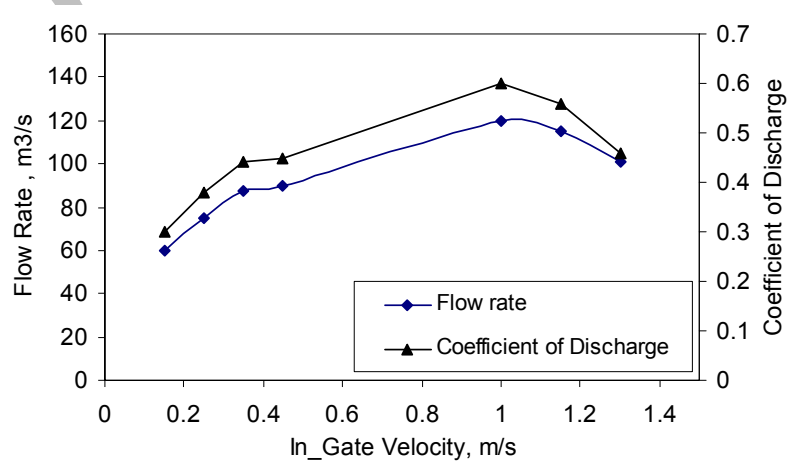

:

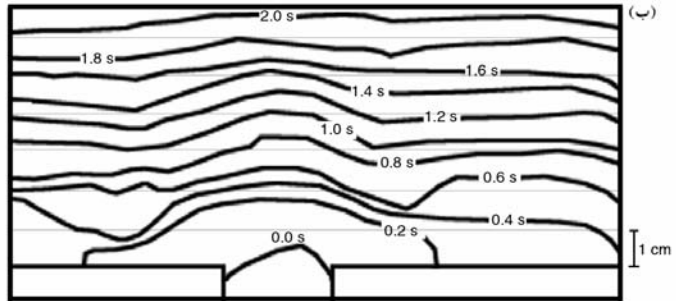
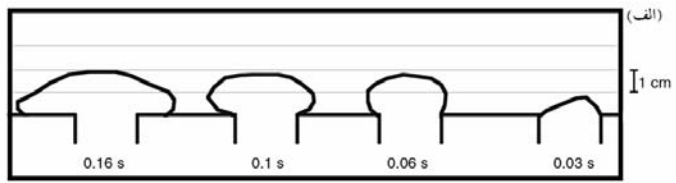

(/ m/s) () :
 .[] ()

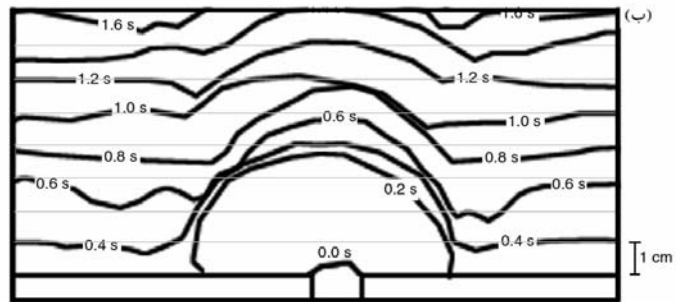
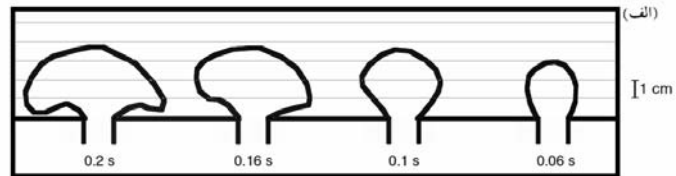

(/ m/s) () :
 .[] ()

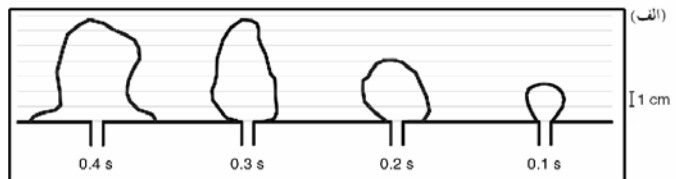

(/ m/s) () :
 .[] ()

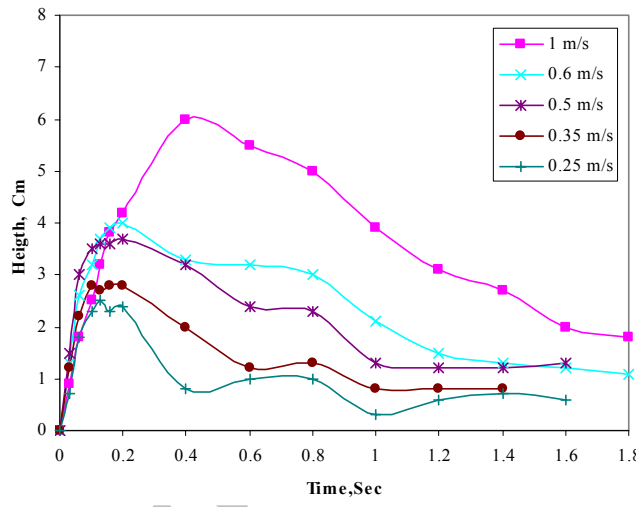
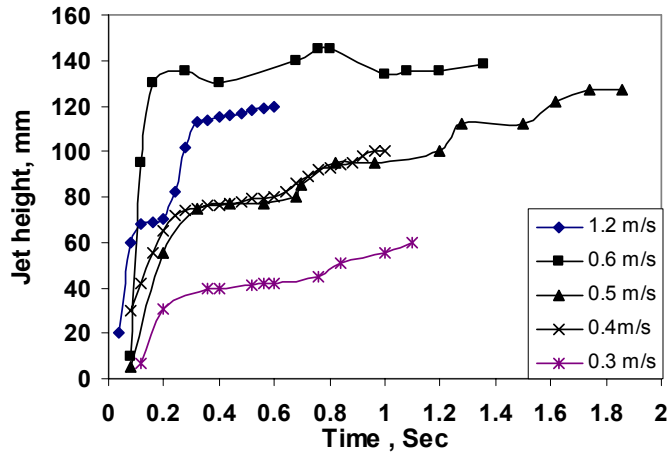

Archu

() / m/s

() / m/s

() / m/s

() / m/s

cm

()

()

()

(cm)

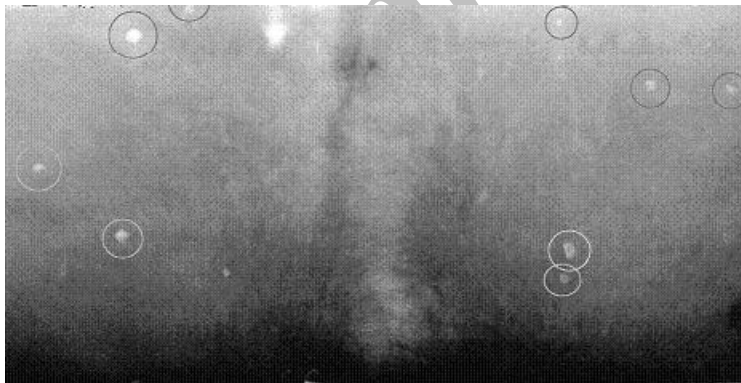

()

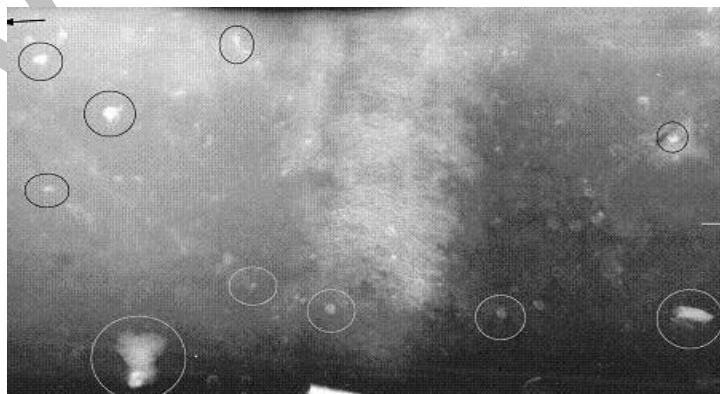

()

/ m/s (/ m/s (:
())

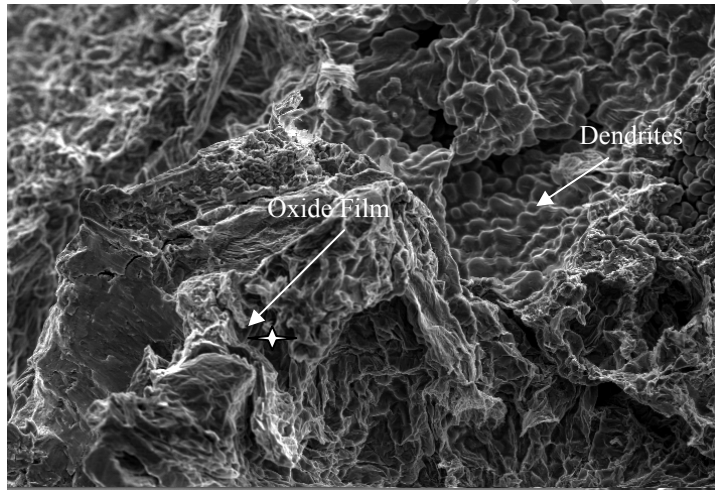
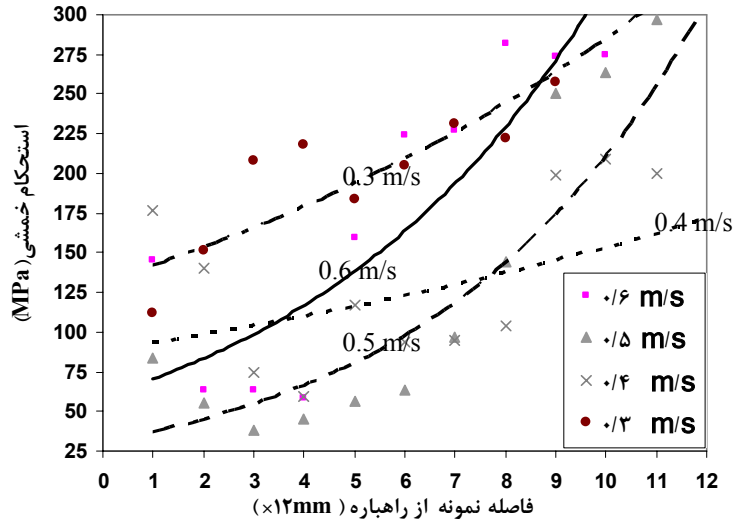

SEM :

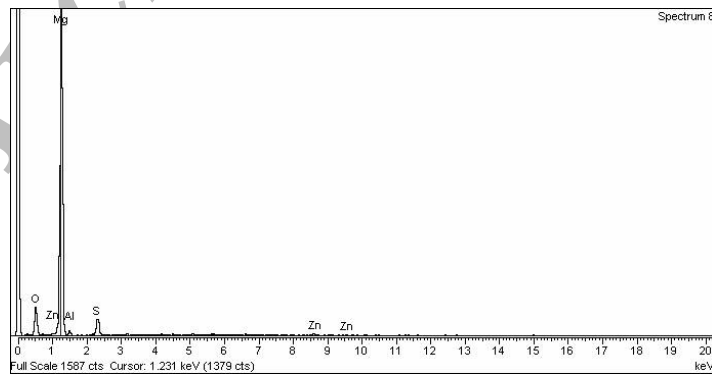

EDX :

()

/ m/s

.()

SEM (-)
)
 (-) EDX .(
 /
 / m/s
 m/s
)
)
 ()
 .(

- 1 - Campbell, J. (2003). *Castings*, Oxford, Butterworth, Heinemann.
- 2 - Nyahumwa, C., Green, N. R. and Campbell, J. (1998). *AFS Trans.*, PP. 215 – 223.
- 3 - Divandari, M. and Campbell, J. (2004). *Int. J. of Cast Metals Research*, Vol. 17, PP.1-6.
- 4 - Emley, E. F. (1966). *Principles of magnesium technology*, Pergamon Press.
- 5 - Runyoro, J., Boutorabi, S. M. A and Campbell, J. (1992). *AFS Transaction*, Vol.37, PP. 255-234.
- 6 - Halvae, A. and Campbell, J. (1997). *AFS*, 97-18, PP. 350.
- 7 - Bahrinian. F., Boutorabi, S. M. A. and Campbell, J. (2005). *The June Campbell Symposium*, TMS, PP.463-474.
- 8 - Grube, K. and Eastwood, L. W. (1950). *AFS Transactions*, PP.76-107.
- 9 - Suzuki, S. (1989). *Modern Casting*, October 38-40.
- 10 - ASTM Standard, E 290-97a, (2000). *Standard Test Method Bend testing of Material and ductility*.
- 11 - Zebardast, M., Khorasani, S., Divandari, M. and Boutorabi, S. M. A. (1384). *Effect of In Gate Velocity on Mechanical Properties of Magnesium Alloy Casting (AZ91)*, B. S. Thesis, The University of Science and Technology of Iran, Materials and Metallurgy Eng. Dept.