

(/ / , / / / / /)

Archive of SID

()

T-Stub []

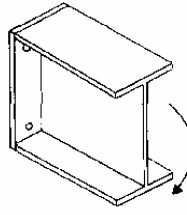

(a)

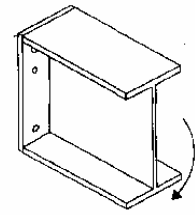

(b)

T-Stub

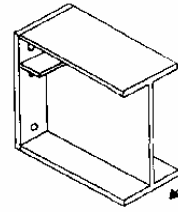

(c)

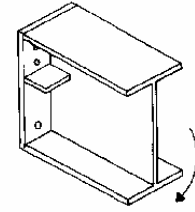

(d)

[]

[] Eurocode3

[]

Eurocode3

T-Stub

Eurocode3

Eurocode3

[]

[]

[]

()
()

SOLID45

		(mm)			
M20	grade 8.8	12	203*203*86 UC	254*146*37 UB	EP4
M16	grade 8.8	20	203*203*86 UC	254*146*37 UB	EP7

() ()

ANSYS

CONTACT174 SOLID45

8.1

TARGE170

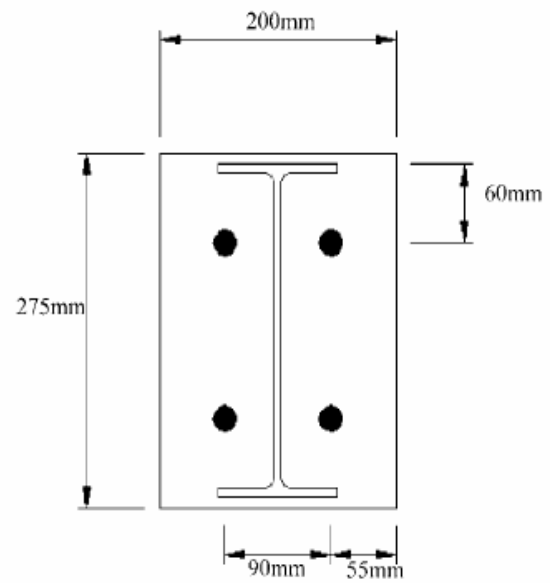
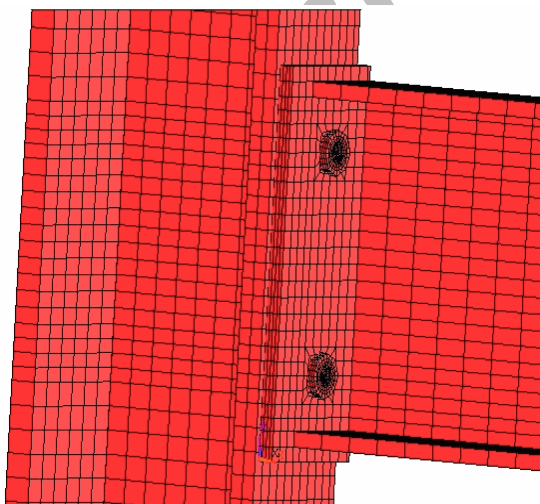
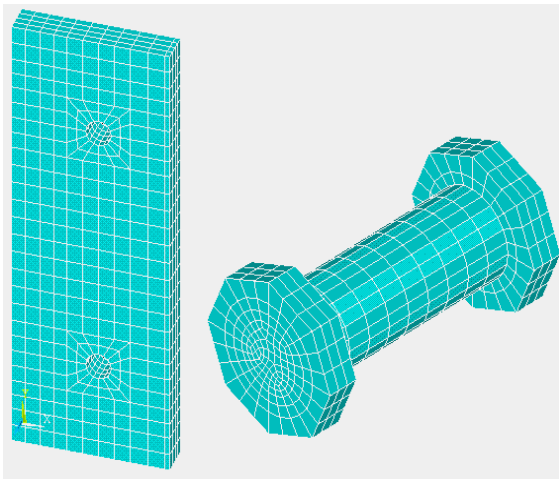

.EP7 EP4

:

%

[] ECCS

()

CONTACT174

dy

N

SOLID45

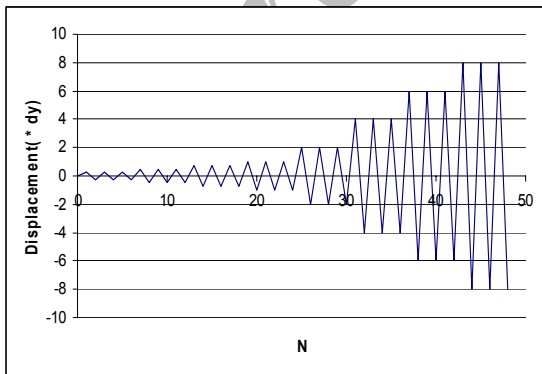
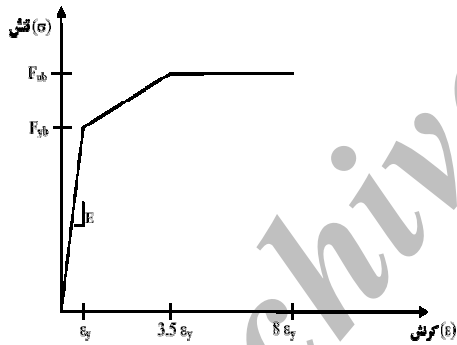
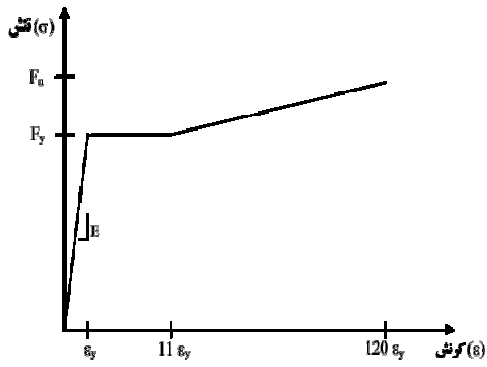

()

()

Mpa

Mpa

Mpa

Mpa

()

[]

()

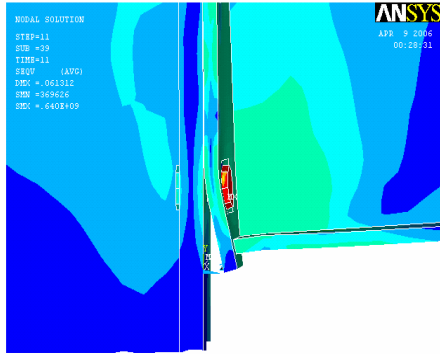

EP4

() ()

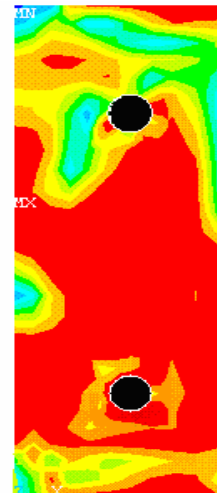
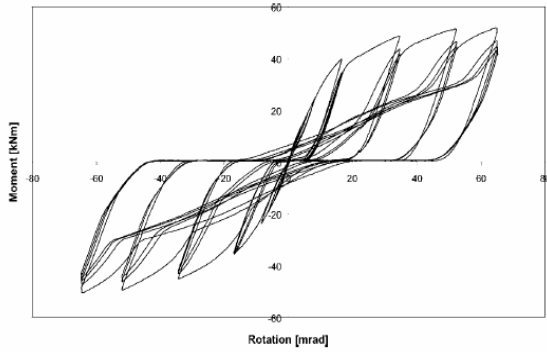

EP4

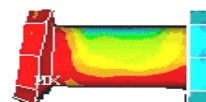
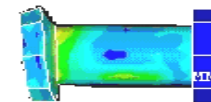
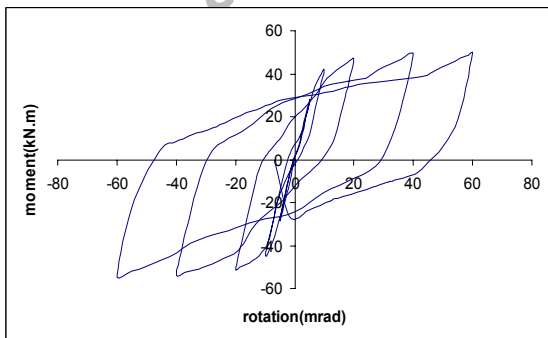

EP4

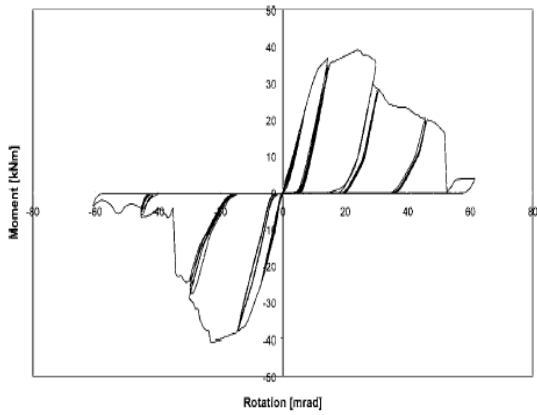

()

EP4

kN.m rad.

.EP7

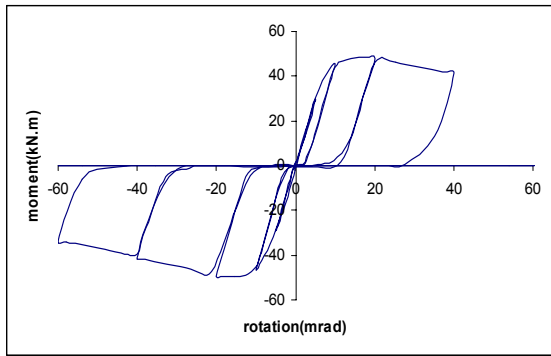

.EP7

.EP7

9.1	0.0100	0.0110	θ_y	
15.2	40.70	35.33	M_y	
23.7	4070	3290	M_y/θ_y	
7.6	0.0220	0.0238	θ_u	
12.3	44.80	39.90	M_u	
1.8	2.20	2.16	θ_u/θ_y	
6.2	0.0120	0.0128	θ_p	

EP4

3.8	0.0100	0.0104	θ_y	
14.1	42.00	36.81	M_y	
18.3	4200	3550	M_y/θ_y	
7.7	0.0600	0.0650	θ_u	
2.8	53.30	51.86	M_u	
4.8	6.00	6.30	θ_u/θ_y	
9.1	0.0500	0.0550	θ_p	

()

()

EP7

$$M_{pl} = F_{py} t_p^2 \left\{ (h - p_t) \left[\left(\frac{b_f}{2} \right) \left(\frac{1}{p_f} + \frac{1}{s} \right) + (p_f + s) \left(\frac{2}{g} \right) \right] \right\} \quad ()$$

EP7

()

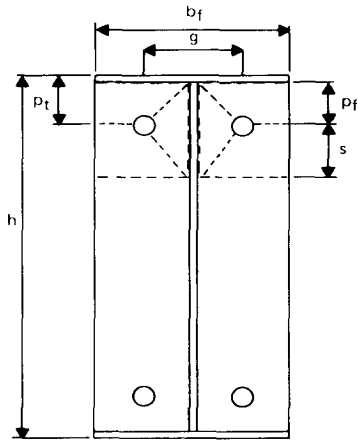

Eurocode3

[]

Eurocode3

FEMA350

[] FEMA350

$$s = \frac{1}{2} \sqrt{b_f \cdot g}$$

s

()

[]

[]

[]

Split-Tee

(t_p)

(M_u)

T

(M_{pl})

(F_{py})

$$t_p = \left[\frac{M_u / F_{py}}{(h - p_t) \left[\left(\frac{b_f}{2} \right) \left(\frac{1}{p_f} + \frac{1}{s} \right) + (p_f + s) \left(\frac{2}{g} \right) \right]} \right]^{1/2}$$

()

$$Q = \frac{F_f p_f}{2a} - \frac{b_f t_p^2}{8a} \sqrt{F_{py}^2 - 3 \left[\frac{F_f}{b_f t_f} \right]^2} - \frac{\pi d_b^3 F_{yb}}{32a} \quad (1)$$

$$a = \frac{9352}{100} \left(\frac{t_p}{d_b} \right)^3 - \frac{2159}{1000} \quad (2)$$

$$B = \frac{F_f}{2} + Q \quad (3)$$

$$F_f = M_u / (d - t_f) \quad (4)$$

$$t_{11} > t_p \quad (5)$$

$$Q_{\max} = \frac{w' t_p^2}{4a} \sqrt{F_{py}^2 - 3 \left(\frac{F'}{w' t_p} \right)^2} \quad (6)$$

$$F_{Limit} = \frac{t_p^2 F_{py} (0.85 b_f / 2 + 0.8 w') + \pi d_b^3 F_{yb} / 8}{4 p_f} \quad (7)$$

$$t_1 = \sqrt{\frac{4 p_f F_f}{b_f \sqrt{F_{py}^2 - 3 \left(\frac{F_f}{b_f t_1} \right)^2}}} \quad (8)$$

$$F_{\max} = \frac{F_f}{2} \quad (9)$$

$$t_p > t_1 \quad (10)$$

$$B = \frac{F_f}{2} + Q_{\max} \quad (11)$$

$$B = \frac{F_f}{2} \quad (12)$$

$$t_{11} = \sqrt{\frac{2(F_f p_f - \pi d_b^3 F_{yb} / 16)}{\frac{b_f}{2} \sqrt{F_{py}^2 - 3 \left(\frac{F_f}{b_f t_{11}} \right)^2} + w' \sqrt{F_{py}^2 - 3 \left(\frac{F_f}{2 w' t_{11}} \right)^2}} \quad (13)$$

$$w' \quad d_b \quad F_{yb} \quad t_{11} \quad t_p \quad t_p > t_{11} \quad (14)$$

$$() \quad (Q)$$

()

[]

()

() ()

()

EPN8 EPN1

	(h)
	(b _f)
	(p _f)
	(g)
	(w ²)
/	(t _f)
	(d)
	(F _{py})

	(t _p)	(d _b)	(F _{yb})	(t _l)	(t _{ll})		(M _{pl})	(M _{bu})
EPN1	12	20	640	35	26		45	70
EPN2	12	20	900	39	29		45	103
EPN3	12	25	640	37	27		45	78
EPN4	20	16	900	37	28		126	78
EPN5	20	25	640	46	34		126	116
EPN6	20	20	640	37	28		126	79
EPN7	20	20	900	46.5	35		126	119
EPN8	16	20	640	36	27		80.7	74

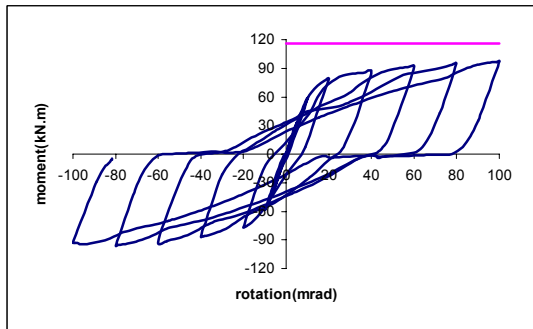

.EPN5 :

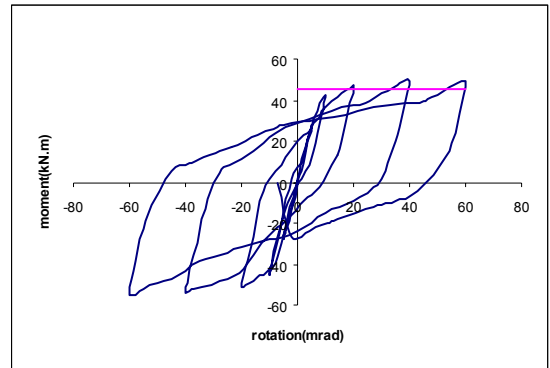

.EPN1 :

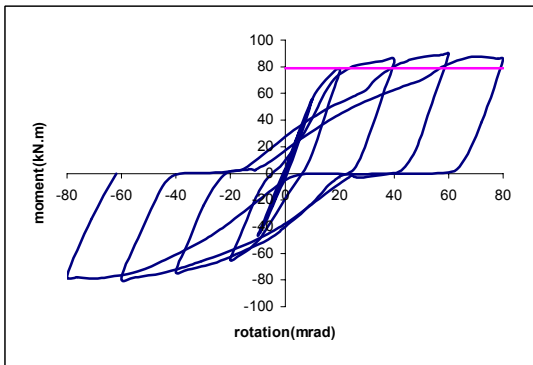

.EPN6 :

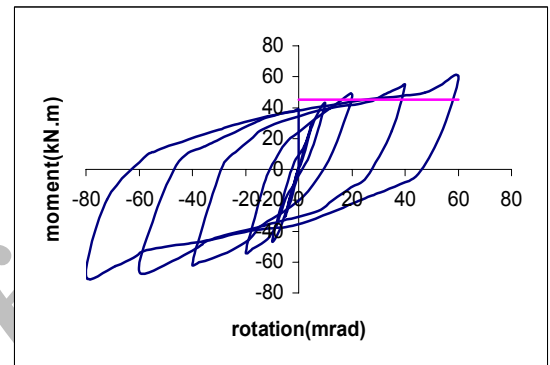

.EPN2 :

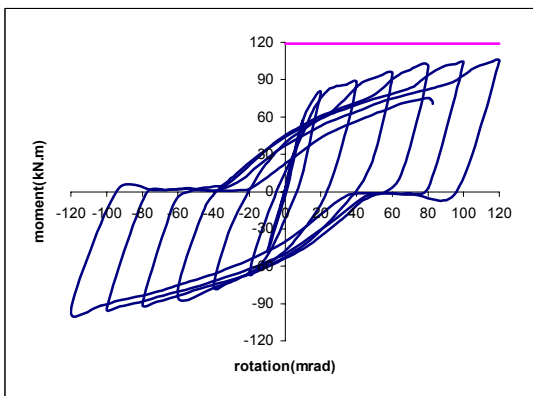

.EPN7 :

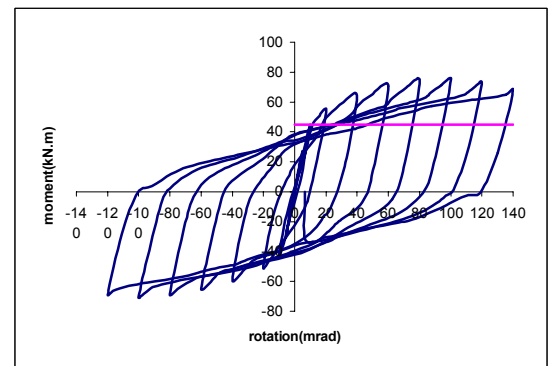

.EPN3 :

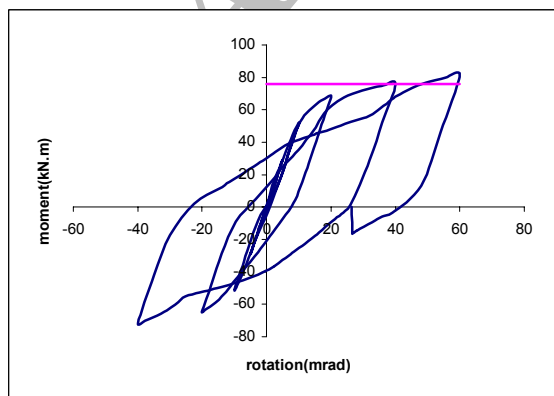

.EPN8 :

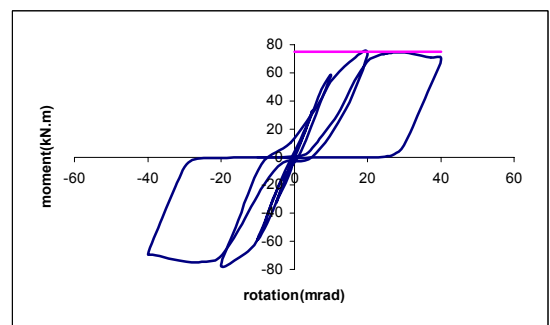

.EPN4 :

()

EPN7 EPN5

)

(EPN8 EPN6 EPN4 EPN1

EPN2)

(EPN3

	(M_y)	(M_u)	(M_u)	I
EPN1	40.5	50	45	0.90
EPN2	39	69	45	0.65
EPN3	44	75	45	0.60
EPN4	49	79	78	0.99
EPN5	55	98	116	1.18
EPN6	60	82.5	79	0.96
EPN7	59	105	119	1.13
EPN8	51.5	80.5	74	0.92

1 - European committee for standardization, (1998). Eurocode 3: part 1.1., Revised Annex J: Joints in building frames, Env 1993-1-1: 1992/A2.

2 - Davison, J. B., Kirby, P. A. and Nethercot, D. A. (1987). "Rotational stiffness characteristics of steel beam to column connections." *Journal of Construction Steel Research*, Vol. 8, PP. 17-54.

-
- 3 - Bose, B. and Hughes, A. F. (1995). "Verifying the performance of standard ductile connections for semi continuous steel frames." *Proceedings of the Institution of Civil Engineers, Structures and Buildings*, Vol. 110, PP. 441-457.
 - 4 - Shi, Y. J., Chan, S. L. and Wong, Y. L. (1996). "Modeling for moment-rotation characteristics for end plate connections." *Journal of Structural Engineering*, Vol. 122, PP. 1300-1306.
 - 5 - Broderick, B. M. (2002). "The response of flush end-plate joints under earthquake loading." *Journal of Constructional Steel Research*, Vol. 58, PP. 1161-1175.
 - 6 - Bahaari, M. (1998). "Numerical modeling of flush endplate bolted connections." *Journal of Faculty of Engineering, University of Tehran*, Vol. 31, No.2, PP. 9-18.
 - 7 - European Convention for Constructional Steelwork (ECCS), (1986). Recommendation testing procedure for assessing the behavior of structural steel elements under cyclic loading. In: Technical Committee 1: Structural Safety and Loading.
 - 8 - Thomson, A. W. and Broderick, B. M. (2000). "Seismic resistance of flush end-plate connections." *The Structural Engineer*, Vol. 78, No. 17, PP. 28-33.
 - 9 - FEMA (2000). FEMA-350, Recommended Seismic Design Criteria for New Steel Moment Frame Buildings, Federal Emergency Management Agency, Washington D.C., U.S.A.
 - 10 - Srouji, R., Kukerti, A. R. and Murray, T. M. (1983). "Yield-Line analysis of end-plate connections with bolt force predictions." *Research Report No. FSEL/MbMA 83-05*, Fears Structural Engineering Laboratory, School of Civil Engineering Laboratory, School of Civil Engineering and Environmental Science, University of Oklahoma, Norman, Oklahoma, U.S.A.
 - 11 - Kennedy, N. A., Vinnakota, S. and Sherbourne, A. N. (1981). "The split-tee analogy in bolted splices and beam-column connections." *Proceedings of The International Conference on Joints in Structural Steelwork; The Design and Performance of Semi-Rigid and Rigid Joints in Steel and Composite Structures and Their Influence on Structural Behavior*, Teesside Polytechnic, Middleborough, U.K., PP. 2.138-2.157.

- 1 - High Strength Bolt
- 2 - Pre-tension
- 3 - Flush End-plate
- 4 - Extended End-plate
- 5 - Monotonic Loading
- 6 - Yield Line Theory
- 7 - Cyclic Loading
- 8 - Hysteresis
- 9 - Prying Force